

APJ ABDUL KALAM  
TECHNOLOGICAL  
UNIVERSITY

**SEMESTER VII**

KTU



CODE	COURSE NAME	CATEGORY	L	T	P	CREDIT
MET401	DESIGN OF MACHINE ELEMENTS	PCC	2	1	0	3

**Preamble:** This course focuses on important topics in design of machine elements. It covers the topics of shaft design with due consideration based on strength and rigidity. The course also includes the design procedure of flat belts and connecting rod of IC engines. The other topics included are journal bearings design, ball and roller bearings, spur gear and helical gear design considerations. The syllabus also covers design procedure of bevel gear and worm gear.

**Prerequisite:** MET304 Dynamics and Design of Machinery

**Course Outcomes:** After the completion of the course the student will be able to:

CO 1	Design shafts based on strength, rigidity and design for static and fatigue loads, design flat belts and connecting rod of IC engines
CO 2	Design clutches and brakes
CO 3	Analyse sliding contact bearings and understand design procedure of journal, ball and roller bearings.
CO 4	Design Spur gear and helical gear
CO 5	Design Bevel gears and worm gears

**Mapping of course outcomes with program outcomes**

	PO 1	PO 2	PO 3	PO 4	PO 5	PO 6	PO 7	PO 8	PO 9	PO 10	PO 11	PO 12
CO 1	3	3	3									
CO 2	3	3	3									
CO 3	3	3	3									
CO 4	3	3	3									
CO 5	3	3	3									

**Assessment Pattern**

Bloom's Category	Continuous Assessment Tests		End Semester Examination
	1	2	
Remember			
Understand	20	20	30
Apply	30	30	70
Analyse			
Evaluate			
Create			

**Mark distribution**

<b>Total Marks</b>	<b>CIE</b>	<b>ESE</b>	<b>ESE Duration</b>
150	50	100	3 hours

**Continuous Internal Evaluation Pattern:**

Attendance : 10 marks  
 Continuous Assessment Test (2 numbers) : 25 marks  
 Assignment/Quiz/Course project : 15 marks

**End Semester Examination Pattern:** There will be two parts; Part A and Part B. Part A contain 10 questions with 2 questions from each module, having 3 marks for each question. Students should answer all questions. Part B contains 2 questions from each module of which student should answer any one. Each question can have maximum 2 sub-divisions and carry 14 marks.

**Course Level Assessment Questions****Course Outcome 1 (CO1):**

1. What is critical speed of a shaft?
2. What are the causes of failure in shafts?
3. Differentiate between torsional rigidity and lateral rigidity of shaft.
4. Enumerate the various types of flat belt drives.
5. Explain why I section is usually preferred in the case of a connecting rod?

**Course Outcome 2 (CO2)**

1. What is the function of a clutch?
2. Why are cone clutches better than disc clutches?
3. What is the principle of operation of a centrifugal clutch? What are its applications?
4. What are the advantages and disadvantages of band brake?
5. What are the types of brake lining?

**Course Outcome 3 (CO3):**

1. Explain hydrodynamic theory.
2. Discuss the significance of bearing modulus in the design of journal bearing?
3. Briefly describe the design procedure of Journal bearings
4. Define static and dynamic load carrying capacity of ball bearing.

5. What is  $L_{10}$  and  $L_{50}$  life of ball bearing?

**Course Outcome 4 (CO4):**

1. State and explain law of gearing.
2. Give an account on different modes of failure of gear tooth.
3. Explain why dynamic factors need to be considered in the design of gears.
4. Explain interference and undercutting in gears
5. What are the advantages of helical gears over spur gears?
6. What is beam strength in case of helical gears?

**Course Outcome 5 (CO5):**

1. What are the uses of bevel gears?
2. Classify bevel gears.
3. What is formative number of teeth in case of bevel gears?
4. What are the characteristics of worm gears?
5. Enumerate the applications of worm gears?
6. Describe the design procedure of worm gears?



**Model Question Paper****APJ ABDUL KALAM TECHNOLOGICAL UNIVERSITY****VII SEMESTER BTECH DEGREE EXAMINATION****MET401: DESIGN OF MACHINE ELEMENTS**

Maximum: 100Marks

Duration:3 hours

*Use of Machine Design Data Book is permitted.***PART A**

Answer all questions, each question carries 3 marks

1. Compare the strength and stiffness of a hollow shaft of same outside diameter as that of a solid shaft.
2. Explain about the material for used for flat belts
3. How clutch is different from coupling?
4. What are the requirements for a good friction material used for the brakes?
5. What are the types of lubrication for bearings?
6. What are the causes of bearing failure?
7. Draw a neat sketch and indicate terminology used in spur Gear
8. What is virtual or equivalent number of teeth in case of helical gears?
9. What is a herringbone gear? What are its advantages?
10. Why a worm set can only be used as jack and hoists for raising loads. (10×3=30Marks)

**PART B***Answer one full question from each module***MODULE 1**

11. a) A shaft is supported by two bearings 1 m apart. A 600 mm diameter pulley is mounted at a distance of 300 mm to the right of left hand bearing and this drives a pulley directly below it with the help of a belt having maximum tension of 2.25 kN. Another pulley 400 mm diameter is placed 200 mm to the left of right hand bearing and is driven with the help of electric motor and belt, which is placed horizontally to the right. The angle of contact for both the pulley is 180° and  $\mu=0.24$ . Determine the suitable diameter for a solid shaft .The allowable working stress is 63 MPa in tension and 42 MPa in shear for the material of the shaft. Assume that the torque on one pulley is equal to that on the other pulley. (10 marks)
- b) Differentiate between torsional rigidity and lateral rigidity of shaft. (4 marks)

12. Design a flat belt drive for a compressor running at 670 rpm, which is driven by a 25 kW, 1340 rpm motor. Space is available for a centre distance of 3 m. The belt is open type.

(14 marks)

**MODULE 2**

13. a) Determine the main dimensions of a cone clutch faced with leather to transmit 30 kW at 750 rpm from an electric motor to an air compressor. Assume an over load factor of 1.75. Due to possibility of contamination of lining, a low value of coefficient of friction 0.2 is recommended. (11 marks)

b) Distinguish between multiple plate clutch and cone clutch (3 marks)

14. a) A simple band brake as shown in figure below is to be designed to absorb a power of 32 kW at a rated speed of 850 rpm. Assume  $\mu = 0.25$ . Determine, (i) The effort required to stop clockwise rotation of the brake drum, (ii) The effort required to stop counter clockwise rotation of the brake drum, (iii) The dimensions of the rectangular cross-section of the brake lever assuming its depth to be twice the width, and (iv) the dimensions of the cross-section of the band assuming its width to be ten times the thickness. (10 marks)

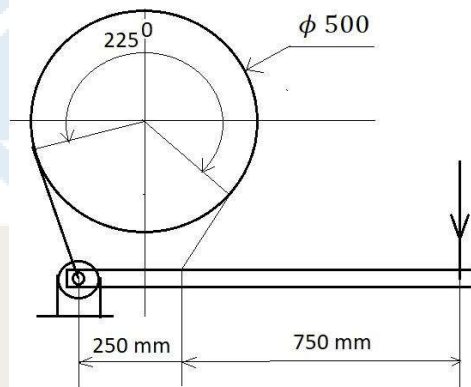

b) What are the different types of brakes? (4 marks)

**MODULE 3**

15. A  $360^\circ$  hydrodynamic journal bearing operates at 1200 rpm and carries a load of 5.5 k N. The journal diameter is 55 mm and length is 55 mm. The bearing is lubricated with SAE 20 oil and the operating temperature of oil is  $79^\circ\text{C}$ . Assume radial clearance as 0.025 mm and the attitude angle as  $60^\circ$ . Determine: (i) bearing pressure, (ii) Attitude, (iii) minimum film thickness, (iv) heat generated, (v) heat dissipated, if the ambient temperature is  $25^\circ\text{C}$ , and (vi) amount of artificial cooling if necessary. (14 marks)

16. a) A single row deep groove ball bearing has a dynamic load capacity of 40210 N and operates on the work cycle consists of radial load of 2000 N at 1000 rpm for 25 % of the time, radial load of 5000 N at 1500 rpm for 50 % of time, and radial load of 3000 N at

700 rpm for the remaining 25 % of time. Calculate the expected life of the bearing in hours. (10 marks)

b) Explain the mechanism of fluid film lubrication (4 marks)

#### MODULE 4

17. A motor shaft rotating at 1440 rpm has to transmit 15 kW power to a low speed shaft running at 500 rpm. A 20° pressure angle full depth involute system of gear tooth is used. The pinion has 25 teeth. Both gear and pinion are made of cast iron having allowable static strength of 55 MPa. Design a suitable spur gear drive and check the design for dynamic load and wear. (14 marks)

18. A helical gear speed reducer is to be designed. The rated power of the speed reducer is 75 kW at a pinion speed of 1200 rpm. The speed ratio is 3:1. For medium shock conditions and 24 hr operation, design the gear pair. The teeth are 20° full depth involute in the normal plane and helix angle is 30°. (14 marks)

#### MODULE 5

19. a) A pair of straight tooth bevel gears at right angles is to transmit 5 kW at 1200 rpm of the pinion. The diameter of the pinion is 80 mm and the speed reduction is 3.5:1. The tooth form is 20° full depth involute. Both the pinion and gear are made of cast iron with allowable stress of 55 MPa. Determine module and face width from the standpoint of strength. And also check the design from the standpoint of dynamic load and wear.

(14 marks)

20. Design a worm gear drive to transmit 20 HP from worm at 1440 rpm to the worm wheel that should be rotated at  $40 \pm 2\%$  rpm. (14 marks)

## Syllabus

### Module 1

Shafting:- material, design considerations, causes of failure in shafts, design based on strength, rigidity, and critical speed, design for static and fatigue loads, repeated loading, reversed bending.

Design of flat belt:- material for belts, slip of the belts, creep, centrifugal tension, Power transmitted by flat belts, Design procedure of flat belts

Design of connecting rod in IC engine.

### Module 2

Design of clutches: -single and multiple plate clutch, cone clutch, centrifugal clutch.

Design of brakes: -band brakes, block brakes, simple and differential band brake, internal expanding shoe brake.

### Module 3

Sliding contact bearing: - lubrication, lubricants, viscosity, journal bearings, hydrodynamic theory, Petroff's equation, bearing characteristic number, Sommerfeld number, Heat generated in bearings, Heat dissipated by bearings, Design procedure of Journal bearings.

Ball and roller bearings: - Types, bearing life, static and dynamic load capacity, Stribeck's Equation, selection of bearings, selection of taper roller bearings, Design procedure of Ball and roller bearings, Needle bearings.

### Module 4

Gears: - Materials of gears, terminology of spur Gear, Interference and undercutting, Gear tooth failures, Beam strength of Gear tooth, Estimation of module, Buckingham's equation for dynamic load, wear load, endurance strength of tooth, Gear proportions, Merits and demerits of each type of gears, Design procedure of Spur gear.

Helical gears: - Terminology, Virtual or equivalent number of teeth, Tooth proportions, Beam strength, and Wear strength of Helical gears, Design procedure of Helical gear

### Module 5

Bevel gears: - Classification, Terminology, Pitch angle for bevel gears, Strength of bevel gear, beam strength, wear tooth load, Formative number of teeth, Design procedure of Bevel gear.

Worm gears: - Characteristics of worm gears, Terminology, Advantages and disadvantages, Applications, Terms in Worm gear, Strength of Worm gear, Dynamic strength, Wear tooth load, Design procedure of Worm gear.

**Design Data Books** (permitted for reference in the university examination)

1. Mahadevan, K., and K. Balaveera Reddy, *Design Data Handbook*, Mechanical Engineers in SI and Metric Units. CBS Publishers & Distributors, New Delhi, 2018.
2. NarayanaIyengar B.R &Lingaiah K, *Machine Design Data Handbook*, Tata McGraw Hill/Suma Publications, 1984
3. PSG Design Data, DPV Printers, Coimbatore, 2012

**Reference Books**

1. J. E. Shigley, *Mechanical Engineering Design*, McGraw Hill, 2003
2. Jalaludeen, *Machine Design*, Anuradha Publications, 2016
3. V.B.Bhandari, *Design of Machine elements*, McGraw Hill, 2016
4. Juvinall R.C & Marshek K.M., *Fundamentals of Machine Component Design*, John Wiley, 2011
5. M. F. Spotts, T. E. Shoup, *Design of Machine Elements*, Pearson Education, 2006
6. RajendraKarwa, *Machine Design*, Laxmi Publications (P) LTD, New Delhi, 2006
7. Siegel, Maleev & Hartman, *Mechanical Design of Machines*, International Book Company, 1983

**Course Contents and Lecture Schedule**

Module	Topic	No. of Lectures
1.1	Shafting: - material, design considerations, causes of failure in shafts, design based on strength, rigidity, and critical speed, design for static and fatigue loads, repeated loading, reversed bending.	5
1.2	Design of flat belt:- material for belts, slip of the belts, creep, centrifugal tension, Power transmitted by flat belts, Design procedure of flat belts	3
1.3	Design of connecting rod in IC engine.	2
2.1	Design of clutches:-single and multiple plate clutch, cone clutch, centrifugal clutch	2
2.2	Design of brakes:-band brakes, block brakes, simple and differential band brake, internal expanding shoe brake.	3
3.1	Sliding contact bearing:- lubrication, lubricants, viscosity, journal bearings, hydrodynamic theory, Petroff's equation, bearing characteristic number, Sommerfeld number, Heat generated in bearings, Heat dissipated by bearings, Design procedure of Journal bearings.	4
3.2	Ball and roller bearings:- Types, bearing life, static and dynamic load capacity, Stribeck's Equation, selection of bearings, selection of taper roller bearings, Design procedure of Ball and	3

	roller bearings, Needle bearings.	
4.1	Gears:- Materials of gears, terminology of spur Gear, Interference and undercutting, Gear tooth failures, Beam strength of Gear tooth, Estimation of module, Buckingham's equation for dynamic load, wear load, endurance strength of tooth, Gear proportions, Merits and demerits of each type of gears, Design procedure of Spur gear.	5
4.2	Helical gears:- Terminology, Virtual or equivalent number of teeth, Tooth proportions, Beam strength, and Wear strength of Helical gears, Design procedure of Helical gear	3
5.1	Bevel gears:- Classification, Terminology, Pitch angle for bevel gears, Strength of bevel gear, beam strength, wear tooth load, Formative number of teeth, Design procedure of Bevel gear.	3
5.2	Worm gears:- Characteristics of worm gears, Terminology, Advantages and disadvantages, Applications, Terms in Worm gear, Strength of Worm gear, Dynamic strength, Wear tooth load, Design procedure of Worm gear.	2

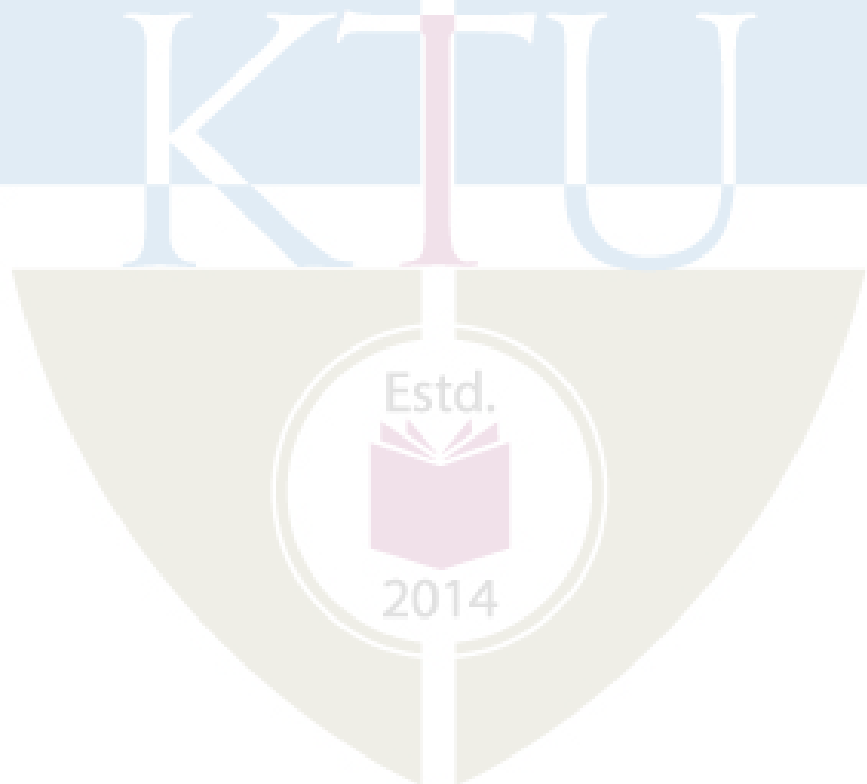

CODE	COURSE NAME	CATEGORY	L	T	P	CREDIT
MEL411	MECHANICAL ENGINEERING LAB	PCC	0	0	3	2

**Preamble:** The course is intended to enable the students to get an exposure to equipment and exercises related to machine dynamics, cutting forces in milling machine, basics of pneumatic and hydraulic devices, basic concepts of stepper motors, basic ideas of data acquisition systems and automation.

**Prerequisite:** Should have undergone courses on Engineering Mechanics, Theory of Machines, Machine Tools.

**Course Outcomes:** After completion of the course the student will be able to

<b>CO 1</b>	Get practical knowledge on design and analysis of mechanisms in the machines.
<b>CO 2</b>	Measure the cutting forces associated with milling machining operations.
<b>CO 3</b>	Apply the basic concepts of hydraulic and pneumatic actuators and their applications in product and processes
<b>CO 4</b>	Use appropriate systems for data acquisition and control of product and processes

#### Mapping of course outcomes with program outcomes

	PO 1	PO 2	PO 3	PO 4	PO 5	PO 6	PO 7	PO 8	PO 9	PO 10	PO 11	PO 12
<b>CO 1</b>	3	2	2	3	3		2		3	2		2
<b>CO 2</b>	3	2	2	3	3		2		3	2		2
<b>CO 3</b>	3	2	2	3	3		2		3	2		2
<b>CO 4</b>	3	2	2	3	3		2		3	2		2

#### Assessment Pattern

#### Mark distribution

Total Marks	CIE	ESE	ESE Duration
150	75	75	2.5 hours

**Continuous Internal Evaluation Pattern:**

Attendance	:	15 marks
Continuous Assessment	:	30 marks
Internal Test (Immediately before the second series test)	:	30 marks

**End Semester Examination Pattern:** The following guidelines should be followed regarding award of marks

(a) Preliminary work	:	15 Marks
(b) Implementing the work/Conducting the experiment	:	10 Marks
(c) Performance, result and inference (usage of equipments and trouble shooting)	:	25 Marks
(d) Viva voce	:	20 marks
(e) Record	:	5 Marks

**General instructions:** Practical examination to be conducted immediately after the second series test covering entire syllabus given below. Evaluation is a serious process that is to be conducted under the equal responsibility of both the internal and external examiners. The number of candidates evaluated per day should not exceed 20. Students shall be allowed for the University examination only on submitting the duly certified record. The external examiner shall endorse the record.

**List of Exercises/Experiments:** (Lab experiments may be given considering 12 sessions of 3 hours each. Minimum 10 experiments to be performed.)

1. Experiment on Whirling of shaft
2. Experiment on Gyroscope
3. Experiment on Universal governor apparatus
4. Experiment on Free vibration analysis
5. Experiment on Forced vibration analysis
6. Experiment on any Non destructive test.
7. Exercises on Milling Machine - slab milling/gear cutting
8. Milling forces – Milling parameters – measurement of milling forces in slab milling operations
9. Exercises on pneumatic circuits using pneumatic trainer unit
10. Exercises on hydraulic circuits using hydraulic trainer unit
11. Exercises on electro pneumatic and electro hydraulic circuits using trainer units
12. Exercises on 3-D printing
13. Exercises on Motion controller using AC/DC motor, servo motors and encoders to determine the operating characteristics.
14. Exercises on stepper motor to determine the operating characteristics.
15. Exercises on PC based data acquisition system with any software.
16. Study of SCADA and PLC programming
17. Interfacing SCADA with PLC and PC.
18. Controlling variable speed drive through PLC/SCADA

**Reference Books**

1. C.E.Wilson, P. Sadler, Kinematics and Dynamics of Machinery, Pearson Education, 2005
2. D.H.Myskza, Machines and Mechanisms Applied Kinematic Analysis, Pearson Education, 2013
3. W.Bolton, Mechatronics: Electronic Control Systems in Mechanical and Electrical Engineering, Person Education Limited, New Delhi, 2007
4. K.P.Ramachandran, G.K.Vijayaraghavan, M.S.Balasundaram, Mechatronics: Integrated Mechanical Electronic Systems, Wiley India Pvt. Ltd., New Delhi, 2008.
5. Serope Kalpakjian, Steven R. Schmid - Manufacturing Engineering and Technology, Pearson



MEQ413	SEMINAR	CATEGORY	L	T	P	CREDIT
		PWS	0	0	3	2

**Preamble:** The course ‘Seminar’ is intended to enable a B.Tech graduate to read, understand, present and prepare report about an academic document. The learner shall search in the literature including peer reviewed journals, conference, books, project reports etc., and identify an appropriate paper/thesis/report in her/his area of interest, in consultation with her/his seminar guide. This course can help the learner to experience how a presentation can be made about a selected academic document and also empower her/him to prepare a technical report.

**Course Objectives:**

- To do literature survey in a selected area of study.
- To understand an academic document from the literature and to give a presentation about it.
- To prepare a technical report.

**Course Outcomes [COs] :** After successful completion of the course, the students will be able to:

CO1	Identify academic documents from the literature which are related to her/his areas of interest (Cognitive knowledge level: <b>Apply</b> ).
CO2	Read and apprehend an academic document from the literature which is related to her/ his areas of interest (Cognitive knowledge level: <b>Analyze</b> ).
CO3	Prepare a presentation about an academic document (Cognitive knowledge level: <b>Create</b> ).
CO4	Give a presentation about an academic document (Cognitive knowledge level: <b>Apply</b> ).
CO5	Prepare a technical report (Cognitive knowledge level: <b>Create</b> ).

**Mapping of course outcomes with program outcomes:**

	PO1	PO2	PO3	PO4	PO5	PO6	PO7	PO8	PO9	PO10	PO11	PO12
<b>CO1</b>	2	2	1	1		2	1					3
<b>CO2</b>	3	3	2	3		2	1					3
<b>CO3</b>	3	2			3			1		2		3
<b>CO4</b>	3				2			1		3		3
<b>CO5</b>	3	3	3	3	2	2		2		3		3

**Abstract POs defined by National Board of Accreditation**

<b>PO#</b>	<b>Broad PO</b>	<b>PO#</b>	<b>Broad PO</b>
PO1	Engineering Knowledge	PO7	Environment and Sustainability
PO2	Problem Analysis	PO8	Ethics
PO3	Design/Development of solutions	PO9	Individual and team work
PO4	Conduct investigations of complex problems	PO10	Communication
PO5	Modern tool usage	PO11	Project Management and Finance
PO6	The Engineer and Society	PO12	Life long learning

### General Guidelines

- The Department shall form an Internal Evaluation Committee (IEC) for the seminar with academic coordinator for that program as the Chairperson/Chairman and seminar coordinator & seminar guide as members. During the seminar presentation of a student, all members of IEC shall be present.
- Formation of IEC and guide allotment shall be completed within a week after the University examination (or last working day) of the previous semester.
- Guide shall provide required input to their students regarding the selection of topic/paper.
- Choosing a seminar topic: The topic for a UG seminar should be current and broad based rather than a very specific research work. It's advisable to choose a topic for the Seminar to be closely linked to the final year project area. Every member of the project team could choose or be assigned Seminar topics that covers various aspects linked to the Project area.
- A topic/paper relevant to the discipline shall be selected by the student during the semester break.
- Topic/Paper shall be finalized in the first week of the semester and shall be submitted to the IEC.
- The IEC shall approve the selected topic/paper by the second week of the semester.
- Accurate references from genuine peer reviewed published material to be given in the report and to be verified.

**Evaluation pattern**

**Total marks: 100, only CIE, minimum required to pass 50**

**Seminar Guide:** 20 marks (Background Knowledge – 10 (The guide shall give deserving marks for a candidate based on the candidate's background knowledge about the topic selected), Relevance of the paper/topic selected – 10).

**Seminar Coordinator:** 20 marks (Seminar Diary – 10 (Each student shall maintain a seminar diary and the guide shall monitor the progress of the seminar work on a weekly basis and shall approve the entries in the seminar diary during the weekly meeting with the student), Attendance – 10).

**Presentation:** 40 marks to be awarded by the IEC (Clarity of presentation – 10, Interactions – 10 (to be based on the candidate's ability to answer questions during the interactive session of her/his presentation), Overall participation – 10 (to be given based on her/his involvement during interactive sessions of presentations by other students), Quality of the slides – 10).

**Report:** 20 marks to be awarded by the IEC (check for technical content, overall quality, templates followed, adequacy of references etc.).



MED415	PROJECT PHASE I	CATEGORY	L	T	P	CREDIT
		PWS	0	0	6	2

**Preamble:** The course ‘Project Work’ is mainly intended to evoke the innovation and invention skills in a student. The course will provide an opportunity to synthesize and apply the knowledge and analytical skills learned, to be developed as a prototype or simulation. The project extends to 2 semesters and will be evaluated in the 7<sup>th</sup> and 8<sup>th</sup> semester separately, based on the achieved objectives. One third of the project credits shall be completed in 7<sup>th</sup> semester and two third in 8<sup>th</sup> semester. It is recommended that the projects may be finalized in the thrust areas of the respective engineering stream or as interdisciplinary projects. Importance should be given to address societal problems and developing indigenous technologies.

### Course Objectives

- To apply engineering knowledge in practical problem solving.
- To foster innovation in design of products, processes or systems.
- To develop creative thinking in finding viable solutions to engineering problems.

**Course Outcomes [COs] :**After successful completion of the course, the students will be able to:

CO1	Model and solve real world problems by applying knowledge across domains (Cognitive knowledge level: <b>Apply</b> ).
CO2	Develop products, processes or technologies for sustainable and socially relevant applications (Cognitive knowledge level: <b>Apply</b> ).
CO3	Function effectively as an individual and as a leader in diverse teams and to comprehend and execute designated tasks (Cognitive knowledge level: <b>Apply</b> ).
CO4	Plan and execute tasks utilizing available resources within timelines, following ethical and professional norms (Cognitive knowledge level: <b>Apply</b> ).
CO5	Identify technology/research gaps and propose innovative/creative solutions (Cognitive knowledge level: <b>Analyze</b> ).
CO6	Organize and communicate technical and scientific findings effectively in written and oral forms (Cognitive knowledge level: <b>Apply</b> ).

### Mapping of course outcomes with program outcomes

	PO1	PO2	PO3	PO4	PO5	PO6	PO7	PO8	PO9	PO10	PO11	PO12
<b>CO1</b>	2	2	2	1	2	2	2	1	1	1	1	2
<b>CO2</b>	2	2	2		1	3	3	1	1		1	1
<b>CO3</b>									3	2	2	1
<b>CO4</b>					2			3	2	2	3	2
<b>CO5</b>	2	3	3	1	2							1
<b>CO6</b>					2			2	2	3	1	1

MECHANICAL ENGINEERING			
Abstract POs defined by National Board of Accreditation			
PO#	Broad PO	PO#	Broad PO
PO1	Engineering Knowledge	PO7	Environment and Sustainability
PO2	Problem Analysis	PO8	Ethics
PO3	Design/Development of solutions	PO9	Individual and team work
PO4	Conduct investigations of complex problems	PO10	Communication
PO5	Modern tool usage	PO11	Project Management and Finance
PO6	The Engineer and Society	PO12	Lifelong learning

### PROJECT PHASE I

#### Phase 1 Target

- Literature study/survey of published literature on the assigned topic
- Formulation of objectives
- Formulation of hypothesis/ design/ methodology
- Formulation of work plan and task allocation.
- Block level design documentation
- Seeking project funds from various agencies
- Preliminary Analysis/Modeling/Simulation/Experiment/Design/Feasibility study
- Preparation of Phase 1 report

#### Evaluation Guidelines & Rubrics

Total: 100 marks (Minimum required to pass: 50 marks).

- Project progress evaluation by guide: 30 Marks.
- Interim evaluation by the Evaluation Committee: 20 Marks.
- Final Evaluation by the Evaluation Committee: 30 Marks.
- Project Phase - I Report (By Evaluation Committee): 20 Marks.

(The evaluation committee comprises HoD or a senior faculty member, Project coordinator and project supervisor).

## Evaluation by the Guide

The guide/supervisor shall monitor the progress being carried out by the project groups on a regular basis. In case it is found that progress is unsatisfactory it shall be reported to the Department Evaluation Committee for necessary action. The presence of each student in the group and their involvement in all stages of execution of the project shall be ensured by the guide. Project evaluation by the guide: 30 Marks. This mark shall be awarded to the students in his/her group by considering the following aspects:

**Topic Selection:** innovativeness, social relevance etc. (2)

**Problem definition:** Identification of the social, environmental and ethical issues of the project problem. (2)

**Purpose and need of the project:** Detailed and extensive explanation of the purpose and need of the project. (3)

**Project Objectives:** All objectives of the proposed work are well defined; Steps to be followed to solve the defined problem are clearly specified. (2)

**Project Scheduling & Distribution of Work among Team members:** Detailed and extensive Scheduling with timelines provided for each phase of project. Work breakdown structure well defined. (3)

**Literature survey:** Outstanding investigation in all aspects. (4)

**Student's Diary/ Daily Log:** The main purpose of writing daily diary is to cultivate the habit of documenting and to encourage the students to search for details. It develops the students' thought process and reasoning abilities. The students should record in the daily/weekly activity diary the day to day account of the observations, impressions, information gathered and suggestions given, if any. It should contain the sketches & drawings related to the observations made by the students. The daily/weekly activity diary shall be signed after every day/week by the guide. (7)

**Individual Contribution:** The contribution of each student at various stages. (7)

**EVALUATION RUBRICS for PROJECT Phase I: Interim Evaluation**

No.	Parameters	Marks	Poor	Fair	Very Good	Outstanding
1-a	Topic identification, selection, formulation of objectives and/or literature survey. (Group assessment) [CO1]	10	The team has failed to come with a relevant topic in time. Needed full assistance to find a topic from the guide. They do not respond to suggestions from the evaluation committee and/or the guide. No literature review was conducted. The team tried to gather easy information without verifying the authenticity. No objectives formed yet.	The team has identified a topic. The originally selected topic lacks substance and needs to be revised. There were suggestions given to improve the relevance and quality of the project topic. Only a few relevant references were consulted/ studied and there is no clear evidence to show the team's understanding on the same. Some objectives identified, but not clear enough.	Good evidence of the group thinking and brainstorming on what they are going to build. The results of the brainstorming are documented and the selection of topic is relevant. The review of related references was good, but there is scope of improvement. Objectives formed with good clarity, however some objectives are not realistic enough.	The group has brainstormed in an excellent manner on what they were going to build. The topic selected is highly relevant, real world problem and is potentially innovative. The group shows extreme interest in the topic and has conducted extensive literature survey in connection with the topic. The team has come up with clear objectives which are feasible.
			(0 – 3 Marks)	(4 – 6 Marks)	(7 - 9 Marks)	(10 Marks)
1-b	Project Planning, Scheduling and Resource/ Tasks Identification and allocation. (Group assessment) [CO4]	10	No evidence of planning or scheduling of the project. The students did not plan what they were going to build or plan on what materials / resources to use in the project. The students do not have any idea on the budget required. The team has not yet decided on who does what. No project journal kept.	Some evidence of a primary plan. There were some ideas on the materials /resources required, but not really thought out. The students have some idea on the finances required, but they have not formalized a budget plan. Schedules were not prepared. The project journal has no details. Some evidence on task allocation among the team members.	Good evidence of planning done. Materials were listed and thought out, but the plan wasn't quite complete. Schedules were prepared, but not detailed, and needs improvement. Project journal is presented but it is not complete in all respect / detailed. There is better task allocation and individual members understand about their tasks. There is room for improvement.	Excellent evidence of enterprising and extensive project planning. Gantt charts were used to depict detailed project scheduling. A project management/version control tool is used to track the project, which shows familiarity with modern tools. All materials / resources were identified and listed and anticipation of procuring time is done. Detailed budgeting is done. All tasks were identified and incorporated in the schedule. A well-kept project journal shows evidence for all the above, in addition to the interaction with the project guide. Each member knows well about their individual tasks.
			(0 – 3 Marks)	(4 – 6 Marks)	(7 - 9 Marks)	(10 Marks)
<b>Phase 1 Interim Evaluation Total Marks: 20</b>						

**EVALUATION RUBRICS for PROJECT Phase I: Final Evaluation**

Sl. No.	Parameters	Marks	Poor	Fair	Very Good	Outstanding
1-c	Formulation of Design and/or Methodology and Progress. (Group assessment) [CO1]	5	None of the team members show any evidence of knowledge about the design and the methodology adopted till now/ to be adopted in the later stages. The team has not progressed from the previous stage of evaluation.	The students have some knowledge on the design procedure to be adopted, and the methodologies. However, the team has not made much progress in the design, and yet to catch up with the project plan.	The students are comfortable with design methods adopted, and they have made some progress as per the plan. The methodologies are understood to a large extent.	Shows clear evidence of having a well- defined design methodology and adherence to it. Excellent knowledge in design procedure and its adaptation. Adherence to project plan is commendable.
			(0 – 1 Marks)	(2 – 3 Marks)	(4 Marks)	(5 Marks)
1-d	Individual and Teamwork Leadership ( Individual assessment) [CO3]	10	The student does not show any interest in the project activities, and is a passive member.	The student show some interest and participates in some of the activities. However, the activities are mostly easy and superficial in nature.	The student shows very good interest in project, and takes up tasks and attempts to complete them. Shows excellent responsibility and team skills. Supports the other members well.	The student takes a leadership position and supports the other team members and leads the project. Shows clear evidence of leadership.
			(0 – 3 Marks)	(4 – 6 Marks)	(7 - 9 Marks)	(10 Marks)
1-e	Preliminary Analysis/ Modeling / Simulation/ Experiment / Design/ Feasibility study [CO1]	10	The team has not done any preliminary work with respect to the analysis/modeling/ simulation/experiment/design/feasibility study/ algorithm development.	The team has started doing some preliminary work with respect to the project. The students however are not prepared enough for the work and they need to improve a lot.	There is some evidence to show that the team has done good amount of preliminary investigation and design/ analysis/ modeling etc. They can improve further.	Strong evidence for excellent progress in the project. The team has completed the required preliminary work already and are poised to finish the phase I in an excellent manner. They have shown results to prove their progress.
			(0 – 3 Marks)	(4 – 6 Marks)	(7 - 9 Marks)	(10 Marks)

1-f	Documentation and presentation. (Individual & group assessment).  [CO6]	5	<p>The team did not document the work at all. The project journal/diary is not presented. The presentation was shallow in content and dull in appearance. The individual student has no idea on the presentation of his/her part.</p>	<p>Some documentation is done, but not extensive. Interaction with the guide is minimal. Presentation include some points of interest, but overall quality needs to be improved. Individual performance to be improved.</p>	<p>Most of the project details were documented well enough. There is scope for improvement. The presentation is satisfactory. Individual performance is good.</p>	<p>The project stages are extensively documented in the report. Professional documentation tools like LaTeX were used to document the progress of the project along with the project journal. The documentation structure is well-planned and can easily grow into the project report.</p> <p>The presentation is done professionally and with great clarity. The individual's performance is excellent.</p>
			(0 – 1 Marks)	(2 – 3 Marks)	(4 Marks)	(5 Marks)
<b>Total</b>		<b>30</b>	<b>Phase - I Final Evaluation Marks: 30</b>			



**EVALUATION RUBRICS for PROJECT Phase I: Report Evaluation**

<b>Sl. No.</b>	<b>Parameters</b>	<b>Marks</b>	<b>Poor</b>	<b>Fair</b>	<b>Very Good</b>	<b>Outstanding</b>
1-g	Report [CO6]	20	The prepared report is shallow and not as per standard format. It does not follow proper organization. Contains mostly Unacknowledged content. Lack of effort in preparation is evident.	Project report follows the standard format to some extent. However, its organization is not very good. Language needs to be improved. All references are not cited properly in the report.	Project report shows evidence of systematic documentation. Report is following the standard format and there are only a few issues. Organization of the report is good. Most of references are cited properly.	The report is exceptionally good. Neatly organized. All references cited properly. Diagrams/Figures, Tables and equations are properly numbered, and listed and clearly shown. Language is excellent and follows standard styles.
			(0 - 7 Marks)	(8 - 12 Marks)	(13 - 19 Marks)	(20 Marks)
<b>Phase - I Project Report Marks: 20</b>						

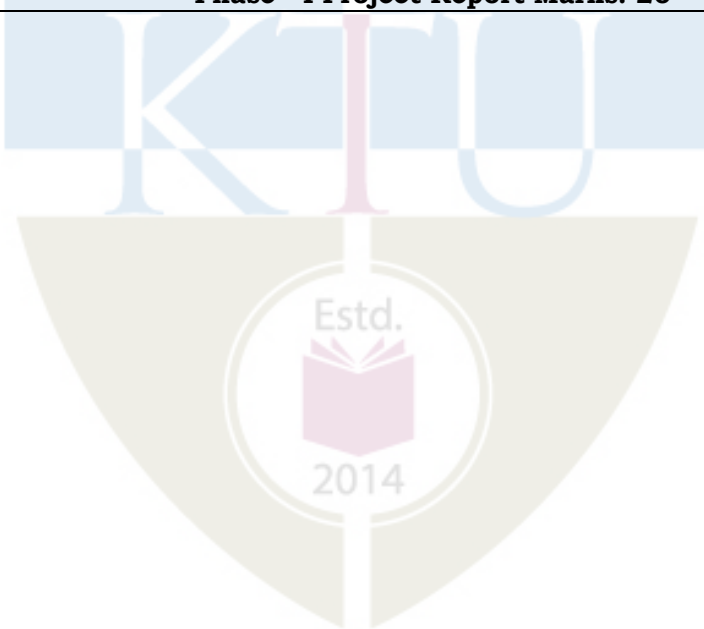

APJ ABDUL KALAM  
TECHNOLOGICAL  
UNIVERSITY

**SEMESTER VII**  
**PROGRAM ELECTIVE II**



CODE	COURSE NAME	CATEGORY	L	T	P	CREDIT
MET413	ADVANCED METHODS IN NON DESTRUCTIVE TESTING	PEC	2	1	0	3

**Preamble:**

1. To develop a fundamental knowledge about the advanced techniques and the recent developments in non-destructive testing so as to control the quality in manufacturing engineering components
2. To gain practical knowledge in non-destructive testing (NDT) processes and provide a detailed discussion on the advanced non destructive testing methods
3. To equip them with the knowledge of different NDT methods in complex geometries and enable them to select the appropriate methods for better evaluation.
4. To gain advanced knowledge of ultrasonic testing and X- ray radiography which enables them to perform inspection of samples.
- 5 To equip them with the knowledge of different NDT methods so as to control the quality in manufacturing of engineering components.

**Prerequisite:** NIL

**Course Outcomes:** After the completion of the course the student will be able to

CO 1	Understand the theoretical and practical knowledge in methods of non-destructive testing processes
CO 2	Understand the knowledge of advanced methods in ultrasonic testing which enables them to perform inspection of samples.
CO 3	Illustrate complete theoretical and practical understanding of the radiographic testing, interpretation and evaluation.
CO 4	Understand the recent advances in the field of non-destructive testing
CO 5	Outline the recent and advanced developments in radiography testing

**Mapping of course outcomes with program outcomes**

	PO 1	PO 2	PO 3	PO 4	PO 5	PO 6	PO 7	PO 8	PO 9	PO 10	PO 11	PO 12
CO 1	3		3			2	2	1	2			1
CO 2	3		3			2	2	1	2			1
CO 3	3		3			2	2	1	2			1
CO 4	3		3			2	2	1	2			1
CO 5	3		3			2	2	1	2			1

**Assessment Pattern**

Bloom's Category	Continuous Assessment Tests		End Semester Examination
	1	2	
Remember	10	10	10
Understand	20	20	20
Apply	10	10	50
Analyse	10	10	20
Evaluate			
Create			

**Mark distribution**

Total Marks	CIE	ESE	ESE Duration
150	50	100	3 hours

**Continuous Internal Evaluation Pattern:**

Attendance	10 marks
Continuous Assessment Test (2 numbers)	25 marks
Assignment/Quiz/Course project	15 marks

**End Semester Examination Pattern:** There will be two parts; Part A and Part B. Part A contain 10 questions with 2 questions from each module, having 3 marks for each question. Students should answer all questions. Part B contains 2 questions from each module of which student should answer any one. Each question can have maximum 2 sub-divisions and carry 14 marks.

**Course Level Assessment Questions****Course Outcome 1 (CO1):**

- 1.How visual inspection helps in non-destructive testing?
- 2.What is the use of field indicators in MPI?
- 3.What are the different types of developers ?Describe the properties of good liquid penetrant.
- 4.What are the applications of eddy current testing?

**Course Outcome 2 (CO2):**

1. Describe the method of generating ultrasonic waves.
2. Explain the features of ultrasonic guided waves.
3. Describe the features of electromagnetic acoustic transducer .
4. Describe a method of detecting kissing bonds in friction stir welds of aero structures.

**Course Outcome 3 (CO3):**

1. Explain the radiography testing using Cobalt 60 isotopes.
2. Describe image quality indicators in Radiography testing.
3. Explain the principle of radiation.
4. How the quality of a good radiograph is assessed.

**Course Outcome 4 (CO4):**

1. Illustrate the procedure of phased array inspection.
2. Describe the techniques of Time of flight diffraction.
3. Explain the methods of structural health monitoring.
4. Explain the use of Synthetic aperture focussing technique.

**Course Outcome 5 (CO5):**

1. Describe a technique for inspecting and monitoring the behaviour of equipment and materials performing under stress.
2. Suggest a suitable inspection method for detecting potential problems in energised electrical components.
3. Explain the advantages of digital radiography in medical application compared to conventional x-ray film radiography.
4. Describe the applications of Computed Tomography in industry.

**Model Question paper**

Reg No.: _____		Name: _____	
<b>APJ ABDUL KALAM TECHNOLOGICAL UNIVERSITY</b>			
<b>Course Code: MET 413</b>			
<b>Course Name: Advanced methods in Non Destructive Testing</b>			
Max. Marks: 100		Duration: 3 Hours	
<b>PART A</b>			
<i>(Answer all questions; each question carries 3 marks)</i>			Marks
1		Explain any three Visual aids used in visual inspection.	3
2		Describe the principle of liquid penetrant inspection.	3
3		What is Snell's law of critical angle?	3
4		What is laser shearography?	3
5		What is radiographic sensitivity?	3
6		What are the properties of X-rays?	3
7		What is neutron radiography?	3
8		Explain the concept of structural health monitoring.	3
9		Differentiate between digital radiography and computed tomography.	3
10		Describe the applications of thermography testing.	3
<b>PART B</b>			
<i>(Answer one full question from each module, each question carries 14 marks)</i>			
<b>Module -1</b>			
11	a)	With a simple sketch, explain any two magnetisation techniques used in magnetic particle inspection.	8
	b)	Explain the procedure of magnetic particle inspection of casting.	6

12	a)	With sketches, explain eddy current inspection process.	8
	b)	Explain various methods of liquid penetrant inspection.	6
<b>Module -2</b>			
13	a)	Explain the methods of generating ultrasonic waves.	8
	b)	Describe the features of Electro Magnetic Acoustic Transducer.	6
14	a)	Explain the concept of laser ultrasonics.	8
	b)	Explain various modes of display in ultrasonic testing.	6
<b>Module -3</b>			
15	a)	What are the safety measures to be followed in radiography testing?	8
	b)	What is sensitometry? Discuss the importance of characteristics curves.	6
16	a)	What is Real time radiography? Explain its advantages.	8
	b)	Explain the procedure of film processing in radiography testing.	6
<b>Module -4</b>			
17	a)	Explain the principle of phased array techniques.	8
	b)	Describe the theory of time of flight diffraction (TOFD).	6
18	a)	Explain the features of Flash radiography for material motion detection.	8
	b)	What are the applications of thermography testing?	6
<b>Module -5</b>			
19	a)	Explain the principle of acoustic emission inspection.	8
	b)	Explain any four types of leak testing..	6
20	a)	Describe two methods of thermography testing.	8
	b)	Explain the industrial applications of computed tomography.	6

## Syllabus

### Module 1

Visual Testing -Liquid Penetrant Testing-Magnetic Particle Testing- Magnetic Particle Testing Equipment- Eddy Current Testing – Selection of testing methods- Codes, Standards and Specifications.

### Module 2

Fundamentals of Ultrasonic Waves-- Snell's law and critical angles – Fresnel and Fraunhofer effects– wave propagation in other engineering materials. Generation of ultrasonic waves– contact testing, immersion testing. Ultrasonic Guided Waves- Basics of guided waves– Generation of guided waves–Introduction to Electro –Magnetic Acoustic Transducer(EMAT -Optical methods in Ultrasonics- Laser Ultrasonics –optical detection of ultrasound – measurement of in plane displacement and velocity – Laser shearography – Applications

### Module 3

Basic Principles of Radiography -Film Radiography -Radiographic Image Quality and Radiographic Techniques -Radiation Detectors and Safety - Principle of radiation- Special Radiographic Techniques and Interpretation of radiographs of Fluoroscopy-Real-time radiology – Principle of neutron radiography - – Principle and application of in-motion and flash radiography- Interpretation of radiographs:- Interpretation for welds, castings etc, applications, various case studies, Inspection standards - applicable codes, standards and specifications (ASME, ASTM, AWS, BS, IBR etc.)

### Module 4

Phased Array Techniques- Principles of phased array inspection – phased array probes and their characteristics – Phased array wedges – Focal law– Beam shaping, steering –Scanning with phased array probes- linear, sectorial, C scan. Time of Flight Diffraction Theory and principles of Time of Flight Diffraction (TOFD)–Data acquisition and interpretation– TOFD techniques – selection of probe angle– calibration and optimization, optimizing angles– flaw location and sizing– codes and standards–interpretation, evaluation, applications. Introduction to Synthetic Aperture Focusing Technique (SAFT). Structural Health Monitoring (SHM)-methods- strain gauging- genetic algorithm

### Module 5

Acoustic emission inspection-Leak Testing - -Thermographic NDE- Contact and non contact thermal inspection methods– Heat sensitive paints – Heat sensitive papers -Inspection methods – Infrared radiation and infrared detectors–thermo mechanical behavior of materials– IR imaging in aerospace applications-Digital Radiography and Computed Tomography (CT) -computed radiography(CR) and direct radiography (DR) -industrial CT.

**Text Books**

1. J.Prasad and C. G. K. Nair, Non-Destructive Test and Evaluation of Materials, Tata McGraw-Hill Education, 2nd edition (2011).
- 2.. B.Raj, T. Jayakumar and M. Thavasimuthu, Practical Non Destructive Testing, Alpha Science International Limited, 3rd edition (2007).
3. J. L. Rose, Ultrasonic waves in solid media, Cambridge University Press, (2004).
4. A.S. Paipetis, T. E Matikas and D. G. Aggelis, Emerging Technologies in Non-Destructive Testing, CRC Press, (2012).

**Reference Books**

1. X. P. V. Maldague, Nondestructive evaluation of materials by infrared thermography, Springer-Verlag, 1st edition, (1993)
2. Non-Destructive Examination and Quality Control, ASM International, Vol.17, 9th edition (1989)
3. J. Krautkramer and H. Krautkramer, Ultrasonic Testing of Materials, Springer, 4th edition (1990).
- 4.L. W. Schmerr, Fundamentals of Ultrasonic Phased Arrays, Springer, (2014)

**Course Contents and Lecture Schedule**

No	Topic	No. of Lectures
1.1	<b>Visual Testing</b> Fundamentals of Visual Testing – vision, lighting, material attributes, environmental factors, visual perception, direct and indirect methods <b>Liquid Penetrant Testing</b> Principles – types and properties of liquid penetrants – developers – advantages and limitations of various methods - selection of penetrant method - Applicable codes and standards	3
1.2	<b>Magnetic Particle Testing</b> Theory of magnetism – ferromagnetic, paramagnetic materials – characteristics of magnetic fields	2
1.3	<b>Magnetic Particle Testing Equipment</b> Selecting the method of magnetization, inspection materials, magnetic particle inspection of castings and welding – Dry continuous method, wet residual method- Applicable codes and standards	2
1.4	<b>Eddy Current Testing</b> Generation of eddy currents – effect of change of impedance on instrumentation – properties of eddy currents – eddy current sensing elements, probes, type of coil arrangement Applicable codes and standards.	2
2.1	<b>Fundamentals of Ultrasonic Waves</b> Nature of sound waves, wave propagation in metals– modes of sound wave generation – longitudinal waves, transverse waves, surface waves, lamb waves– Snell’s law and critical angles – Fresnel and Fraunhofer effects– wave propagation in other engineering materials.	2

2.2	<b>Generation of ultrasonic waves</b> Methods of ultrasonic wave generation – piezo electric effect, piezo electric materials and their properties – crystal cuts and mode of vibration – Ultrasonic search Units (transducers), types (straight, angle, dual)	2
2.3	<b>Ultrasonic Inspection Methods and Equipment</b> Principle of pulse echo method, through transmission method, resonance method – Advantages, limitations – contact testing, immersion testing.	2
2.4	<b>Ultrasonic Guided Waves-</b> Basics of guided waves– Generation of guided waves–Introduction to Electro –Magnetic Acoustic Transducer -EMAT Optical methods in Ultrasonics- Laser Ultrasonics –bulk wave and lamb wave generation mechanisms – optical detection of ultrasound – measurement of in plane displacement and velocity – Laser shearography – Applications	3
3.1	<b>Basic Principles of Radiography</b> - Radio isotopic sources X-ray source generation and properties – industrial X-ray tubes <b>Film Radiography</b> -X-ray film – structure and types for industrial radiography – sensitometric properties – use of film, characteristic curves (H & D curve).	2
3.2	<b>Radiographic Image Quality and Radiographic Techniques</b> Radiographic sensitivity –single and double wall Radiography – panoramic radiography-procedure shooting sketch/technique sheets	3
3.3	<b>Radiation Detectors and Safety</b> Special and SI Units of radiation – Principle of radiation	2
4.1	<b>Special Radiographic Techniques and Interpretation of radiographs</b> Principles and applications of Fluoroscopy/Real-time radioscopy – advantages and limitations –recent advances, intensifier tubes, vidicon tubes etc– Principle of neutron radiography - attenuation of neutrons - direct and indirect technique - advantages and limitations – Principle and application of in-motion and flash radiography. <i>Interpretation of radiographs:-</i> Interpretation for welds, castings etc, applications, various case studies, Inspection standards - applicable codes, standards and specifications (ASME, ASTM, AWS, BS, IBR etc.	3
4.2	<b>Phased Array Techniques</b> Principles of phased array inspection – phased array probes and their characteristics – Phased array wedges – Focal law– Beam shaping, steering –Scanning with phased array probes- linear, sectorial, C scan.	2
4.3	<b>Time of Flight Diffraction</b> Theory and principles of Time of Flight Diffraction (TOFD)–Data acquisition and interpretation–	2

	TOFD techniques – selection of probe angle– calibration and optimization, optimizing angles– flaw location and sizing– codes and standards–interpretation, evaluation, applications	
4.4	<i>Introduction to Synthetic Aperture Focusing Technique (SAFT).</i> <b>Structural Health Monitoring (SHM)</b> -methods- strain gauging- genetic algorithm-	2
5.1	<b>Acoustic emission inspection</b> Principles and Theory – Signal Propagation – Physical Considerations – The AE Process Chain - Time Considerations – AE Parameters –AE testing during grinding – pipelines – steam turbines – AE location of faults in power transformers. .	2
5.2	<b>Leak Testing</b> Introduction to leak testing– objectives – terminologies – measurement of leakage –Types of leak – Types of flow in leaks – Principles of Fluid dynamics – Leak Testing of Pressure Systems Without and with a Tracer Gas – Halogen diode leak testing – Helium mass spectrometer leak testing and subsystems –Leak testing for special applications-standards.	2
5.3	<b>Thermographic NDE</b> Introduction and fundamentals to infrared and thermal testing– Heat transfer – Active and passive techniques – Lock in and pulse thermography– Contact and non contact thermal inspection methods– Heat sensitive paints – Heat sensitive papers – thermally quenched phosphors liquid crystals -Inspection methods – Infrared radiation and infrared detectors–thermo mechanical behavior of materials	3
5.4	<b>Digital Radiography and Computed Tomography (CT)</b> Principles of Digital Radiography-Methods of digital radiography – digitization of X-ray films – computed radiography(CR) and direct radiography (DR) – process of image formation in CR – comparison of film, CR and DR method. Computed Tomography – industrial CT.	2

Estd.



2014

CODE	COURSE NAME	CATEGORY	L	T	P	CREDIT
MET423	OPTIMIZATION TECHNIQUES AND APPLICATIONS	PEC	2	1	0	3

**Preamble:** This course introduces the students to the concept of solving engineering problems by developing linear and non-linear mathematical models. The models involve objectives and constraints in terms of the relevant design variables. The student learns to apply a suitable mathematical programming technique to solve the developed model. The course includes Linear Programming, Integer Programming, Dynamic Programming, Classical Optimization and Metaheuristic techniques.

**Prerequisite:** Basic concepts of linear algebra.

**Course Outcomes:** After the completion of the course the student will be able to

CO 1	Formulate engineering problems as mathematical programming problems.
CO 2	Apply Simplex and dual Simplex methods to solve linear programming problems.
CO 3	Analyse the sensitivity of the model parameters
CO 4	Solve integer programming problems.
CO 5	Apply Dynamic Programming techniques to solve sequential optimization problems
CO 6	Apply classical optimization techniques and algorithms to solve nonlinear optimization problems.

#### Mapping of course outcomes with program outcomes

	PO 1	PO 2	PO 3	PO 4	PO 5	PO 6	PO 7	PO 8	PO 9	PO 10	PO 11	PO 12
CO 1	3	3	3	3	1							
CO 2	3	3	2	2	2							
CO 3	3	3	3	3	2							
CO 4	3	3	2	2	2							
CO 5	3	3	2	2								
CO 6	3	3	3	3								

#### Assessment Pattern

Bloom's Category	Continuous Assessment Tests		End Semester Examination
	1	2	
Remember			5
Understand			5
Apply	30	30	40
Analyse	10	10	20
Evaluate	10	10	20
Create			10

**Mark distribution**

<b>Total Marks</b>	<b>CIE</b>	<b>ESE</b>	<b>ESE Duration</b>
150	50	100	3 hours

**Continuous Internal Evaluation Pattern:**

Attendance	: 10 marks
Continuous Assessment Test (2 numbers)	: 25 marks
Assignment/Quiz/Course project	: 15 marks

**End Semester Examination Pattern:** There will be two parts; Part A and Part B. Part A contain 10 questions with 2 questions from each module, having 3 marks for each question. Students should answer all questions. Part B contains 2 questions from each module of which student should answer any one. Each question can have maximum 2 sub-divisions and carry 14 marks.

**Course Level Assessment Questions****Course Outcome 1 (CO1):**

1. Consider a chocolate manufacturing company that produces only two types of chocolate – A and B. Both the chocolates require Milk and Choco only. Each unit of A requires 1 unit of Milk and 3 units of Choco, and each unit of B requires 1 unit of Milk and 2 units of Choco. The company kitchen has a total of 5 units of Milk and 12 units of Choco. On each sale, the company makes a profit of Rs 6 per unit A sold, and Rs 5 per unit B sold. Now, the company wishes to maximize its profit. Formulate the problem as a LPP and determine how many units of A and B should it produce respectively?
2. A person wishes to invest Rs.14,000. He has identified four investment opportunities. Investment 1 requires an investment of \$5,000 and has a present value (a time-discounted value) of \$8,000; Investment 2 requires \$7,000 and has a value of \$11,000; Investment 3 requires \$4,000 and has a value of \$6,000; and Investment 4 requires \$3,000 and has a value of \$4,000. Into which investments should he place his money so as to maximize the total present value?
3. Find the dimensions of a box of largest volume that can be inscribed in a sphere of unit radius.

**Course Outcome 2 (CO2)**

1. Solve the following LPP using simplex method.

$$\text{Minimize } Z = 4x_1 + x_2$$

Subject to:

$$3x_1 + x_2 = 3;$$

$$4x_1 + 3x_2 \geq 6;$$

$$x_1 + 2x_2 \leq 4;$$

$$x_1, x_2 \geq 0;$$

2. Show that the Big-M method will conclude that the following LPP has no feasible solution.

$$\text{Maximize } Z = 2x_1 + 5x_2$$

Subject to:

$$3x_1 + 2x_2 \geq 6;$$

$$2x_1 + x_2 \leq 2;$$

$$x_1, x_2 \geq 0;$$

3. Generate the dual simplex iterations for the LPP given below and find the solution.

$$\text{Minimize } Z = 5x_1 + 6x_2$$

Subject to :

$$x_1 + x_2 \geq 2;$$

$$4x_1 + x_2 \geq 4;$$

$$x_1, x_2 \geq 0;$$

### Course Outcome 3(CO3):

1. The following LPP has an optimal solution of  $x_1 = 320$ ;  $x_2 = 360$  and Objective function value = 4360.

$$\text{Maximize } Z = 8x_1 + 5x_2$$

Subject to:

$$2x_1 + 1x_2 \leq 1000;$$

$$3x_1 + 4x_2 \leq 2400;$$

$$x_1 + x_2 \leq 700;$$

$$x_1 - x_2 \leq 350;$$

$$x_1, x_2 \geq 0.$$

Carry out sensitivity analysis to determine the range in which the objective function coefficients can vary keeping the current solution as optimal.

2. Determine the shadow price corresponding to the first constraint for the LPP given in the previous question.
3. Describe the concept of shadow price and reduced cost.

### Course Outcome 4 (CO4):

1. Solve the following integer programming problem using Branch and Bound algorithm.

$$\text{Maximize } Z = 5x_1 + 4x_2;$$

Subject to:

$$x_1 + x_2 \leq 5;$$

$$10x_1 + 6x_2 \leq 45;$$

$$x_1, x_2 \geq 0, \text{ and integers.}$$

2. Solve the following integer programming problem using the cutting plane algorithm.

$$\text{Maximize } Z = 7x_1 + 10x_2$$

Subject to:

$$-x_1 + 3x_2 \leq 6;$$

$$7x_1 + x_2 \leq 35;$$

$$x_1, x_2 \geq 0, \text{ and integers.}$$

3. Solve the following integer programming problem.

$$\text{Maximize } Z = 2x_1 + 3x_2$$

Subject to:

$$5x_1 + 7x_2 \leq 35;$$

$$4x_1 + 9x_2 \leq 36;$$

$$x_1, x_2 \geq 0, \text{ and integers.}$$

### Course Outcome 5 (CO5):

1. Find the shortest distance between the origin and destination for the network given below using dynamic programming.

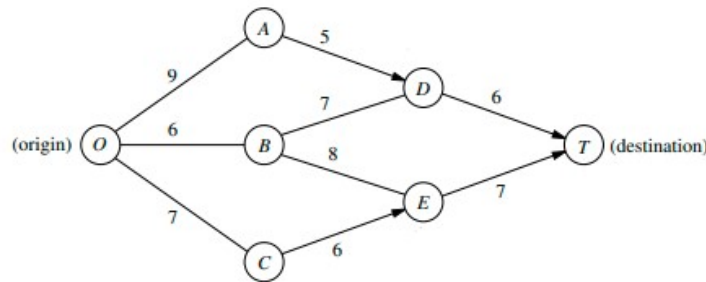

2. What is Bellman's principle of optimality?

3. A college student has 7 days remaining before the final examinations for four courses, and she wants to allocate this study time as effectively as possible. She needs at least 1 day on each course, and likes to concentrate on just one course each day. So she wants to allocate 1, 2, 3, or 4 days to each course. She decides to use dynamic programming to make these allocations to maximize the total grade points to be obtained from the four courses. She estimates that the alternative allocations for each course would yield the number of grade points shown in the table given below. Solve this problem using dynamic programming.

Study Days	Estimated grade points			
	Course 1	Course 2	Course 3	Course 4
1	3	5	2	6
2	5	5	4	7
3	6	6	7	9
4	7	9	8	9

### Course Outcome 6 (CO6):

1. Maximize the function  $f(x_1, x_2, x_3) = x_1 + 2x_2 + x_2x_3 - x_1^2 - x_2^2 - x_3^2$

2. Find the solution for the following problem using the Lagrange multiplier method.

$$\text{Minimize } f(x, y) = 5x^{-1}y^{-2}$$

$$\text{subject to : } g(x, y) = x^2 + y^2 - 9 = 0$$

3. Use the Fibonacci search method to minimize the function

**Model Question Paper**

**APJ ABDUL KALAM TECHNOLOGICAL UNIVERSITY**  
**VII SEMESTER BTECH DEGREE EXAMINATION**  
**MET423: OPTIMIZATION TECHNIQUES AND APPLICATIONS**

Maximum : 100 Marks

Duration : 3 hrs.

**PART A**

*Answer all questions. Each question carries 3 marks.*

1. How is degeneracy identified in the simplex procedure?
2. What is the role of artificial variables in simplex method?
3. Write the dual for the following LPP.

Maximize  $Z = 5x_1 + 4x_2$ ;

Subject to:

$$x_1 + x_2 \leq 5;$$

$$10x_1 + 6x_2 \leq 45;$$

$$x_1, x_2 \geq 0.$$

4. What is meant by shadow price?
5. Explain the importance of integer programming models and their applications.
6. What is Bellman's principle of optimality?
7. Find the extreme points of the function

$$f(x) = 12x^5 - 45x^4 + 40x^3 + 5$$

8. State the necessary and sufficient conditions for the maximum of a multivariable function  $f(X)$ .
9. Find the Hessian matrix of the function  $f(x) = 3x_1^2x_2^2 - x_2^2x_3^3$
10. Describe the procedure of Golden Section search method.

**PART B**

*Answer one full question from each module*

**Module 1**

11. a) Consider a chocolate manufacturing company that produces only two types of chocolate – A and B. Both the chocolates require Milk and Choco only. Each unit of A requires 1 unit of Milk and 3 units of Choco, and each unit of B requires 1 unit of Milk and 2 units of Choco. The company kitchen has a total of 5 units of Milk and 12 units of Choco. On each sale, the company makes a profit of Rs 6 per unit A sold, and Rs 5 per unit B sold. Now, the company wishes to maximize its profit. Formulate the problem as a

LPP and graphically determine how many units of A and B should it produce respectively?

(5 Marks)

b) Use Simplex method to solve the following LPP.

$$\text{Minimize } Z = 4x_1 + x_2$$

Subject to:

$$3x_1 + x_2 = 3;$$

$$4x_1 + 3x_2 \geq 6;$$

$$x_1 + 2x_2 \leq 4;$$

$$x_1, x_2 \geq 0;$$

(9 Marks)

12. Solve the following LPP using Simplex method and carry out sensitivity analysis to determine the range in which the objective function coefficients can vary keeping the current solution as optimal.

$$\text{Maximize } Z = 8x_1 + 5x_2$$

Subject to:

$$2x_1 + 1x_2 \leq 1000;$$

$$3x_1 + 4x_2 \leq 2400;$$

$$x_1 + x_2 \leq 700;$$

$$x_1 - x_2 \leq 350;$$

$$x_1, x_2 \geq 0.$$

(14 Marks)

### Module 2

13. Generate the dual simplex iterations for the LPP given below and find the solution.

$$\text{Minimize } Z = 5x_1 + 6x_2$$

Subject to :

$$x_1 + x_2 \geq 2;$$

$$4x_1 + x_2 \geq 4;$$

$$x_1, x_2 \geq 0;$$

(14 Marks)

14. Solve the following integer programming problem using Branch and Bound algorithm.

$$\text{Maximize } Z = 2x_1 + 3x_2$$

Subject to:

$$5x_1 + 7x_2 \leq 35;$$

$$4x_1 + 9x_2 \leq 36;$$

$$x_1, x_2 \geq 0, \text{ and integers}$$

(14 Marks)

## Module 3

15. Find the shortest distance between the origin and destination for the network given below using dynamic programming.

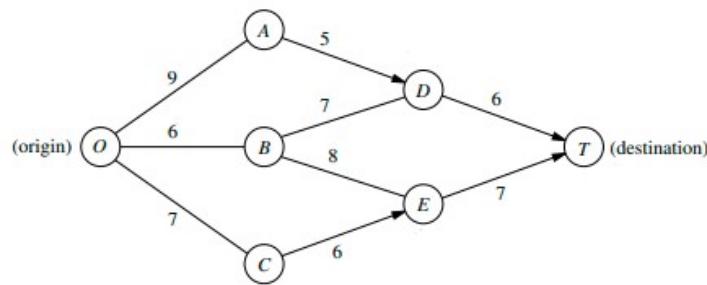

(14 Marks)

16. A candidate in an election wants to purchase TV time for a total of four commercials on TV stations located in four areas. Based on polling information, an estimate is made of the number of votes that can be won in the different areas depending upon the number of commercials run. These estimates are given in the table in thousands of votes. Use dynamic programming to find how the four commercials should be distributed among the four areas to maximize the estimated number of votes won.

Commercials	Area			
	1	2	3	4
0	0	0	0	0
1	4	6	5	3
2	7	8	9	7
3	9	10	10	12
4	12	11	12	14

(14 Marks)

## Module 4

17. a) Find the extreme points of the function  $f(X) = x_1^3 + x_2^3 + 2x_1^2 + 4x_2^2 + 6$

(6 Marks)

- b) Find the maximum of the function  $f(X) = 2x_1 + x_2 + 10$ ; subject to  $g(X) = x_1 + 2x_2^2 = 3$  using the Lagrange multiplier method.

(8 Marks)

18. a) Find the dimensions of a box of largest volume that can be inscribed in a sphere of unit radius.

(6 Marks)

- b) Maximize the function  $f(x_1, x_2, x_3) = x_1 + 2x_2 + x_2x_3 - x_1^2 - x_2^2 - x_3^2$

(8 Marks)

**Module 5**

19. a) Minimize the function  $f(x) = 0.65 - [0.75/(1+x^2)] - 0.65x \tan^{-1}(1/x)$  in the interval  $[0,3]$  using the Fibonacci method with  $n = 6$ . (7 Marks)
- b) Use the steepest descent method to search for the minimum for the function  $f(x, y) = 25x^2 + y^2$ . Start at  $(1, 3)$  with a step size of 0.5 (7 Marks)
20. a) Use the golden section search method to minimize the function  $f(x) = x^4 - 14x^3 + 60x^2 - 70x$  in the range  $[0,2]$ . (7 Marks)
- b) Solve  $\cos x = 2x$  using Newton Raphson method. Carry out 4 iterations. (7 Marks)

**Syllabus****Module 1**

Formulation of engineering problems as mathematical programming models: Linear Programming formulations.

Solutions to Linear Programming Problems: Simplex method – Big-M and 2-phase methods – Sensitivity Analysis for the objective function coefficients and right hand side coefficients of constraints - Exceptional cases in LPP.

**Module 2**

Duality concept in LPP - Dual Simplex method.

Integer Programming problem: Applications of Integer Programming problems - Integer Programming algorithms - Cutting Plane method - Branch and Bound method.

**Module 3**

Dynamic Programming: Bellman's principle of optimality - Forward recursion and backward recursion - Application problems- Shortest route and Knapsack problems.

**Module 4**

Classical optimization techniques: Single variable optimization - Multivariable optimization with no constraints - Optimization with equality constraints - Method of Lagrange Multipliers - Optimization with inequality constraints - Kuhn-Tucker conditions.

**Module 5**

Algorithms for unconstrained optimization: Fibonacci search method - Golden section search method -Hooke and Jeeve's method - Newton-Raphson method - Cauchy's (Steepest descent) method.

**Text Books**

1. Hamdy A. Taha, “Operations Research, An Introduction”, Pearson Education, 10<sup>th</sup> edition, 2019.
2. S. S. Rao, “Engineering Optimization, Theory and Practice”, New Age International, 3<sup>rd</sup> edition, 2013

**Reference Books**

1. N. V. S. Raju, “ Optimization Methods for Engineers”, Prentice-Hall of India, 1<sup>st</sup> edition, 2014
2. Ravindran, Philips and Solberg, “Operations Research, Principles and Practice”, Wiley, 2<sup>nd</sup> edition, 2007

**Course Contents and Lecture Schedule**

No	Topic	No. of Lectures
1	<b>Module 1</b>	
1.1	Formulation of engineering problems as mathematical programming models.	1
1.2	Linear Programming models, Examples	1
1.3	Graphical method to solve LPP	1
1.4	Simplex method, Introduction	1
1.5	Example problems using Simplex method	2
1.6	Big-M method and 2-phase method	2
1.7	Sensitivity analysis	2
1.8	Exceptional cases	1
2	<b>Module 2</b>	
2.1	Duality concept in LPP	1
2.2	Dual Simplex method	2
2.3	Integer Programming problem – Introduction and applications.	1
2.4	Branch and Bound method	2
2.5	Cutting Plane method	2
3	<b>Module 3</b>	
3.1	Dynamic Programming- Introduction and Bellman’s principle of optimality	1
3.2	Forward recursion and backward recursion	1
3.3	Application problems -Shortest route problem	2
3.4	Knapsack problem	2
4	<b>Module 4</b>	
4.1	Classical optimization – Introduction- Single variable optimization	1
4.2	Multivariable optimization with no constraints	2
4.3	Optimization with equality constraints - Method of Lagrange	2

	Multipliers	
4.4	Optimization with inequality constraints - Kuhn-Tucker conditions.	2
5	<b>Module 5</b>	
5.1	Algorithms for unconstrained optimization- Introduction	1
5.2	Fibonacci search method	1
5.3	Golden section search method	1
5.4	Hooke and Jeeve's method	1
5.5	Newton-Raphson method.	1
5.6	Cauchy's (Steepest descent) method	1





**Assessment Pattern**

Bloom's Category	Continuous Assessment Tests		End Semester Examination
	1	2	
Remember			
Understand	10	10	30
Apply	40	40	70
Analyse			
Evaluate			
Create			

**Mark distribution**

Total Marks	CIE	ESE	ESE Duration
150	50	100	3 hours

**Continuous Internal Evaluation Pattern:**

Attendance	: 10 marks
Continuous Assessment Test (2 numbers)	: 25 marks
Assignment/Quiz/Course project	: 15 marks

**End Semester Examination Pattern:** There will be two parts; Part A and Part B. Part A contain 10 questions with 2 questions from each module, having 3 marks for each question. Students should answer all questions. Part B contains 2 questions from each module of which student should answer any one. Each question can have maximum 2 sub-divisions and carry 14 marks.

**Course Level Assessment Questions:****Course Outcome 1 (CO1):**

1. List various computational schemes involving Matrix methods for solution of boundary value problems.
2. List the mathematical strategies for converting (partial) differential equations into matrix equations.
3. Apply the direct method of FEM formulation to introduce Matrix methods in one-dimensional problems.
4. Apply the Principle of Total Potential energy to formulate FEM equations for 1-D spring element.

**Course Outcome 2 (CO2)**

1. Formulate the rotation matrix for coordinate transformation between local and global coordinates.
2. Assembly and solution for truss analysis.
3. Formulate stiffness matrix for beam problem.
4. Solution of beam problems using FEM.

**Course Outcome 3(CO3):**

1. Review of the constitutive matrix  $[D]$  for Plane-stress and Plane-strain cases.
2. Derivation of two-dimensional FEM equations for stress-analysis, using the Total Potential energy approach.
3. Formulate shape functions for some two dimensional elements.
4. Formulate strain-displacement gradient matrix  $[B]$  for the 3node triangular element (CST) and four node rectangular elements.
5. Assembly, application of boundary conditions and solution of problems involving CST.

**Course Outcome 4 (CO4):**

1. Demonstrate the motivation for Coordinate transformation using natural coordinates for formulations involving higher order elements.
2. Deduction of shape functions in terms of natural coordinates using Serendipity and Lagrange's Interpolation methods.
3. Perform Isoparametric formulation to derive stiffness matrix for (i) the general four node Quadrilateral element and (ii) eight node Quadrilateral element.
4. Perform Numerical integration in two-dimensions using Gauss Quadrature.
5. Illustration of solution of a structural problem for nodal unknowns, employing the above features (isoparametric formulation and Gaussian integration).

**Course Outcome 5 (CO5):**

1. Apply Galerkin's technique for FEM formulation.
2. Solve 1-D heat transfer problems employing FEM.
3. Formulate vibration problems using FEM
4. Solve Natural frequency (single degree of freedom, undamped) problems using FEM
5. Discuss practical aspects of FEM modelling.

**Model Question Paper****MODEL QUESTION PAPER APJ ABDUL KALAM TECHNOLOGICAL  
UNIVERSITY****SEVENTH SEMESTER B.TECH DEGREE EXAMINATION****Course Code : MET433****Course Name : FINITE ELEMENT METHOD****Max. Marks : 100****Duration : 3 Hours****PART – A****(ANSWER ALL QUESTIONS, EACH QUESTION CARRIES 3 MARKS)**

1. Compare and contrast FEM, FDM and FVM
2. Comment on the sources of errors in a FEM solution
3. What are local and global coordinates? How are they connected in a planar truss problem?
4. Explain the *Fixed end reactions method* in solving beam problems.
5. Make a short note on the Total potential energy method of formulating a FEM problem.
6. What are degrees of freedom in the context of an FEM element for structural analysis?
7. What is the motivation for coordinate transformation employing natural coordinates?
8. Evaluate the following integral using two-point Gauss Quadrature. Sampling points are at  $\pm 1/\sqrt{3}$ , and both weights are equal to unity.

$$\int_{-1}^1 (x^2 + 2x + 2) dx$$

9. How is the natural frequency of a system related to the eigen-value ?
10. Comment on the convergence of a static-structural FE simulation run.

**PART – B****(ANSWER ONE FULL QUESTION FROM EACH MODULE)****MODULE – 1**

11. For the assembly shown, formulate the global stiffness matrix, and equations (in matrix form) for the solution of the unknown global displacements and forces.  $P= 2\text{kN}$ ,  $k_1=1000\text{ kN/m}$ ,  $k_2=k_3=500\text{ kN/m}$ . (14 Marks)

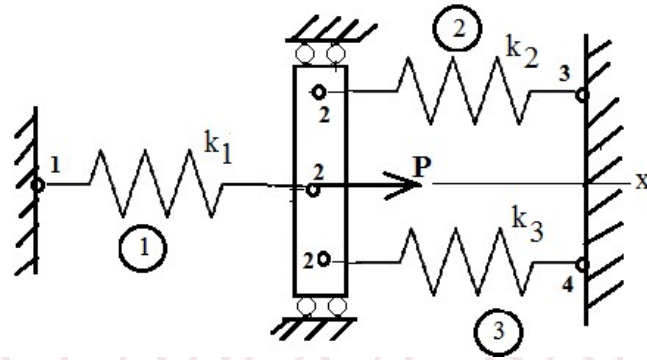

OR

12. Using Total Potential Energy Principle, derive the global stiffness matrix for the following assemblage of spring elements in series applied by a force ( $P$ ) applied at node-4, along the  $x$ -axis. Subsequently, using the numerical values provided, find displacements at nodes 2 and 4, reaction forces at nodes 1 and 2, the force in each spring.  $P=450\text{ N}$ ,  $k_1=10,000\text{ N/m}$ ,  $k_2=20,000\text{ N/m}$ ,  $k_3=10,000\text{ N/m}$ . (14 Marks)

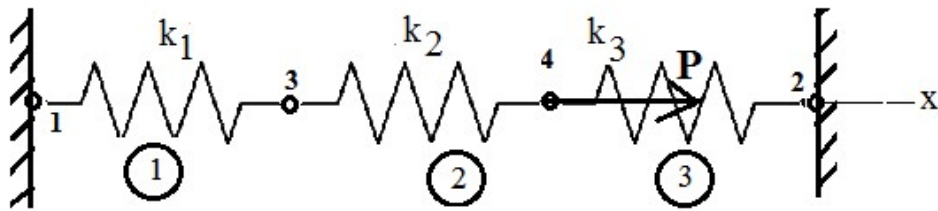

## MODULE - 2

13. (a) Derive the stiffness matrix for an element for a planar truss problem in terms of the components of the rotation (transformation) matrix. (6 Marks)
- (b) Determine the nodal displacements and rotations and the global and element forces for the beam supported and loaded as shown.  $E = 210\text{ GPa}$ , Moment of inertia of cross-section,  $I = 2 \times 10^{-4}\text{ m}^4$ , and spring stiffness =  $200\text{ kN/m}$ . (8 Marks)

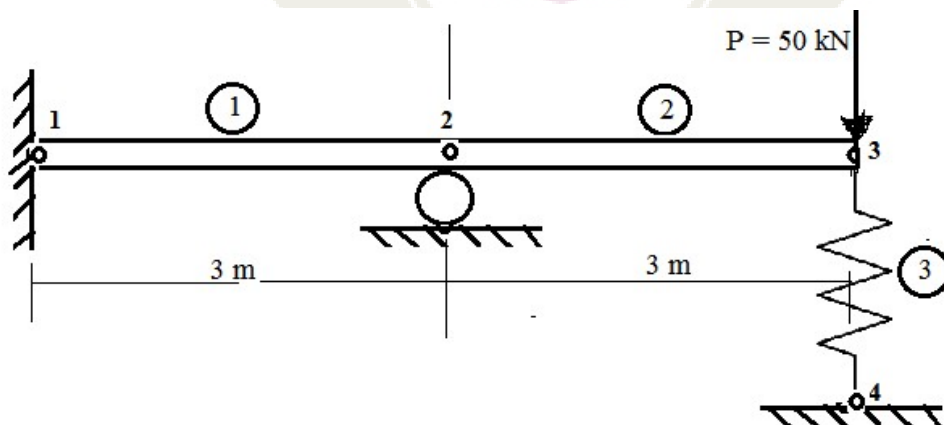

OR

14. (a) Derive the stiffness matrix for FEM analysis used to analyse beam problems based on Euler-Bernoulli theory. (5 Marks)

(b) Find stresses in the truss (rod) elements, if both rods have  $E = 210 \text{ GPa}$ , and area of cross section  $5.0 \times 10^{-2} \text{ m}^2$  (9 Marks)

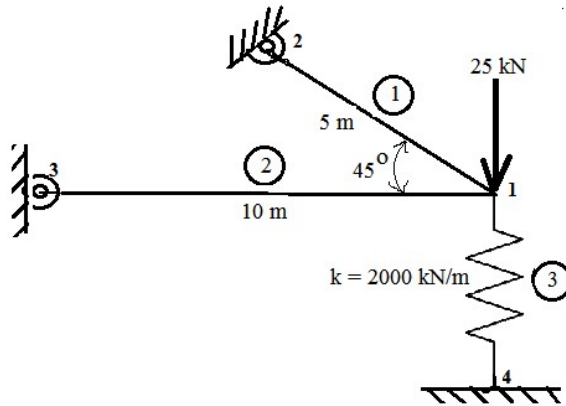

## MODULE – 3

15. (a) Values for the field variable at the nodes (coordinates as indicated) of a triangular element are as shown. Assign appropriate node numbers and evaluate shape functions and calculate the value of the field variable at the coordinates (5,7). (9 Marks)

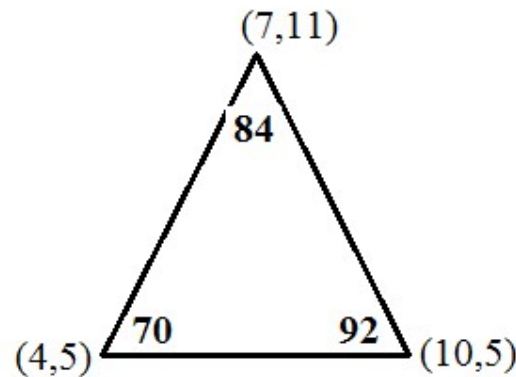

(b) For a 2D stress analysis problem employing a three noded triangular element, with vertices at (0,1), (0,-1) and (2,0), evaluate the Strain-Displacement Matrix. (5 Marks)

OR

16. (a) A thin plate as shown is pulled by a uniform load as shown. Should it be treated as a plane-stress problem or Plane strain problem? Justify. Accordingly, for the two-element

discretization shown, evaluate the Strain-Displacement Matrices and the Constitutive matrix.  
 $E = 200 \text{ GPa}$ , Poissons ration is  $0.3$  and thickness  $t = 10 \text{ mm}$ . (9 Marks)

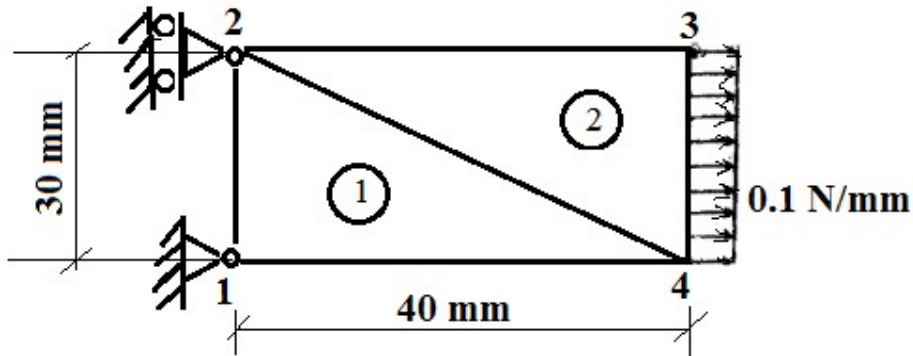

(b) What are the unknown variables at each node and the boundary conditions? How will you determine the stiffness matrix (need not compute the stiffness matrix)? Give the Load vector. (5 Marks)

#### MODULE – 4

17. (a) For a 4 node quadrilateral element for two dimensional stress analysis, derive expression for the Jacobian Matrix connecting the derivatives in  $(X, Y)$  and  $(\xi, \eta)$  coordinates (8 Marks)

(b) If the nodes of a quadrilateral with coordinates  $(x_1, y_1)$ ,  $(x_2, y_2)$ ,  $(x_3, y_3)$ ,  $(x_4, y_4)$ , are  $(20, 20)$ ,  $(40, 30)$ ,  $(50, 50)$  and  $(15, 40)$ , evaluate the Jacobian at  $\xi = 0.5$ ,  $\eta = 0.5$  (6 Marks)

OR

18. A bilinear rectangular element is loaded as shown. If the Jacobian at  $\xi = 1/3$ ,  $\eta = 1/3$  is given by  $\begin{bmatrix} 2 & 0 \\ 0 & 1.5 \end{bmatrix}$ , evaluate the corresponding B Matrix. (10 Marks)

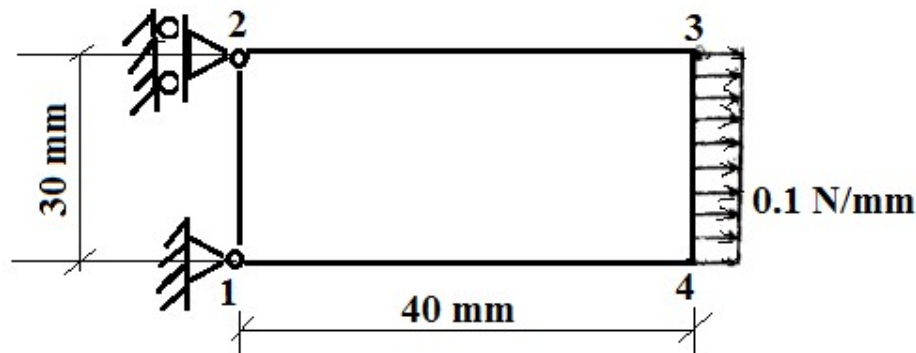

(b) What are the boundary conditions for this problem if the displacements at each node 'i' are represented as  $u_i$  and  $v_i$ . (1 Mark)

(c) If the problem is solved and displacements obtained, how can the strains be determined? And also, stresses? (solutions not intended) (3 Marks)

## MODULE – 5

19. (a) Using the Galerkin's Weak formulation, derive the finite element equations for a one-dimensional steady state heat conduction problem with constant thermal conductivity and no heat generation. (8 marks)

(b) A heat transfer fin of radius 1 cm and length 5 cm is attached to a boiler-wall maintained at  $140^{\circ}\text{C}$  and the other end is exposed to atmosphere. Find the temperature (at steady state) of the tip exposed to atmosphere and also at a point at 0.5 cm from the free end, by employing a two-element finite elements assembly. The curved surface of the fin is well insulated.  $T = 40^{\circ}\text{C}$ ,  $h = 10 \text{ W/cm}^2\text{C}$ .  $K = 70 \text{ W/cm}^{\circ}\text{C}$ . (6 marks)

OR

20. Derive the finite element equations for free vibration analysis due to axial displacements of rod elements using Galerkin's technique (8 marks)

(b) Determine the first two natural frequencies of longitudinal vibrations of the stepped steel bar shown. All dimensions are in mm.  $E = 200 \text{ GPa}$ ,  $\rho = 7800 \text{ N/m}^3$ , length  $L = 500 \text{ mm}$ . (6 marks)

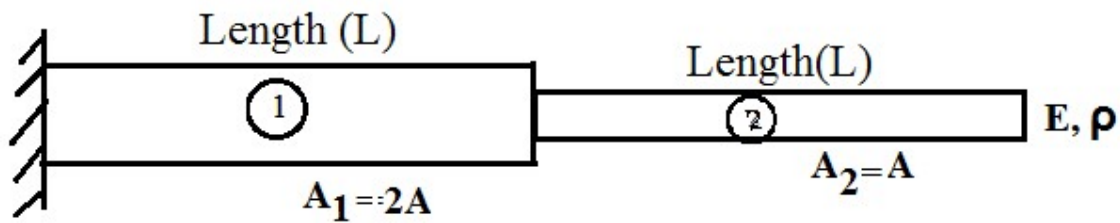

## Syllabus

## Module 1 (9 Hours)

FEM as a numerical computational tool in Computer Aided Design & Analysis- general features of numerical solutions-general strategy of Matrix Methods in Computational Mechanics- overview of similar numerical methods (FDM, FEM, FVM, BEM)-overview of general formulation methods leading to Matrix equations (Stiffness (direct) method, Potential energy method, Galerkin's etc.) - commercial and free FEM packages.

Direct approach of formulating the FEM equations for 1D stress problems:- element stiffness – assembly of elements – properties of  $[K]$  matrix – treatment of boundary conditions- stress computation – support reaction – simple problems.

Application of the Principle of Total Potential energy to formulate FEM equations for 1-D spring element. Simple problems involving assemblage of spring elements.

**Module 2 (8 Hours)**

Plane truss element formulation – coordinate transformation – local and global coordinates – element matrices – assembly of elements – treatment of boundary conditions – stress calculation – Planar truss problems .

Beam element: Beam relationships – 1-D beam element FE formulation - element stiffness matrix – load considerations – boundary conditions – solution of problems.

**Module 3 (8 Hours)**

Review of Constitutive Matrix [D] for Plane-stress and Plane-strain formulations- derivation of two-dimensional FEM equations for stress-analysis, using the Total Potential energy approach- Shape functions, equations for displacement field in terms of nodal displacements for (i) the 3-noded triangular element (CST) and (ii) four-node-rectangular elements. Strain-displacement gradient matrix [B] for the above elements- numerical problems involving 3-node-triangular elements.

**Module 4 (9 Hours)**

Motivation for Coordinate transformation using natural coordinates, deduction of shape functions in terms of natural coordinates: Serendipity and Lagrange's Interpolation methods- Isoparametric formulation for (i) the general four- node- Quadrilateral element and (ii) eight-node- Quadrilateral element (curved boundaries)- Gauss Quadrature in 2-dimensions- Illustrative examples.

**Module 5 (7Hours)**

Strong and Weak form , Galerkin's weighted residual FEM formulation ; One dimensional axially loaded bar, heat flow in a bar- numerical problems.

FEM formulation for (undamped) Natural frequency estimation in 1-D structural problems – simple examples.

Practical considerations in FEM analysis: aspect ratio and element types, use of symmetry in analysis, natural subdivisions at discontinuities, h and p methods of refinement, handling concentrated point loads and infinite stress in some geometries (re-entrant corners)-treatment of infinite medium, connecting different types of elements. Convergence of solution (demonstration of the above aspects in a FEM software environment recommended).

**Text Books**

1. Daryl L. Logan, "A First Course in the Finite Element Method", Cengage Learning India Pvt. Ltd., 5<sup>th</sup> edition, 2012.
2. . Seshu P., "Textbook of Finite Element Analysis", PHI Learning Private Ltd., Ninth printing, 2010.

## Reference Books

1. Robert D Cook, David S Malkus, Michael E. Plesha and Robert J. Witt , “Concepts And Applications of Finite Element Analysis”, Wiley Student Edition, 4<sup>th</sup> Edition, 2007.
2. J. N. Reddy, “An Introduction to the Finite Element Method”, McGraw Hill International 4<sup>th</sup> Edition, 2018.
- 3.S. S. Rao, “The Finite Element Method in Engineering”, Butterworth-Heinemann Ltd; 3rd Revised edition, 1999.
- 4.K. J. Bathe, “Finite Element Procedures in Engineering Analysis”, Prentice Hall, Pearson Education Inc., 2<sup>nd</sup> edition, 2014.
- 5.O. C. Zienkiewics, R. L. Taylor, “The Finite Element Method,” Vol I & II, John Wiley & Sons Inc. 5th edition, 2000.

## Course Contents and Lecture Schedule

No	Topic	No. of Lectures
1	<b>Module-1 ( 8 Hours)</b>	
1.1	FEM as a numerical tool - general features of numerical solutions-general strategy of Matrix Methods.	1 Hour
1.2	Overview of FDM, FEM, FVM, BEM-overview of general formulation methods leading to Matrix equations.	1 Hour
1.3	Direct approach of formulating the FEM equations for 1D stressl problems:- element stiffness – assembly of elements – properties of [K] matrix – treatment of boundary conditions- stress computation – support reaction	2 Hours
1.4	Application of the Principle of Total Potential energy to formulate FEM equations for 1-D spring element.	1 Hour
1.5	Numerical Problems on direct method and Potential Energy Principle	3 Hours
2	<b>Module-2 (6 Hours)</b>	
2.1	Truss element formulation – coordinate transformation – local and global coordinates – element matrices	1 Hour
2.2	Assembly of elements – treatment of boundary conditions – stress calculation –Planar truss problems .	1 Hour
2.3	Tutorial on truss problems	1 Hour
2.4	1-D beam element FE formulation - element stiffness matrix –	1 Hour
2.5	Load considerations – boundary conditions for Beams	1 Hour
2.6	Tutorial on Beam problems	1 Hour
3	<b>Module-3 (7 Hours)</b>	
3.1	derivation of two-dimensional FEM equations for stress-analysis, using the Total Potential energy approach.	2 Hours
3.2	Shape functions, equations for displacement field in terms of nodal displacements for (i) the three-node-triangular element (CST) and (ii) four-node-rectangular elements.	2 Hours

3.3	Strain-displacement gradient matrix [B] for the above elements-	1 Hour
3.4	Tutorial Problems involving 3-node-triangular elements.	2 Hours
4	<b>Module-4 (8 Hours)</b>	
4.1	Coordinate transformation using natural coordinates, of shape functions in terms of natural coordinates: Serendipity and Lagrange's Interpolation methods.	2 Hours
4.2	- Isoparametric formulation for (i) the general four- node- Quadrilateral element and	2 Hours
4.3	Isoparametric formulation for (i) the general four- node- Quadrilateral element and (ii) eight-nod- Quadrilateral element (curved boundaries)	2 Hours
4.4	Gauss Quadrature in 2-dimensions- Illustrative examples.	1 Hour
4.5	Tutorial Problems involving isoparametric formulation.	1 Hour
5	<b>Module-5 (7 Hours)</b>	
5.1	Strong and weak form of simple problem	1 Hour
5.2	Galerkin's formulation of one dimensional axially loaded bar	1 Hours
5.3	Galerkin's formulation of one dimensional Heat flow in a bar	1 Hours
5.4	FEM formulation for (undamped) Natural frequency estimation in	1 Hour
5.5	Tutorial problems on 1-D problem	1 Hour
5.6	Practical considerations in FEM analysis and demonstration of these aspects in a FEM software environment.	2 Hours



CODE	COURSE NAME	CATEGORY	L	T	P	CREDIT
MET443	AEROSPACE ENGINEERING	PEC	2	1	0	3

**Preamble :** This course provides fundamentals of aerospace engineering and understanding of flight instruments. To educate students the fundamental aerospace disciplines necessary to carry out the design of an aerospace vehicle or systems.

**Prerequisite :** Nil

**Course Outcomes:** After completion of the course the student will be able to

CO1	Explain the characteristics of atmosphere
CO2	Discuss airfoil theory, 2D, 3D or Finite aero foils
CO3	Explain perform analysis of flight dynamics of aircrafts
CO4	Understand different flight instruments
CO5	Discuss the principles of wind tunnel testing

**Mapping of course outcomes with program outcomes**

	PO 1	PO 2	PO 3	PO 4	PO 5	PO 6	PO 7	PO 8	PO 9	PO 10	PO 11	PO 12
CO 1	3	2	1									
CO 2	3	2										
CO 3	3	2	1									
CO 4	3	1										
CO 5	3	1										

**Assessment Pattern**

Bloom Category	Continuous Assessment Tests		End Semester Examination
	1	2	
Remember	10	10	10
Understand	20	20	20
Apply	20	20	70
Analyse			
Evaluate			
Create			

**Mark distribution**

Total Marks	CIE	ESE	ESE Duration
150	50	100	3 hours

**Continuous Internal Evaluation Pattern:**

Attendance	: 10 marks
Continuous Assessment Test (2 numbers)	: 25 marks
Assignment/Quiz/Course project	: 15 marks

**End Semester Examination Pattern:** There will be two parts; Part A and Part B. Part A contain 10 questions with 2 questions from each module, having 3 marks for each question. Students should answer all questions. Part B contains 2 questions from each module of which student should answer any one. Each question can have maximum 2 sub-divisions and carry 14 marks.

**Course Level Assessment Questions:****Course Outcome 1 (CO1):**

1. What is meant by Standard atmosphere? Explain how the variation of pressure and density at different altitudes can be calculated.
2. With the help of a diagram explain the variation of temperature in different regions of atmosphere.

**Course Outcome 2 (CO2):**

1. Derive the expression for induced drag.
2. Write a summary of different drags that are acting on a 3D aerofoil.
3. With sketches compare the maximum lift produced by different high lift arrangements with that of a plane aerofoil.

**Course Outcome 3 (CO3):**

1. Derive the general two-dimensional translational equations of motion of an airplane in accelerated flight.
2. Explain how Froude's momentum theory can be used to calculate the efficiency of a propeller?
3. Show that at the velocity for minimum power required the airplane is flying at the angle of attack that corresponds to a maximum  $Cl^{3/2}/Cd$ .

**Course Outcome 4 (CO4):**

1. Explain the working of vertical speed indicator of an aircraft.
2. Explain the working of turn and bank indicator of an aircraft.
3. Explain the working of air temperature indicator of an aircraft.

**Course Outcome 5 (CO5):**

1. Explain the working of an indraft wind tunnel.
2. A low subsonic wind tunnel has a diffuser of area ratio 9. At a test section velocity of 30m/s and a temperature of 330K, the diffuser is found to have 90% efficiency. If the pressure at the inlet to the diffuser is  $1.195 \times 10^5 \text{ N/m}^2$ . Calculate the head loss in the diffuser.
3. Explain the working of supersonic wind tunnel.

**Model Question Paper**

APJ ABDUL KALAM TECHNOLOGICAL UNIVERSITY

VIII SEMESTER B.TECH DEGREE EXAMINATION

MET443: AEROSPACE ENGINEERING

Maximum: 100 Marks

Duration: 3 hours

**PART A**

Answer all questions, each question carries 3 marks

1. Explain the variation of temperature in various regimes of earth's atmosphere.
  2. Draw the pressure distribution around a 2-D aerofoil.
  3. Explain span efficiency factor.
  4. What is meant by aerodynamic center?
  5. What are the various propeller coefficients?
  6. Derive an expression for circular velocity.
  7. Define the terms Range and Endurance of an aircraft?
  8. How aerodynamic balancing of control surfaces is done in aircraft?
  9. What do you mean by wind tunnel balances?
  10. What is meant by range and endurance of an aircraft?
- (10 X 3 = 30 marks)

**PART B**

Answer one full question from each module

**Module 1**

11. a) What do you mean by temperature, pressure and density altitudes? (4 marks)
  - b) Consider an airplane flying at an altitude where the pressure and temperature are 25.37 Kpa and 216.66 K, respectively. Calculate the pressure and density altitudes at which the airplane is flying. (10 marks)
12. a) Explain how lift coefficient can be obtained from pressure coefficient. (4 marks)

- b) An aircraft having wing span 9.6m and wing area 17m<sup>2</sup> produces a lift of 80,000N when flying at 120m/s. Calculate the induced drag when flying at sea level, Assume  $e=0.8$  (10 marks)

### Module 2

13. a) An aircraft having wing span 9.6m and wing area 17m<sup>2</sup> produces a lift of 80000N when flying at 120m/s. Calculate the induced drag when flying at sea level, Assume  $e=0.8$  (10 marks)
- b) Write some methods to reduce the wing tip vortices. (4 marks)
14. a) Explain Prandl's lifting line theory? (4 marks)
- b) Explain how the prandl's lifting line theory can be used to calculate the aerodynamic characteristics of a finite wing. (10 marks)

### Module 3

15. a) Derive the expression for thrust required for a level unaccelerated flight. (8 marks)
- b) Obtain the condition for minimum thrust required for a level unaccelerated flight (6 marks)
16. a) What do you mean by power off glide? Derive the expression to find glide angle. (7 marks)
- b) Derive the Brequet range equation for a propeller driven airplane (7 marks)

### Module 4

17. a) What is meant by static and dynamic stability of an aircraft. (7 marks)
- b) With Sketch, explain the working of airspeed indicator. (7 marks)
18. a) Explain the working and functions of different gyroscopic instruments used in aircrafts. (7 marks)
- b) With the help of diagram, explain the working of different control surfaces of aircrafts. (7 marks)

### Module 5

19. a) Explain the types of engines used for subsonic aircraft. (7 marks)
- b) Define orbital velocity? Derive the expression for it. (7 marks)
20. a) Explain the working of an Indraft wind tunnel. (7 marks)
- b) Briefly explain important space missions of ISRO. (7 marks)

## Syllabus

### Module 1

The atmosphere - characteristics of troposphere, stratosphere, thermosphere, and ionosphere - pressure, temperature and density variations in the atmosphere. Application of dimensional analysis – aerodynamic force – model study and similitude. 2D aero foils -Nomenclature and classification- pressure distribution in inviscid and real flows- momentum and circulation theory of aero foil- characteristics.

### Module 2

3D or finite aero foils – effect of releasing the wingtips- wing tip vortices- replacement of finite wing by horse shoe vortex system, lifting line theory-wing load distribution – aspect ratio, induced drag calculation of induced drag from momentum considerations. Skin friction and from drag- changes in finite wing plan shape

### Module 3

Propellers – momentum and blade element theories –propeller coefficients and charts. Aircraft performance-straight and level flight –power required and power available graphs for propeller and jet aircraft. Gliding and climbing –rate of climb-service and absolute ceilings-gliding angle and speed of flattest glide takeoff and landing performance – length of runway required- aircraft ground run- circling flight – radius of tightest turn-jet and rocket assisted take –off high lift devices-range and endurance of airplanes-charts for piston and jet engine aircrafts.

### Module 4

Flight Instruments-airspeed indicator, calculation of true air speed-altimeter, gyro horizon - direction indicator-vertical speed indicator –turn and back indicator-air temperature indicator. (Brief description and qualitative ideas only). Ideas on stability-static and dynamic stability- longitudinal, lateral and directional stability- controls of an aero plane-aerodynamic balancing of control surfaces- mass balancing (Qualitative ideas only).

### Module 5

Principles of wind tunnel testing –open and closed type wind tunnels-wind tunnel balance supersonic wind tunnels. Study of subsonic, Transonic, and supersonic aircraft engines (Description with figures only).Elementary ideas on space travel-calculation of earth orbiting and escape velocities ignoring air resistance and assuming circular orbit.

### Text Books:

1. Anderson, Fundamentals of Aerodynamics, McGraw-Hill, 2010
2. A.C. Kermode, Mechanics of flight, Prentice Hall, 2007
3. EHJ Pallett, Aircraft Instruments and Integrated systems, Longman,1992

### Reference Books:

1. Houghton and Brock, Aerodynamics for Engineering Student, Hodder & Stoughton,1977

**Course Contents and Lecture Schedule**

<b>No.</b>	<b>Topic</b>	<b>No. of Lectures</b>
<b>1</b>	<b>Module 1</b>	
<b>1.1</b>	The atmosphere - characteristics of troposphere, stratosphere, thermosphere, and ionosphere - pressure, temperature and density variations in the atmosphere.	<b>3</b>
<b>1.21.2</b>	Application of dimensional analysis – aerodynamic force – model study and similitude	<b>1</b>
<b>.21.3</b>	2D aero foils -Nomenclature and classification- pressure distribution in inviscid and real flows- momentum and circulation theory of aero foil- characteristics.	<b>3</b>
<b>2</b>	<b>Module 2</b>	
<b>2.1</b>	3D or finite aero foils – effect of releasing the wingtips- wing tip vortices- replacement of finite wing by horse shoe vertex system, lifting line theory-wing load distribution – aspect ratio, induced drag calculation of induced drag from momentum considerations. Skin friction and from drag-changes in finite wing plan shape	<b>7</b>
<b>3</b>	<b>Module 3</b>	
<b>3.1</b>	Propellers – momentum and blade element theories – propeller coefficients and charts. Aircraft performance- straight and level flight –power required and power available graphs for propeller and jet aircraft.	<b>4</b>
<b>1.23.2</b>	Gliding and climbing –rate of climb-service and absolute ceilings-gliding angle and speed of flattest glide takeoff and landing performance – length of runway required- aircraft ground run- circling flight – radius of tightest turn- jet and rocket assisted take –off high lift devices-range and endurance of airplanes-charts for piston and jet engine aircrafts.	<b>4</b>
<b>4</b>	<b>Module 4</b>	
<b>4.1</b>	Flight Instruments-airspeed indicator, calculation of true air speed-altimeter, gyro horizon -direction indicator-vertical speed indicator –turn and back indicator-air temperature indicator.	<b>4</b>
<b>4.1</b>	Ideas on stability-static and dynamic stability-longitudinal, lateral and directional stability- controls of an aero plane- aerodynamic balancing of control surfaces-mass balancing	<b>3</b>
<b>5</b>	<b>Module 5</b>	

5.1	Principles of wind tunnel testing –open and closed type wind tunnels-wind tunnel balance supersonic wind tunnels. Study of subsonic, Transonic, and supersonic aircraft engines. Elementary ideas on space travel-calculation of earth orbiting and escape velocities ignoring air resistance and assuming circular orbit.	7
-----	----------------------------------------------------------------------------------------------------------------------------------------------------------------------------------------------------------------------------------------------------------------------------------------------------------------------------	---

APJ ABDUL KALAM  
TECHNOLOGICAL  
UNIVERSITY



CODE	COURSE NAME	CATEGORY	L	T	P	CREDIT
MET453	HYBRID AND ELECTRIC VEHICLES	PEC	2	1	0	3

**Preamble:** This course aims to introduce the students to general overview of Hybrid Electric vehicle, Architecture of Hybrid Electric Drive Trains, control of various motors and drive with its different configuration. The course will also cover the power transmission of Electric vehicles and its components. The energy storage system with its management, charging methods and various sensors of Electric vehicles has been included. This course also covers the vehicle validation with its integration, Hardware & Software Interfaces, Chassis design, and Battery Positioning of Hybrid Electric vehicle.

**Prerequisite:** Nil

**Course Outcomes:** After the completion of the course the student will be able to

CO 1	Explain the general architecture of Electric vehicles
CO 2	Describe various motors and drives of Electric vehicles
CO 3	Explain details of power transmission of Electric vehicles and select the appropriate components based on requirement
CO 4	Describe charging, various sensors and battery management of Electric vehicles
CO 5	Apply vector tool simulation, do vehicle validation, chassis design and battery positioning of Electric vehicles

Mapping of course outcomes with program outcomes

	PO 1	PO 2	PO 3	PO 4	PO 5	PO 6	PO 7	PO 8	PO 9	PO 10	PO 11	PO 12
CO 1	3	1	1									
CO 2	3	2	1									
CO 3	3	1	1									
CO 4	3	2	1									
CO 5	3	3	2	2								

**Assessment Pattern**

Bloom's Category	Continuous Assessment Tests		End Semester Examination
	1	2	
Remember	10	10	10
Understand	20	20	20
Apply	20	20	70
Analyse			
Evaluate			
Create			

**Mark distribution**

<b>Total Marks</b>	<b>CIE</b>	<b>ESE</b>	<b>ESE Duration</b>
150	50	100	3 hours

**Continuous Internal Evaluation Pattern:**

Attendance	: 10 marks
Continuous Assessment Test (2 numbers)	: 25 marks
Assignment/Quiz/Course project	: 15 marks

**End Semester Examination Pattern:** There will be two parts; Part A and Part B. Part A contain 10 questions with 2 questions from each module, having 3 marks for each question. Students should answer all questions. Part B contains 2 questions from each module of which student should answer any one. Each question can have maximum 2 sub-divisions and carry 14 marks.

**Course Level Assessment Questions****Course Outcome 1 (CO1):**

- 1 With the help of block diagram explain the major components of an electric vehicle
- 2 Explain the EV drivetrain alternatives based on power source configuration
- 3 Which are the resistive forces that retard the motion of a four-wheel vehicle? Show with a diagram

**Course Outcome 2 (CO2)**

- 1 How the electric motors used in EVs differs from that of used in industrial application
- 2 Explain the physical concept of torque production in Induction motor
- 3 Enlist the strategies for maintaining constant magnetic flux

**Course Outcome 3(CO3):**

- 1 What is field oriented control
- 2 Why higher number of gears are not used in Electric vehicle
- 3 Explain the single speed reduction in Electric vehicles

**Course Outcome 4 (CO4):**

- 1 Explain the battery charging and equalization
- 2 What is the importance of efficient battery thermal management in electric vehicle
- 3 Enlist different charging protocols in Electric vehicles

**Course Outcome 5 (CO5):**

- 1 What is the importance of electric vehicle validation
- 2 What is electric control unit in Electric vehicle
- 3 Where is the high voltage battery located in an electric vehicle

**Model Question Paper**

**APJ ABDUL KALAM TECHNOLOGICAL UNIVERSITY**  
SEVENTH SEMESTER B.TECH DEGREE EXAMINATION

**Course Code : MET453**

**Course Name : Hybrid and Electric vehicles**

Max. Marks : 100

Duration : 3 Hours

**PART – A**

**(ANSWER ALL QUESTIONS, EACH QUESTION CARRIES 3 MARKS)**

- 1 Differentiate between the design of Parallel HEV and Series HEV.
- 2 Identify the major components of the power train of a pure Electric vehicle.
- 3 Mention the type of electric motor suitable for an Electric vehicle. Substantiate your answer.
- 4 Give the sketch of a Brushless DC motor. Show the major parts in the sketch.
- 5 What are the basic switching elements used in EVs?
- 6 Give the significance of Power Speed Ratio as applied to an electric motor in an EV.
- 7 What is meant by a sensor? Identify any 3 sensors used in EVs and give their functions.
- 8 Explain how a regenerative braking system helps to increase the range of an EV.
- 9 Draw the basic architecture of CAN .Explain its function in HEV
- 10 What are the design issues encountered by a system integration engineer in HEV development ?

**PART – B**

**(ANSWER ONE FULL QUESTION FROM EACH MODULE)**

**Syllabus****Module 1**

- 11 a) With an example, explain the socio economic impact of EVs in the Indian Scenario  
(8 Marks)
- b) Why the first generation EVs had a premature death? In your opinion who is behind this ? .Give the facts to substantiate your answer.  
(6 Marks)

Compute Forces due to drag, rolling resistance and gradient for the following vehicles assuming  $\rho = 1.2 \text{ (kg/m}^3\text{)}$  and  $\theta = 8^\circ$ . For the three vehicles given in the table, find Aerodynamic drag at velocity  $v_1$  and  $v_2$ ; also find rolling resistance at two velocities.

Vehicle	GVW (kg)	$C_D$	Area(sqm)	$\mu$	$v_1$ (kmph)	$v_2$ (kmph)	Tyre radius (m)
2-wheeler	200	0.9	0.6	0.015	30	80	0.28
3-wheeler	600	0.45	1.6	0.015	30	80	0.2
4-wheeler	1500	0.3	2.5	0.015	30	80	0.3

( 7 Marks)

b) What are the basic functions of a Power train ? Illustrate the concept in HEV scenario.

(7 Marks)

### Module 2

- 13 a) Differentiate between SPM and IPM based on Torque characteristics (8 Marks)  
 b) A vehicle is cruising at 36 kmph, the applied voltage is 25V, the BEMF is 24V and the winding resistance is 20 m $\Omega$   
 How much current is the motor drawing?  
 What is the power delivered to the vehicle?  
 What is the load torque due to the vehicle, reflected on the motor?  
 What is the efficiency of the motor?  
 If the applied voltage were increased by 1V, what will be the final speed of the vehicle? (6 Marks)

- 14 a) What are the latest innovations in the design of high efficiency magnets ? Explain (7 Marks)  
 b) What are the important losses during electric to mechanical conversion in EVs? (7 Marks)

### Module 3

- 15 a) Why a gear system is needed in EVs ? Explain with a comparison with its ICE counterpart (7 Marks )  
 b) What are the basic function of a motor controller ? Explain its role in the performance of EV in various terrains (7 Marks)
- 16 a) Why gear optimization in needed inEVs ? Explain with a practical example. (8 Marks )  
 b) An EV has a DC source but works on AC motor. Explain in detail how the conversion is carried out ? (6 Marks)

**Module 4**

- 17 a) How battery selection is done in EVs? Explain by taking an Electric scooter as an example . (8 Marks)
- b) A 3.5 V battery is at 2.7 V at SOC of 0% and 4.3 V at 100%. This implies the voltage of the battery lies in between  $3.5 \pm \Delta$  % volts . What is Delta? (6 Marks)
- 18 a) Explain the design procedure of a BMS for an E-rikshaw right from the requirements (10 Marks)
- b) Explain active thermal management in battery pack design. (6 Marks)

**Module 5**

- 19 a) Draw the electric diagram showing interconnections between a)ECU b)ABS sensor  
c) Air conditioner using CAN protocol in HEV and explain its working (7 Marks)
- b) What are the major hurdles faced in HEV integration? Explain by taking an Electric truck as an example (7 Marks)
- 20 a) What are the features differ in the design of chassis for a conventional ICE and HEV (7 Marks)
- b) What are the challenges in the hardware /software interfacing in an HEV? Explain based on an example. (7 Marks)

**Syllabus****Module 1**

Introduction to Hybrid Electric Vehicles(HEV): History of hybrid and electric vehicles, social and environmental importance of hybrid and electric vehicles. Types of EVs, Review of Vehicle dynamics; Hybrid Electric Drive train. General configuration of Electric hybrid vehicles. Electric Vehicle (EV) Drive train Alternatives Based on Drive train Configuration.

**Module 2**

Induction motors and drives, configuration, controls and applications in EV/HEV's; Permanent magnet motors-neodymium and ferrite and samarium cobalt types and drives configuration, Brushless DC Motor (BLDC), Interior Permanent magnet (IPM), Switch reluctance motors (SRM) W-Axial,3 phase Induction controls and applications in EV/HEV's

**Module 3**

Motor Controllers/Inverters, Selection of automotive IGBT and MOSFET's, Field Oriented Control (FOC) & Space Vector Pulse Width Modulation (SVPWM) of Motors, Gearbox, selection of gear ratio, Different kinds of gearboxes, Gearbox optimisation, Transmission, Different kinds of transmission.

**Module 4**

EV charging, Fast charger, DC charger, AC charger, Battery swapping, Different charging protocols CHAdeMO, CCS2, GB/T, Customised charging protocols, Battery Box Engineering, Battery Management Bus Bar design, Battery Pack Design, Various Sensors and Sensing methods, Battery Safety Standards, Thermal Management – Battery

**Module 5**

Vehicle Validation, System Integration, Controller Area Networking (CAN) and Vector Tools Simulation, Vehicle Sensors specific to EV sensors interfaced to the ECU's in the vehicle network, Hardware & Software Interfaces and Implementation challenges and examples to solve, Chassis design, Battery Positioning.

**Text Books**

1. Husain I, "Electric and Hybrid Vehicles": Design Fundamentals Boca Raton, CRC Press 2003

**Reference Books**

1. James Larminie, John Lowry, Electric Vehicle Technology Explained, Wiley, 2003. 2.
2. Mehrdad Ehsani, Yimi Gao, Sebastian E. Gay, Ali Emadi, Modern Electric, Hybrid Electric and Fuel Cell Vehicles: Fundamentals, Theory and Design, CRC Press, 2004.
3. Iqbal Hussein, Electric and Hybrid Vehicles: Design Fundamentals, CRC Press, 2003.
4. Sandeep Dhameja, "Electric Vehicle Battery Systems", Newnes, 2000  
<http://nptel.ac.in/courses/108103009/>

**Course Contents and Lecture Schedule**

No	Topic	No. of Lectures
1	<b>Module 1</b>	<b>8 Hours</b>
1.1	Introduction to Hybrid Electric Vehicles(HEV): History of hybrid and electric vehicles	2
1.2	social and environmental importance of hybrid and electric vehicles	1
1.3	Types of EVs,	1
1.4	Review of Vehicle dynamics;	2
1.5	Hybrid Electric Drive train. General configuration of Electric hybrid vehicles	1
1.6	Electric Vehicle (EV) Drive train Alternatives Based on Drive train Configuration.	1
2	<b>Module 2</b>	<b>8 Hours</b>
2.1	Induction motors and drives, configuration, controls and applications in EV/HEV's	2
2.2	Permanent magnet motors	1
2.3	neodymium and ferrite and samarium cobalt types and drives configuration	1
2.4	Brushless DC Motor (BLDC), Interior Permanent magnet (IPM),	

2.5	Switch reluctance motors (SRM	2
2.6	W-Axial,3 phase Induction controls and applications in EV/HEV's	1
	3 phase Induction controls and applications in EV/HEV's	1
3	<b>Module 3</b>	<b>7 Hours</b>
3.1	Motor Controllers/Inverters, Selection of automotive IGBT and MOSFET's	2
3.2	Field Oriented Control (FOC) & Space Vector Pulse Width Modulation (SVPWM) of Motors	1
3.3	Gearbox, selection of gear ratio, Different kinds of gearboxes	2
3.4	Gearbox optimisation, Transmission,	1
3.5	Different kinds of transmission	1
4	<b>Module 4</b>	<b>7 Hours</b>
4.1	EV charging, Fast charger, DC charger, AC charger, Battery swapping	1
4.2	Different charging protocols CHAdeMO,CCS2,GB/T, Customised charging protocols,	2
4.3	Battery Box Engineering, Battery Management	1
4.4	Bus Bar design, Battery Pack Design	1
4.5	Various Sensors and Sensing methods,	1
4.6	Battery Safety Standards, Thermal Management – Batter	1
5	<b>Module 5</b>	<b>7 Hours</b>
5.1	Vehicle Validation, System Integration	1
5.2	Controller Area Networking (CAN) and Vector Tools Simulation,	1
5.3	Vehicle Sensors specific to EV sensors interfaced to the ECU's in the vehicle network,	2
5.4	Hardware & Software Interfaces	1
5.5	and Implementation challenges and examples to solve	1
5.6	Chassis design, Battery Positioning	1

Estd.



2014

CODE	COURSE NAME	CATEGORY	L	T	P	CREDIT
MET463	OPERATIONS MANAGEMENT	PEC	2	1	0	3

**Preamble:** This course is designed to facilitate the students to acquire knowledge about operations management concepts, tools and techniques. This course covers system concept of production, facility location analysis, facility layout, line balancing, demand forecasting, aggregate planning, material requirement planning and production scheduling. It empowers the students to amalgamate their knowledge and thus inculcate the skills needed to apply these concepts, tools and techniques in industry.

**Prerequisite:** Nil

**Course Outcomes:** After the completion of the course the student will be able to

CO 1	Understand operations, production system and perform facility location analysis.
CO 2	Impart knowledge of facility layout, layout planning and perform line balancing.
CO 3	Compute demand forecast and forecast accuracy.
CO 4	Perform aggregate planning and materials requirement planning.
CO 5	Apply various algorithms for production scheduling.

#### Mapping of Course Outcomes with Program Outcomes

	PO 1	PO 2	PO 3	PO 4	PO 5	PO 6	PO 7	PO 8	PO 9	PO 10	PO 11	PO 12
CO 1	2	2				1		1		1	2	2
CO 2	3	3	2	1	2					1	2	2
CO 3	3	3	2	1	1					1	2	2
CO 4	3	3	2		1					1	2	2
CO 5	3	3	2	1	1					1	2	2

#### Assessment Pattern

Bloom's Category	Continuous Assessment Tests		End Semester Examination
	1	2	
Remember	10	10	10
Understand	20	20	30
Apply	20	20	60
Analyse			
Evaluate			
Create			

**Mark Distribution**

Total Marks	CIE	ESE	ESE Duration
150	50	100	3 hours

**Continuous Internal Evaluation Pattern:**

Attendance	: 10 marks
Continuous Assessment Test (2 numbers)	: 25 marks
Assignment/Quiz/Course Project	: 15 marks

**End Semester Examination Pattern:** There will be two parts; Part A and Part B. Part A contain 10 questions with 2 questions from each module, having 3 marks for each question. Students should answer all questions. Part B contains 2 questions from each module of which student should answer any one. Each question can have maximum 2 sub-divisions and carry 14 marks.

**Course Level Assessment Questions****Course Outcome 1 (CO1):**

1. Demonstrate the concept of operations management.
2. List the type of production system with examples.
3. Determine the location of a facility.

**Course Outcome 2 (CO2):**

1. List different types of facility layouts with examples.
2. Describe layout design procedures.
3. Group the activities for line balancing.

**Course Outcome 3 (CO3):**

1. Demonstrate need and uses of demand forecasting.
2. Compute demand forecast.
3. Compare demand forecasts from different methods.

**Course Outcome 4 (CO4):**

1. Compare aggregate planning strategies.
2. Demonstrate lot sizing techniques for MRP.

3. Compute MRP tables.

**Course Outcome 5 (CO5):**

1. Illustrate the concept of production scheduling.
2. Identify scheduling objectives might be appropriate for different manufacturing environments.
3. Find production schedule using various techniques.

**Model Question Paper**

**APJ ABDUL KALAM TECHNOLOGICAL UNIVERSITY  
SEVENTH SEMESTER B. TECH DEGREE EXAMINATION**

**Course Code: MET463**

**Course Name: OPERATIONS MANAGEMENT**

**Max. Marks: 100**

**Duration: 3 Hours**

**PART A**

**(ANSWER ALL QUESTIONS, EACH QUESTION CARRIES 3 MARKS)**

1. What are the criteria for make or buy decisions.
2. Explain how you would reengineer a process you find troubling.
3. How does a cellular layout combine a product and process layout?
4. State the basic differences between construction type and improvement type layout algorithms.
5. Describe the difference between short- and long-range forecasts.
6. What is the difference between a trend and a cycle and a seasonal pattern?
7. Differentiate between level production strategy and chase demand strategy.
8. What are the basic inputs for MRP?
9. Explain the concept of single machine scheduling problem.
10. What is Gantt chart and when are they used so often?

**PART B**

**(ANSWER ONE FULL QUESTION FROM EACH MODULE, EACH QUESTION CARRIES 14 MARKS)**

**MODULE 1**

11. What activities are involved in the operations function? How do operations interact with other functional areas?
12. A development company is attempting to determine the location for a new outlet mall. The region where the outlet mall will be constructed includes four towns, which together

have a sizable population base. The grid map coordinates of the four towns and the population of each are as follows:

Town	Coordinates		Population (10,000s)
	x	y	
1	30	60	6.5
2	50	40	4.2
3	10	70	5.9
4	40	30	3.5

- Determine the best location for the outlet mall using the centre-of-gravity method.
- Plot four towns and the location of the new mall on a grid map.

### MODULE 2

13. Describe systematic layout planning. Narrate the steps of CRAFT and ALDEP.

14. Consider the following assembly network relationships of a product. The number of shifts per day is two and the number of working hours per shift is 8. The company aims to produce 80 units of product per day. Group the activities into workstations using rank positional weight method and compute balancing efficiency.

Operations Number	1	2	3	4	5	6	7	8	9	10
Immediate Preceding Tasks	-	1	1	1	2, 3	3, 4	5	5, 6	4, 6	7, 8, 9
Duration (min)	7	2	2	5	8	3	4	7	9	8

### MODULE 3

15. What the effect on the exponential smoothing model will increasing the smoothing constant have? How does adjusted exponential smoothing differ from exponential smoothing? What determines the choice of the smoothing constant for trend in an adjusted exponential smoothing model?

16. The following table represents the sales data of milk (in litres) sold by a milk booth.

Month	1	2	3	4	5	6	7	8
Sales	90	106	92	114	108	98	99	115

- Compute a 3-month moving average forecast for months 4 through 9.
- Computer a weighted 3-month moving average forecast for months 4 through 9. Assign weights of 0.50, 0.30, and 0.20 to the months in sequence, starting with the most recent month.
- Compare the two forecasts using MAD. Which forecast appears to be more accurate?

### MODULE 4

17. Describe the output of aggregate planning. When is aggregate planning most useful? Discuss the advantages and disadvantages of using part time workers, subcontracting work, and building up inventory as strategies for meeting demand.

18. Given the following Product structure, BOM, MPS and inventory status, compute MRP tables for all items.

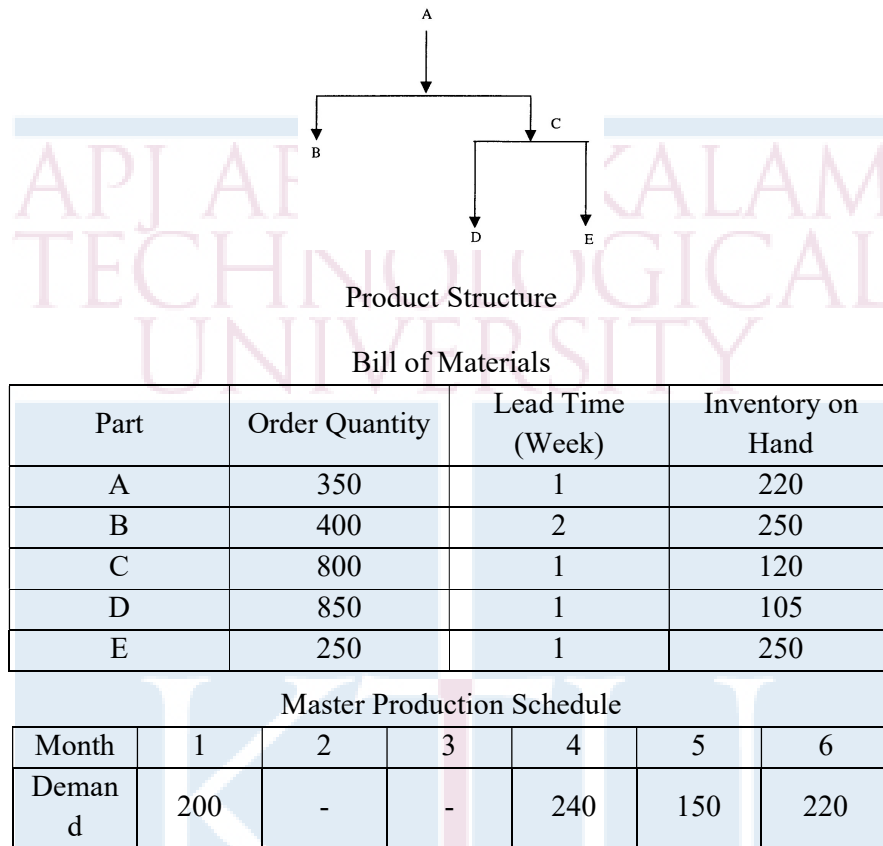

### MODULE 5

19. Define the term 'scheduling'. Explain the different performance measures in scheduling? Give examples of four types of operations and suggest which scheduling objectives might be appropriate for each.

20. Consider the following n jobs parallel identical machines problem

Job - j	1	2	3	4	5	6	7	8	9
$t_j$	5	21	16	6	25	19	20	10	6
$w_j$	3	2	4	2	4	3	1	2	1

Find the schedule which will minimize the weighted mean flow time, if the number of parallel identical machines is three.

## Syllabus

### Module 1

Introduction to operations management: operations function, operations strategy, system concept of production, types of production system – job shop production – batch production – mass production, process planning, make or buy decisions, process reengineering.

Facilities location: Facility location factors, location analysis techniques – location factor rating – center of gravity technique – load distance technique. (7 hours)

### Module 2

Capacities and facilities: capacity planning, facility layout – objectives, types of layout – process layout – product layout – fixed position layout – cellular layout, systematic layout planning, layout design procedures – CRAFT – CORELAP – ALDEP.

Assembly line balancing: methods for line balancing – rank positional weight method – COMSOAL. (7 hours)

### Module 3

Demand forecasting: need and uses of forecasting, components of forecasting demand, time series methods – moving average – weighted moving average – exponential smoothing – adjusted exponential smoothing – linear regression – seasonal adjustments, forecast accuracy. (7 hours)

### Module 4

Aggregate planning: aggregate planning strategies – heuristic method for aggregate planning.

Materials requirement planning: objectives, master production schedule, bill of materials, MRP calculations, lot sizing in MRP – economic order quantity method for lot sizing – minimum cost per period method – periodic order quantity method – least unit cost method, evolution from MRP to manufacturing resource planning (MRP II). (7 hours)

### Module 5

Introduction to production scheduling: objectives – processing characteristics and constraints – performance measures, Gantt chart, single machine scheduling – SPT rule to minimize mean flow time – EDD rule to maximum lateness, parallel processors – minimization of makespan – mean weighted flow time – McNaughton's algorithm, flow shop scheduling – extension of Johnson's rule for 3 machine problem – Palmer's heuristic. (7 hours)

### Text Books

1. Roberta S. Russell and Bernard W. Taylor III, Operations Management, John Wiley & Sons, Inc., Seventh Edition, 2011.
2. R. Panerselvam, Production and Operations Management, PHI, 2010

**Reference Books**

1. P. B. Mahapatra, Operations Management: A Quantitative Approach, PHI, 2010
2. G. Sreenivasan, Quantitative Models in Operations and Supply Chain Management, PHI.
3. Heizer and Render, Operations Management, Pearson Education, Eleventh Edition

**Course Contents and Lecture Schedule**

No	Topic	No. of Lectures
1	<b>Module 1</b>	
1.1	Introduction to operations management: operations function, operations strategy, system concept of production, types of production system – job shop production – batch production – mass production.	3
1.2	Process planning, make or buy decisions, process reengineering.	2
1.3	Facilities location: Facility location factors, location analysis techniques – location factor rating – center of gravity technique – load distance technique.	2
2	<b>Module 2</b>	
2.1	Capacities and facilities: capacity planning, facility layout – objectives, types of layout – process layout – product layout – fixed position layout – cellular layout.	2
2.2	Systematic layout planning, layout design procedures – CRAFT – CORELAP – ALDEP.	3
2.3	Assembly line balancing: methods for line balancing – rank positional weight method – COMSOAL.	2
3	<b>Module 3</b>	
3.1	Demand forecasting: need and uses of forecasting, components of forecasting demand.	2
3.2	Time series methods – moving average – weighted moving average – exponential smoothing – adjusted exponential smoothing.	3
3.3	Linear regression – seasonal adjustments, forecast accuracy.	2
4	<b>Module 4</b>	
4.1	Aggregate planning: aggregate planning strategies – heuristic method for aggregate planning.	3
4.2	Materials requirement planning: objectives, master production schedule, bill of materials, MRP calculations, lot sizing in MRP – economic order quantity method for lot sizing – minimum cost per period method – periodic order quantity method – least unit cost method.	3
4.3	Evolution from MRP to manufacturing resource planning (MRP II).	1
5	<b>Module 5</b>	

5.1	Introduction to production scheduling: objectives – processing characteristics and constraints – performance measures, Gantt chart.	2
5.2	Single machine scheduling – SPT rule to minimize mean flow time – EDD rule to maximum lateness, parallel processors – minimization of makespan – mean weighted flow time – McNaughton's algorithm.	3
5.3	Flow shop scheduling – extension of Johnson's rule for 3 machine problem – Palmer's heuristic.	2

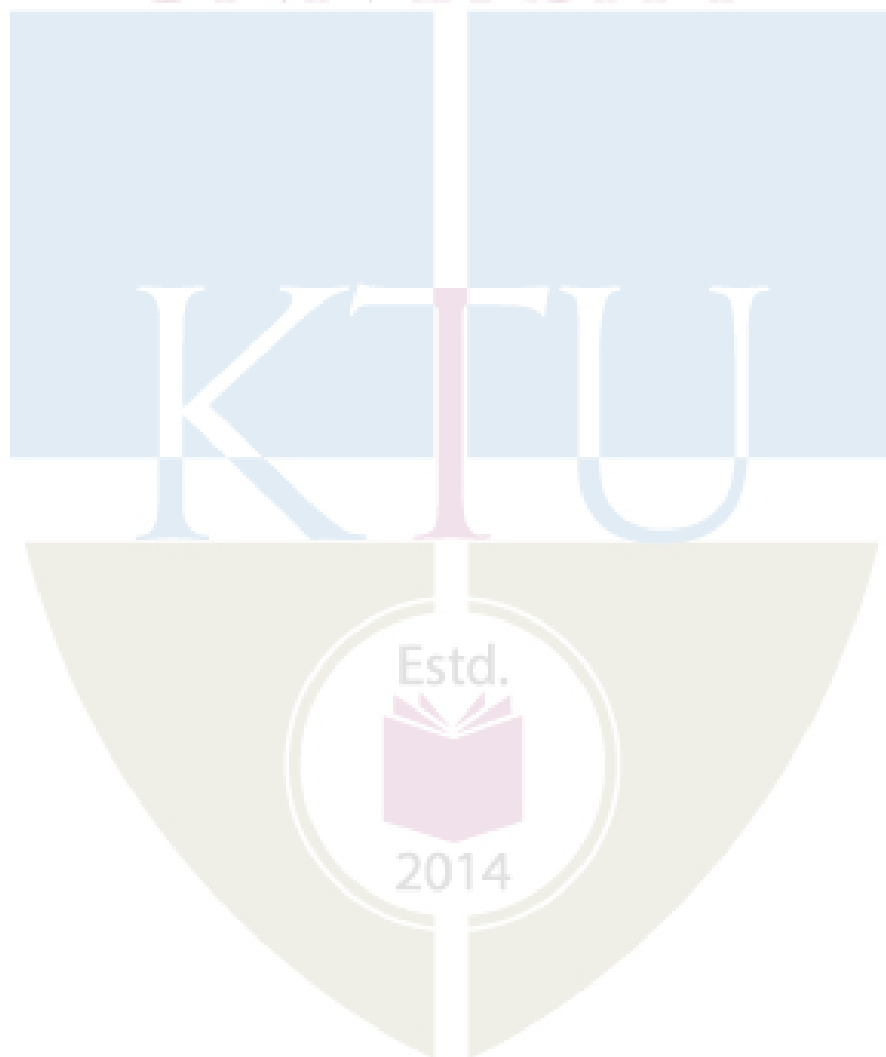

CODE	COURSE NAME	CATEGORY	L	T	P	CREDIT
MET473	AIR CONDITIONING AND REFRIGERATION	PEC	2	1	0	3

**Preamble:** The objectives of the course are:

- To introduce refrigeration and air conditioning systems.
- To impart knowledge in basics of vapour compression system and methods to improve efficiency.
- To understand working principle of vapour absorption refrigeration and steam jet refrigeration.
- To familiarize the components of refrigeration systems and to select environment friendly refrigerants
- To determine the capacity requirement of ac machine for an application.

**Pre-requisite:** MET 202 Engineering Thermodynamics.

**Course Outcomes:** After the completion of the course the student will be able to

CO 1	Explain the basics of refrigeration process.
CO 2	Analyse the vapour compression refrigeration system and to improve the performance.
CO 3	Describe vapour absorption and steam refrigeration system.
CO 4	Design refrigeration system by selecting suitable components and environmentally refrigerant.
CO 5	Evaluate the cooling load and capacity requirement of ac machine

**Mapping of course outcomes with program outcomes**

	PO 1	PO 2	PO 3	PO 4	PO 5	PO 6	PO 7	PO 8	PO 9	PO 10	PO 11	PO 12
CO 1	3			1								1
CO 2	3	2		2								1
CO 3	3	2		2								1
CO 4	3	1				2	3					1
CO 5	3	2	2				1					2

**Assessment Pattern**

Bloom's Category	Continuous Assessment			End Semester Examination
	Assignment (%)	Test 1 (%)	Test 2 (%)	
Remember	25	20	20	10
Understand	25	40	40	20
Apply	25	40	40	70
Analyse	25			
Evaluate				
Create				

**Mark distribution**

Total Marks	CIE	ESE	ESE Duration
150	50	100	3 hours

**Continuous Internal Evaluation Pattern:**

Attendance	: 10 marks
Continuous Assessment Test (2 numbers)	: 25 marks
Assignment/Quiz/Course project	: 15 marks

**End Semester Examination Pattern:** There will be two parts; Part A and Part B. Part A contain 10 questions with 2 questions from each module, having 3 marks for each question. Students should answer all questions. Part B contains 2 questions from each module of which student should answer any one. Each question can have maximum 2 sub-divisions and carry 14 marks.

**Course Level Assessment Questions****Course Outcome 1 (CO1):**

1. Define COP of a refrigeration machine and heat pump?
2. What is a boot strap refrigeration system?
3. Why aircrafts prefer air refrigeration system?

**Course Outcome 2 (CO2)**

1. Explain Vapour refrigeration system with the help of pressure- enthalpy diagram?
2. Explain flash inter-cooling method of improving efficiency of vapour compression system?

3. Explain cascade system with the help of neat diagram?

**Course Outcome 3 (CO3):**

1. Describe steam jet refrigeration system with the help of neat diagram?
2. Explain Lithium Bromide water absorption system. What are the advantages over ammonia absorption system?
3. Compare vapour absorption system with vapour compression system?

**Course Outcome 4 (CO4):**

1. Explain ODP and GWP of a refrigerant?
2. Explain scroll compressor with the help of neat sketch?
3. Explain the working principle and use of cooling tower with the help of a neat sketch?

**Course Outcome 5 (CO5):**

1. An Auditorium has seating capacity 800 people is to be maintained at 23°C DBT and 50% RH. The outdoor conditions are 40°C DBT and 27°C WBT. The various loads in the office are: Solar heat gain 10KW, sensible heat gain per occupant 80W, Latent heat per occupant 70W, Lighting load 5KW, Sensible heating load from other sources 12KW, Infiltration load 0.3m<sup>3</sup>/sec. Outdoor air and return air is mixed in the ratio of 1: 6, before cooling coil (processing unit) and then supplied to room. The supply temperature cannot be lower than 12°C. Find capacity of the plant required, mass flow rate of air?
2. What is ESR, ISEER, GSHF and RSHF? Explain?
3. Explain different psychrometric process and represent it in a psychrometric chart?

Estd.



2014

**Model Question Paper****APJ ABDUL KALAM TECHNOLOGICAL UNIVERSITY****MET 473- AIR CONDITIONING AND REFRIGERATION.****Maximum: 100 Marks****Duration: 3 hours****PART A****Answer all questions. Each question carries 3 marks**

1. Define COP of a refrigeration machine and heat pump?
2. Why aircrafts prefer air refrigeration system?
3. Explain Vapour refrigeration system with the help of pressure- enthalpy diagram?
4. Write sub cooling of condenser out let method improving COP of vapour compression system with the help of p-h diagram.
5. Compare vapour absorption system with vapour compression system?
6. Compare steam jet refrigeration system with vapour compression system?
7. Explain ODP and GWP of a refrigerant?
8. Explain the method of detection of leakage of refrigerant?
9. What are ESR, ISEER, GSHF and RSHF?
10. What is IPLV of an air conditioner? (10 X 3 = 30 Marks)

**PART B****Answer one full question from each module****MODULE 1**

11. a. Explain the application of refrigeration? 4 marks
- b. A boot strap air refrigeration system is used for a flight to takes 20 TONS of cooling loads. The ambient conditions are air conditions are  $5^{\circ}\text{C}$  and 0.85 Bar. The air pressure increases to 1.1 bars due to ramming action, which is considered to be ideal. The output pressure of the main air compressor is 3.5 Bar and this is further compressed in the secondary compressor to 4.5 Bar. The isentropic efficiency of both main and secondary compressors is 90% and that of cooling turbine is 80%. Heat exchanger effectiveness is 0.6, for both primary and secondary heat exchangers. Determine: Power required taking the cabin load; COP of the system, the turbine runs the secondary compressor and uses its surplus power to run the fan for blowing ram air, Cabin to be maintained at pressure as 1 Bar,  $25^{\circ}\text{C}$ ?

10 marks

12. a. What are the limitations of Carnot refrigeration cycle? 4 marks
- b. In an aero plane uses air-refrigeration system, the air at 5 bars and 200°C is bled-off from the main compressor and is cooled in a heat exchanger with the use of ram air. The pressure and temperature of the air leaving the heat exchanger are 4.5 bar and 40°C. The ram air is forced through the heat exchanger by a fan run by expander turbine. The air coming out from the heat exchanger is passed through an expander and then supplied to the cabin at 1 bar, the pressure loss between the expander and cabin is 0.2 bars. If the air flow rate through the expander turbine is 30 kg/min. find the followings- The temperature of the air leaving the expander, The kW delivered to the ram air which is passed through the heat exchanger, The refrigeration capacity in tons of refrigeration if the cold air coming out from the expander turbine is tempered by mixing with bypassed warm air and delivered to the cabin. The temperature of the air leaving the cabin is limited to 25° C. Assume the followings:  
Isentropic efficiency of the expander turbine = 75%.  
 $\gamma$  (for air) = 1.4,  $C_p$  (for air) = 1KJ/kg-K  
Neglect heat losses. 10 marks

### MODULE II

13. a. A refrigerating machine using F12 as working fluid works between the temperatures 18°C and 37°C. The enthalpy of liquid at 37°C is 72 KJ/kg. The enthalpies of F12 entering and leaving the compressor are 195 KJ/kg and 227 KJ/kg respectively. The rate of circulation of refrigerant is 2 kg/min and efficiency of compressor is 85% Determine; Capacity of the plant in TONS of refrigeration. Power required running the plant, COP of the plant? 7 marks
- b. Explain Sub cooling by liquid vapour regenerative heat exchanger method of improving COP of vapour compression system with the help of necessary sketch? . 7 marks
14. a. A simple vapour compression cycle using Freon 22 is designed for a load of 100 TR. The suction condition of the refrigerant is saturated vapour at 5°C and discharge condition is super heated at 40°C. Calculate (a) The mass flow rate of refrigerant; (b) The COP.? 7 marks
- b. Explain the Multi stage compression (with flash inter cooling) method of improving COP with the help of line diagram and P- h diagram? 7 marks

### MODULE III

- 15.a. Electrolux vapours absorption system of refrigeration with the help of line diagram? 7 marks
- b. explains Steam jet refrigeration system with the help of line diagram what are the applications, relative merits and demerits? 7 marks

16. a. Explain Lithium Bromide water system. What are the merits and demerits of the system? 8 marks
- b. Compare water absorption system and vapour compression system? What are the relative merits and demerits? 6 marks

#### MODULE IV

17. a. Explain different types of refrigerants available and their relative merits and demerits? 7 marks
- b. Explain the working of Scroll compressor with the help of neat sketch? 7 marks
- 18.a. Explain reciprocating compressor with the help of neat diagram? What are the relative merits and demerits? 7 marks
- b. Explain working of a cooling tower with the help of a neat sketch. What are the applications of cooling tower? 7 marks

#### MODULE V

- 19a. An Auditorium has seating capacity 800 people is to be maintained at 23°C DBT and 50% RH. The outdoor conditions are 40°C DBT and 27°C WBT. The various loads in the office are: Solar heat gain 10KW, sensible heat gain per occupant 80W, Latent heat per occupant 70W, Lighting load 5KW, Sensible heating load from other sources 12KW, Infiltration load 0.3m<sup>3</sup>/sec. Outdoor air and return air is mixed in the ratio of 1: 6, before cooling coil (processing unit) and then supplied to room. The supply temperature cannot be lower than 12<sup>0</sup>C. Find capacity of the plant required, mass flow rate of air 12 marks
- b. Define absolute humidity and relative humidity? 2 marks
- 20 a. An office for seating 30 occupants is to be maintained at 22°C DBT and 55% RH. The outdoor conditions are 36°C DBT and 27°C WBT. The various loads In the office are: Solar heat gain 8500W, Sensible heat gain per occupant 83W, Latent heat gain per occupant 100W, Lighting load 2500W, Sensible heat load from other sources 12000W, infiltration load 15 cubic meter/minute. Assuming 40% fresh air and 60% of re-circulated air passing through the evaporator coil and ADP of the coil is 8<sup>0</sup>C. Find capacity of the plant and mass flow rate of air? 12 marks
- b. What is dew point temperature and represent it in the psychrometric chart? 2 marks

## Syllabus

### Module 1- Introduction to refrigeration

Introduction –applications of refrigeration. Thermodynamics of refrigeration- reversed Carnot cycle, Limitations, heat pump, COP, Unit of refrigeration- Air refrigeration systems- Reversed Joule cycle, Air craft refrigeration systems, comparison, Boot strap system. Numerical examples.

### Module 2 Vapour compression refrigeration.

Vapour compression systems- representation on T- s and P- h Diagrams. COP- Effect of operating parameters on COP – methods of improving COP of simple cycle- super- heating , under cooling, Liquid suction heat exchanger, actual cycle. Multi pressure systems - multi compression and multi evaporator, systems, Inter cooling - flash inter cooling and flash gas removal- numerical examples, Cryogenic temperature system, Cascade system.

### Module 3 Vapour absorption and steam jet refrigeration.

Vapour absorption systems - Ammonia – water system - simple system- drawbacks- Lithium Bromide water system- Electrolux- comparison with vapour compression system. Steam jet refrigeration. Applications, relative merits and demerits.

### Module 4 Refrigeration system components

Refrigeration system components- Compressors, condensers, expansion devices, evaporators. Cooling towers- Different types and their application fields- Refrigerant leakage and detection – charging of refrigerant.

Refrigerants and their properties, CFC, HCFC, HFC, HC refrigerants -Eco-friendly Refrigerants, ODP, GWP, selection of refrigerants for different applications

### Module 5 Air conditioning.

Psychrometric, Psychrometric properties- dry, wet and dew point temperature – humidity, specific humidity, absolute humidity, relative humidity and degree of saturation- enthalpy of moisture- adiabatic saturation process -psychrometers. psychrometric chart- Psychrometric processes- adiabatic mixing- sensible heating and cooling- humidifying and dehumidifying, air washer – bypass factor- sensible heat factor-RSHF and GSHF line- Design condition- Apparent dew point temperature – Numerical examples.

Air conditioning- applications, Comfort air conditioning- factors affecting human comfort. Effective temperature – comfort chart. Unitary and central system comparison. Capacity determination-cooling load estimation. COP, EER, IEER, IPLV, star rating, specification of capacity TONs, HP, Numerical examples.

**Text Books**

1. Refrigeration and Air Conditioning, Arora C.P, Tata McGraw hill.
2. A Course in Refrigeration and air conditioning Arora S. C. and S. Domkundwar, Dhanpat Rai and Company. 2002
3. A text book of Refrigeration and air conditioning – R.K .Regiput, Katson books.
4. Refrigeration and air conditioning - Ahamadul Ameen Eastern economy addition.
5. Heating, Ventilating, and Air Conditioning: Analysis and Design, Faye C. Mcquiston, Jerald D. Parker, Jeffrey D. Spitler, John Wiley and sons. New York

**Data books**

1. Refrigeration tables and charts including air conditioning data, C P Kothandaraman , New Age International.
2. Refrigeration and air conditioning data book, Domkunduwar and Domkundwar, Dhanpat Rai & co.

**Reference books**

1. ASHRAE Handbook 201(Volume 1,2,3)
2. Principles of heating ventilation and air conditioning in building, john Dixon, Delmar learning
3. Analysis and design of heating ventilation and air conditioning system, Herbert W stanferd and Adam F spach, CRC press -Taylor and Francis.

**Course Contents and Lecture Schedule**

<b>MODULE</b>	<b>TOPICS</b>	<b>HOURS ALLOTTED</b>
<b>1</b>	Introduction –applications of refrigeration.	<b>2-0-0</b>
	Thermodynamics of refrigeration- reversed Carnot cycle, Limitations, heat pump, COP ,Unit of refrigeration- Air refrigeration systems- Reversed Joule cycle, Air craft refrigeration systems, comparison.	<b>2-1-0</b>
	Boot strap system. Numerical examples	<b>2-1-0</b>
<b>2</b>	Vapour compression systems- representation on T- s and P- h Diagrams. COP- Effect of operating parameters on COP	<b>2-1-0</b>
	methods of improving COP of simple cycle- super- heating , under cooling, Liquid suction heat exchanger, actual cycle.Multi pressure systems - multi compression and multi evaporator, systems, Inter cooling - flash inter cooling and flash gas removal-	<b>2-1-0</b>

	numerical examples .	
	Cryogenic temperature system, Cascade system.	<b>2-0-0</b>
<b>3</b>	Vapour absorption systems - Steam jet refrigeration. Applications, relative merits and demerits - simple system- drawbacks-Lithium Bromide water system.	<b>3-1-0</b>
	Electrolux- comparison with vapour compression system.	<b>1-0-0</b>
	Steam jet refrigeration. Applications, relative merits and demerits	<b>1-0-0</b>
<b>4</b>	Refrigeration system components- Compressors, condensers, expansion devices, evaporators.	<b>2-1-0</b>
	Cooling towers- Different types and their application fields- Refrigerant leakage and detection – charging of refrigerant.	<b>2-0-0</b>
	Refrigerants and their properties, CFC, HCFC, HFC, HC refrigerants -Eco-friendly Refrigerants, ODP, GWP, selection of refrigerants for different applications.	<b>2-0-0</b>
<b>5</b>	Psychrometric, Psychrometric properties- dry, wet and dew point temperature – humidity, specific humidity, absolute humidity, relative humidity and degree of saturation- enthalpy of moisture-adiabatic saturation process -psychrometers. psychrometric chart- Psychrometric processes- adiabatic mixing- sensible heating and cooling- humidifying and dehumidifying, air washer – bypass factor- sensible heat factor-RSHF and GSHF line- Design condition- Apparent dew point temperature – Numerical examples.	<b>3-1-0</b>
	Air conditioning- applications, Comfort air conditioning- factors affecting human comfort. Effective temperature – comfort chart. Unitary and central system comparison. Capacity determination-cooling load estimation. COP, EER, IEER, IPLV, star rating, specification of capacity TONs, HP, Numerical examples.	<b>3-1-0</b>

APJ ABDUL KALAM  
TECHNOLOGICAL  
UNIVERSITY

**SEMESTER VII**

**OPEN ELECTIVE**



CODE	COURSE NAME	CATEGORY	L	T	P	CREDIT
MET415	INTRODUCTION TO BUSINESS ANALYTICS	OEC	2	1	0	3

**Prerequisite:** Basic knowledge of information systems, statistics, and business environment

**Course Outcomes:** After the completion of the course the student will be able to

CO 1	Understand the fundamentals of business intelligence, analytics, and data science.
CO 2	Use real life data for effective decision making using statistical models.
CO 3	Understand the basic concepts of data warehousing and use of data mining techniques for business analytics.
CO 4	Describe text analytics and understand the need for text mining.
CO 5	Understand the essence of business performance management and business reporting.
CO 6	Explore emerging technologies, legal and ethical issues that may impact analytics and business intelligence.

#### Mapping of course outcomes with program outcomes

	PO 1	PO 2	PO 3	PO 4	PO 5	PO 6	PO 7	PO 8	PO 9	PO 10	PO 11	PO 12
CO 1	2	1	-	-	-	-	-	-	-	-	-	-
CO 2	2	2	1	3	2	-	-	-	-	-	-	-
CO 3	-	2	3	1	3	-	-	-	-	-	-	-
CO 4	-	-	2	2	2	1	-	-	-	-	-	-
CO 5	-	-	-	2	-	2	-	-	1	3	2	
CO 6	-	-	-	-	-	1	-	2	-	-	-	1

#### Assessment Pattern

Bloom's Category	Continuous Assessment Tests		End Semester Examination
	1	2	
Remember	20	20	20
Understand	20	20	50
Apply	10	10	20
Analyse	-	-	10
Evaluate	-	-	-
Create	-	-	-

**Mark distribution**

<b>Total Marks</b>	<b>CIE</b>	<b>ESE</b>	<b>ESE Duration</b>
150	50	100	3 hours

**Continuous Internal Evaluation Pattern:**

Attendance	: 10 marks
Continuous Assessment Test (2 numbers)	: 25 marks
Assignment/Quiz/Course project	: 15 marks

**End Semester Examination Pattern:** There will be two parts; Part A and Part B. Part A contain 10 questions with 2 questions from each module, having 3 marks for each question. Students should answer all questions. Part B contains 2 questions from each module of which student should answer any one. Each question can have maximum 2 sub-divisions and carry 14 marks.

**Course Level Assessment Questions:****CO 1 Understand the fundamentals of business intelligence, analytics and data science**

1. Differentiate between predictive analytics and prescriptive analytics.
2. What is online transaction processing system?
3. List and describe the major components of Business Intelligence.

**CO 2 Use real life data for effective decision making using statistical models**

1. What are the various measures of dispersion?
2. Write a short note on time series forecasting.
3. What is data pre-processing? Why is it required?

**CO 3 Understand the basic concepts of data warehousing and use of data mining techniques for business analytics**

1. What is a data warehouse?
2. Identify five specific applications of data mining and a few common characteristics.
3. List five software tools used for data mining applications.

**CO 4 Describe text analytics and understand the need for text mining**

1. Why is the popularity of text mining as an analytics tool increasing?
2. Explain the importance of text mining in academia.
3. What is web mining? List the applications of web mining

**CO 5 Understand the essence of business performance management and business reporting**

1. What are the various functions an effective business report fulfils?
2. What is a performance measurement system? How does it work?
3. Explain the role of business analytics in human resource management.

**CO 6 Explore emerging technologies, legal and ethical issues that may impact analytics and business intelligence.**

1. How does cloud computing affect Business Intelligence?
2. How does traditional analytics make use of location-based data?
3. List a few legal issues of analytics.

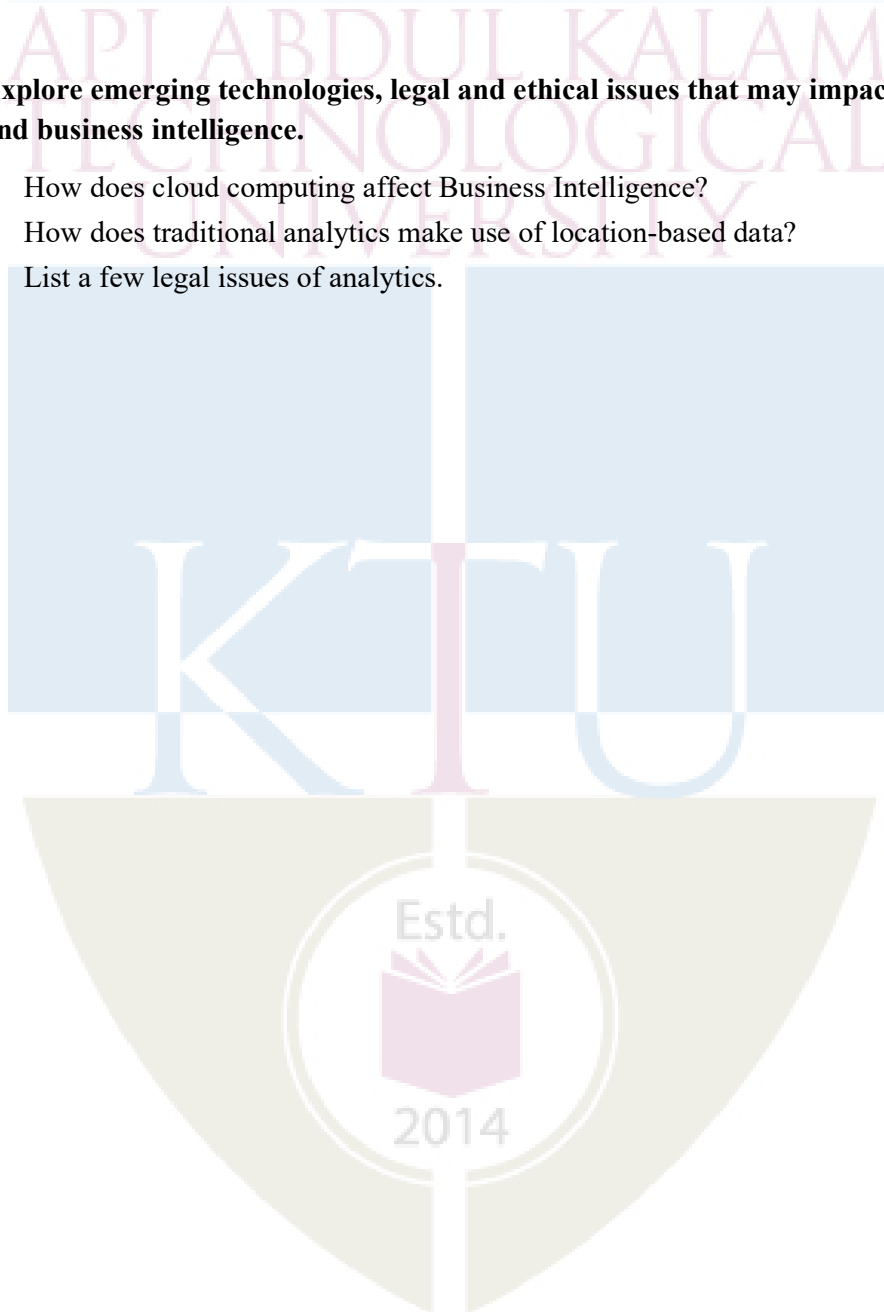

**Model Question Paper**

**APJ ABDUL KALAM TECHNOLOGICAL UNIVERSITY**  
**SEVENTH SEMESTER B.TECH DEGREE EXAMINATION**  
**MET415: INTRODUCTION TO BUSINESS ANALYTICS**

**Time:****3hours****Maximum marks: 100****PART-A (Answer all Questions)**

- 1 Define Business Intelligence. How will you relate it with Business Analytics?
- 2 What do you understand by the term Big Data?
- 3 What are the measures of central tendency?
- 4 Under what circumstances the use of inter-quartile range becomes essential?
- 5 How does a data warehouse differ from a transactional database?
- 6 Distinguish between text mining and web mining?
- 7 What are the distinguishing features of Key Performance Indicators?
- 8 What are the three components of a Business Performance System?
- 9 There are serious privacy concerns in analytics. Comment.
- 10 Name at least three major cloud service providers. **(3x10=30)**

**PART-B**

- 11 Detail at least seven key system-oriented trends that have fostered the growth of Business Intelligence based decision making. 14
- OR**
- 12 Explain the various levels of analytics 14
- 13 a What are the characteristics that define the readiness level of data for an analytic study? 9
- b Differentiate between structured and unstructured data. 5
- OR**
- 14 What is logistic regression? With a suitable example, explain the steps involved. 14
- 15 a What are the important steps in data mining? 9
- What are data lakes? Compare it with a data warehouse. 5
- OR**
- 16 a Write a short note on sentiment analysis 6
- b What is social media analytics? Explain its significance in business. 8
- 17 a What are the main differences among line, bar and pi charts? When should you use one over the others? 7
- b What is an information dashboards? Why are they so popular? 7

**OR**

- 18 List and briefly describe the four phases of Business Performance Management Cycle 1  
4
- 19 What are the major issues managers have to keep in mind while exploring IoT? 7  
What are the potential benefits of using geo-spatial data for analytics? Give 7  
examples.
- OR**
- 20 List a few ethical issues in analytics. 7  
Describe new organisational units that are created because of analytics 7



## Syllabus

<b>Module 1</b> (6 Hours)	<p><b>Introduction to Business Intelligence-</b> Definition, Need, and Evolution of Business Intelligence System and its components.</p> <p><b>Introduction to Business Analytics-</b> Definition- Levels of Analytics – Descriptive, Predictive and Prescriptive Analytics- Application of business analytics in industries- case studies.</p> <p><b>Transaction Processing and Analytic Processing-</b> Fundamentals of OLAP and OLTP</p> <p><b>Introduction to Big Data Analytics-</b> Characteristics- Sources of Big Data.</p>
<b>Module 2</b> (10 Hours)	<p><b>Data-</b> Definition- Sources of Data- Readiness Level of Data for Analytic study- Unstructured and structured data- classification of data- Data pre-processing- Steps in data pre-processing.</p> <p><b>Statistical Modelling for Business Analytics-</b> Descriptive Statistics- Measures of Central Tendency and Dispersion- Quartiles and inter-quartile range.</p> <p><b>Regression Modelling for Inferential Statistics-</b> Linear Regression, Logistic Regression and Time Series Forecasting.</p>
<b>Module 3</b> (8 Hours)	<p><b>Data Warehousing:</b> Characteristics- Design Considerations for data warehouse- Data warehousing process- Data Lakes.</p> <p><b>Data Mining:</b> Concepts - Data mining process- Applications- Software Tools.</p> <p><b>Text and Web Analytics:</b> Text analytics and text mining overview - Text mining applications - Sentiment Analysis- Web mining overview- Fundamentals of Social media analytics</p>
<b>Module 4</b> (6 Hours)	<p><b>Business Reporting-</b> Concepts- Different types of charts and graphs- Data Visualisation and Visual Analytics</p> <p><b>Business Performance Management:</b> Business performance management cycle- Performance Measurement System- Key Performance Indicators</p> <p><b>Analytics in Business Support Functions-</b> Sales &amp; Marketing, Human Resources, Financial Analytics, Production and operations analytics</p>
<b>Module 5</b> (5 Hours)	<p><b>Recent Trends, Privacy and Managerial Considerations in Analytics:</b> Use of Internet of Things for Business Analytics - Cloud Computing and Business Analytics- Location Based Analytics for Organisations - Issues of Legality, Privacy and Ethics- Impacts of Analytics in Organisations</p>

### Text Book

1.R. Sharda, D. Delen, and E. Turban, “Business Intelligence, Analytics, and Data Science: A Managerial Perspective”, Pearson, 4<sup>th</sup> edition, 2018.

### Reference Books

- 1.R. N. Prasad and S. Acharya, “Fundamentals of Business Analytics”, Wiley, 2<sup>nd</sup> Edition, 2016
- 2.J. R. Evans, “Business Analytics”, Pearson, 3<sup>rd</sup> Edition, 2019.
3. A. Maheshwari, “Data Analytics”, McGraw Hill Education, 1<sup>st</sup> Edition, 2017

4. Business Analytics for Managers: Taking Business Intelligence Beyond Reporting, 2nd Edition, Wiley, 2016

### Course Contents and Lecture Schedule

No	Topic	Hours
<b>Module 1 (6 Hours)</b>		
1.1	Introduction to Business Intelligence- Definition, Need, and Evolution of Business Intelligence System and its components	1
1.2	Introduction to Business Analytics- Definition- Levels of Analytics	1
1.3	Descriptive, Predictive and Prescriptive Analytics	1
1.4	Application of business analytics in industries- case studies	1
1.5	Transaction Processing and Analytic Processing- Fundamentals of OLAP and OLTP	1
1.6	Introduction to Big Data Analytics- Characteristics- Sources of Big Data	1
<b>Module II (10 Hours)</b>		
2.1	Data- Definition- Sources of Data- Readiness Level- Unstructured and structured data	1
2.2	Classification of data- Data Pre-processing- Steps in data pre-processing	1
2.3	Statistical Modelling for Business Analytics- Descriptive Statistics- Measures of Central Tendency and Dispersion	2
2.4	Quartiles and inter-quartile range.	1
2.5	Regression Modelling for Inferential Statistics- Linear Regression.	2
2.6	Logistic Regression	2
2.7	Time Series Forecasting	1
<b>Module III (8 Hours)</b>		
3.1	Data Warehousing: Characteristics- Design Considerations for data warehouse- Data warehousing process- Data Lakes	2
3.2	Data Mining: Concepts - Data mining process	1
3.3	Applications of Data Mining	1
3.4	Software Tools	1
3.5	Text & Web Analytics: Text analytics and text mining overview	1
3.6	Text mining applications- Sentiment Analysis	1
3.7	Web mining overview- Fundamentals of Social media analytics	1
<b>Module IV (6 Hours)</b>		
4.1	Business Reporting- Concepts- Different types of charts and graphs-	1
4.2	Data Visualisation and Visual Analytics	1
4.3	Business Performance Management: Business performance management cycle-	1
4.4	Performance Measurement System- Key Performance Indicators	1

4.5	Analytics in Business Support Functions- Sales & Marketing, Human Resources, Financial Analytics, Production and operations analytics	2
<b>Module V (5 Hours)</b>		
5.1	Use of Internet of Things for Business Analytics - Cloud Computing and Business Analytics	2
5.2	Location Based Analytics for Organisations	1
5.3	Issues of Legality, Privacy and Ethics	1
5.4	Impacts of Analytics in Organisations	1

ABDUL KALAM  
TECHNOLOGICAL  
UNIVERSITY



CODE	COURSE NAME	CATEGORY	L	T	P	CREDIT
MET425	QUANTITATIVE TECHNIQUES FOR ENGINEERS	OEC	2	1	0	3

**Preamble:** This course is designed to facilitate the students to acquire knowledge about quantitative techniques for engineers. This course covers linear programming, transportation problem, assignment problem, sequencing problem, network analysis, decision theory, game theory, queuing theory and simulation. It empowers the students to amalgamate their knowledge and thus inculcate the skills needed to apply these techniques in industry.

**Prerequisite:** Nil

**Course Outcomes:** After the completion of the course the student will be able to

CO 1	Solve problems using linear programming methods.
CO 2	Solve transportation problems and assignment problems.
CO 3	Solve sequencing problems and perform network analysis.
CO 4	Apply decision theory and game theory.
CO 5	Apply queuing theory and perform simulation for queuing problems.

#### Mapping of Course Outcomes with Program Outcomes

	PO 1	PO 2	PO 3	PO 4	PO 5	PO 6	PO 7	PO 8	PO 9	PO 10	PO 11	PO 12
CO 1	3	3	2	1	2					1	2	2
CO 2	3	3	2	1	2					1	2	2
CO 3	3	3	2	1	2					1	3	2
CO 4	3	3	2	1	2					1	2	2
CO 5	3	3	2	1	2					1	2	2

#### Assessment Pattern

Bloom's Category	Continuous Assessment Tests		End Semester Examination
	1	2	
Remember	10	10	10
Understand	10	10	20
Apply	30	30	70
Analyse			
Evaluate			
Create			

#### Mark Distribution

Total Marks	CIE	ESE	ESE Duration
150	50	100	3 hours

**Continuous Internal Evaluation Pattern:**

Attendance	: 10 marks
Continuous Assessment Test (2 numbers)	: 25 marks
Assignment/Quiz/Course Project	: 15 marks

**End Semester Examination Pattern:** There will be two parts; Part A and Part B. Part A contain 10 questions with 2 questions from each module, having 3 marks for each question. Students should answer all questions. Part B contains 2 questions from each module of which student should answer any one. Each question can have maximum 2 sub-divisions and carry 14 marks.

**Course Level Assessment Questions****Course Outcome 1 (CO1):**

1. Demonstrate the applications of quantitative techniques.
2. Formulate mathematical model for the given problem.
3. Apply linear programming methods to get the optimum solution.

**Course Outcome 2 (CO2):**

1. Identify the applications of transportation problems and assignment problems.
2. Solve transportation problem to get the initial feasible solution or optimum solution.
3. Solve assignment problem in order to minimize the total cost.

**Course Outcome 3 (CO3):**

1. Demonstrate assumptions of sequencing problems.
2. Determine the optimal sequence of operations.
3. Construct project network diagram and perform network analysis.

**Course Outcome 4 (CO4):**

1. Compare various decision making conditions.
2. Determine the optimal decision based on the given criterion.
3. Determine the optimal strategies and value of the game.

**Course Outcome 5 (CO5):**

1. Illustrate the concept of simulation.
2. Demonstrate Monte Carlo simulation for a queuing system.
3. Determine the parameters of the queuing system.

**Model Question Paper**

**APJ ABDUL KALAM TECHNOLOGICAL UNIVERSITY**  
**SEVENTH SEMESTER B. TECH DEGREE EXAMINATION**  
**Course Code: MET425**

**Course Name: QUANTITATIVE TECHNIQUES FOR ENGINEERS**

**Max. Marks: 100**  
**Hours**

**Duration: 3**

**PART A**

**(ANSWER ALL QUESTIONS, EACH QUESTION CARRIES 3 MARKS)**

1. Discuss the applications of quantitative techniques.
2. Explain alternate optimum solution, unbounded solution and infeasible solution.
3. What are the applications of transportation problem?
4. Explain the similarity between transportation problem and assignment problem.
5. What are the assumptions in sequencing problem?
6. What is crashing of project network?
7. Differentiate between decision under certainty and decision under risk.
8. Explain players, strategy and saddle point of game theory.
9. Define simulation and its advantages.
10. Discuss the steps of Monte Carlo simulation.

**PART B**

**(ANSWER ONE FULL QUESTION FROM EACH MODULE, EACH QUESTION CARRIES 14 MARKS)**

**MODULE 1**

11. Solve the following LP problem using simplex method.

$$\text{Maximize } Z = 3X_1 + 5X_2$$

Subject to

$$X_1 + X_2 \leq 4$$

$$3X_1 + 2X_2 \leq 18$$

$$X_1 \text{ and } X_2 \geq 0$$

12. A company produces 2 types of hats A and B. Every hat A requires twice as much labour time as the second hat B. If the company produces only hat B then it can produce a total of 500 hats per day. The market limits daily sales of hat A and B to 150 and 250 respectively. The profit on hat A and B are Rs. 8 and Rs. 5 respectively. Solve graphically to get the optimum solution.

**MODULE 2**

13. Obtain the initial basic feasible solution for the following transportation problem using (a) North west corner rule (b) Least cost cell method (c) Vogel's approximation method

	Warehouses				
Plants		X	Y	Z	Supply
	A		8	7	3

	B	3	8	9	70
	C	11	3	5	80
	Demand	50	80	80	

State which of the methods is better

14. Solve the following assignment problem in order to minimize the total cost. The costs of doing different jobs by different operators are given below.

Job	Operator				
	1	2	3	4	5
1	5	6	8	6	4
2	4	8	7	7	5
3	7	7	4	5	4
4	6	5	6	7	5
5	4	7	8	6	8

### MODULE 3

15. Find an optimal sequence for processing five jobs through four machines in the order A-B-C-D-E. Find the total minimum elapsed time if no passing of jobs is permitted. Also find idle time on each machine.

Jobs	Machines				
	A	B	C	D	E
1	9	7	5	4	11
2	8	8	6	7	12
3	7	6	7	8	10
4	10	5	5	4	8

16. Consider the data of a project summarized in the following table.

Activity	Immediate Predecessor(s)	Duration (weeks)		
		a	m	b
A	-	3	5	8
B	-	6	7	9
C	A	4	5	9
D	B	3	5	8
E	A	4	6	9
F	C, D	5	8	11
G	C, D, E	3	6	9
H	F	1	2	9

- Construct the project network
- Find the expected duration and variance of each activity
- Find the critical path and expected project completion time.
- What is the probability of completing the project on or before 35 weeks?

**MODULE 4**

17. Consider the following cost matrix and determine the best order size using the minimax criterion.

		Demand ( $D_j$ )				
		50	100	150	200	250
Order Size ( $Q_i$ )	75	950	1200	575	-675	-1425
	150	50	1700	2000	2250	1600
	225	-850	850	2550	3550	4525
	300	-1800	600	1800	2000	5000

Also obtain best order size based on the Hurwicz criterion ( $\alpha = 0.5$ ).

18. Solve the following pay-off matrix. Also determine the optimal strategies and value of the game.

		A	
		1	2
B	1	10	8
	2	6	12

**MODULE 5**

19. A weighing station has single weighing bridge. The arrival rate of the vehicles coming to the weighing station follows Poisson distribution and it is 45 vehicles per hour. The service rate also follows Poisson distribution and it is 55 vehicles per hour. In front of the weighing bridge, the waiting space is sufficient for a maximum of 10 vehicles. Find the following;

- Average waiting number of vehicles in the queue in front of the weighing bridge as well as in the weighing station.
- Average waiting time per vehicle in front of the weighing bridge as well as in the weighing station.

20. The arrival rate of customers at a banking counter follows Poisson distribution with a mean of 30 per hour. The service rate of the counter clerk also follows Poisson distribution with a mean of 45 per hour.

- What is the probability of having 0 customer in the system?
- What is the probability of having 12 customers in the system?
- Find  $L_s$ ,  $L_q$ ,  $W_s$  and  $W_q$ .

## Syllabus

### Module 1

Introduction to quantitative techniques – basics of operations research – applications. Linear programming – problem formulation – graphical method – simplex method – big-m method – two-phase method – duality in linear programming. (7 hours)

### Module 2

Transportation problem – formulation – balanced & unbalanced transportation problems – north west corner rule – least cost method – Vogel's approximation method – stepping stone method. Assignment problem – formulation – optimal solution – Hungarian algorithm – variants of assignment problems. (7 hours)

### Module 3

Sequencing problem – terminology and notations – assumptions – problems with n jobs through two machines – problems with n jobs through three machines – problems with n jobs through m machines. Network analysis – basic terms – network construction – time analysis – critical path method (CPM) – programme evaluation and review technique (PERT) – cost considerations in network analysis – crashing. (7 hours)

### Module 4

Decision theory – steps in decision theory approach – decision making conditions – decisions under conditions of risk – decisions under uncertainty conditions – decision tree analysis. Game theory – games with saddle points – games without saddle points – 2 x 2 games – graphical method for m x 2 & 2 x n games. (7 hours)

### Module 5

Introduction to queuing theory – terminologies – classification of queuing models – single server problems – multi server problems. Simulation – generation of random numbers – Monte Carlo simulation – queuing simulation model. (7 hours)

### Text Books

1. Paneerselvam, R., Operations Research, Prentice Hall of India, New Delhi, 2017.
2. Taha, H. A., Operations Research: An Introduction, Pearson, 2013.

### Reference Books

1. Miller, D. M. and Schmidt, J. W., Industrial Engineering and Operations Research, John Wiley & Sons, Signapore, 1990.
2. Goel, B. S. and Mittal, S. K., Operations Research, Pragati Prakashan, Meerut, 1999.
3. Banks, J., Carson, J. S., Nelson, B. L., and Nicol, D. M., Discrete-Event System Simulation, Third Edition, Pearson Education, Inc., 2001.

**Course Contents and Lecture Schedule**

No	Topic	No. of Lectures
1	<b>Module 1</b>	
1.1	Introduction to quantitative techniques – basics of operations research – applications.	1
1.2	Linear programming – problem formulation – graphical method.	2
1.3	simplex method – big-m method – two-phase method – duality in linear programming.	4
2	<b>Module 2</b>	
2.1	Transportation problem – formulation – balanced & unbalanced transportation problems – north west corner rule – least cost method	2
2.2	Vogel's method – stepping stone method.	2
2.3	Assignment problem – formulation – optimal solution – Hungarian algorithm – variants of assignment problems.	3
3	<b>Module 3</b>	
3.1	Sequencing problem – terminology and notations – assumptions – problems with n jobs through two machines – problems with n jobs through three machines – problems with n jobs through m machines.	2
3.2	Network analysis – basic terms – network construction – time analysis – critical path method (CPM).	2
3.3	Programme evaluation and review technique (PERT) – cost considerations in network analysis – crashing.	3
4	<b>Module 4</b>	
4.1	Decision theory – steps in decision theory approach – decision making conditions – decisions under conditions of risk.	2
4.2	Decisions under uncertainty conditions – decision tree analysis.	2
4.3	Game theory – games with saddle points – games without saddle points – 2 x 2 games – graphical method for m x 2 & 2 x n games.	3
5	<b>Module 5</b>	
5.1	Introduction to queuing theory – terminologies – classification of queuing models – single server problems.	3
5.2	Multi server problems.	3
5.3	Simulation – generation of random numbers – Monte Carlo simulation – queuing simulation model.	2

CODE	COURSE NAME	CATEGORY	L	T	P	CREDIT
MET435	AUTOMOTIVE TECHNOLOGY	OEC	2	1	0	3

**Preamble:** The objective of this course is

- To know the anatomy of automobile in general
- To understand the working of different automotive systems and subsystems
- To update the latest developments in automobiles

**Prerequisite:** EST 120 Basics of Mechanical Engineering

**Course Outcomes:** After the completion of the course the student will be able to

CO 1	Explain different automotive systems and subsystems .
CO 2	Illustrate the working of transmission, suspension, steering and braking systems of an automobile.
CO 3	Summarize the basic technology in electric vehicles.
CO 4	Explain the various safety, security and comfort systems in automotive technology.

**Mapping of course outcomes with program outcomes**

	PO 1	PO 2	PO 3	PO 4	PO 5	PO 6	PO 7	PO 8	PO 9	PO 10	PO 11	PO 12
CO 1	✓											✓
CO 2	✓											✓
CO 3	✓											✓
CO 4	✓											✓

**Assessment Pattern**

Bloom's Category	Continuous Assessment Tests		End Semester Examination
	1	2	
Remember			
Understand	50	50	100
Apply			
Analyse			
Evaluate			
Create			

**Mark distribution**

Total Marks	CIE	ESE	ESE Duration
150	50	100	3 hours

**Continuous Internal Evaluation Pattern:**

Attendance	: 10 marks
Continuous Assessment Test (2 numbers)	: 25 marks
Assignment/Quiz/Course project	: 15 marks

**End Semester Examination Pattern:** There will be two parts; Part A and Part B. Part A contain 10 questions with 2 questions from each module, having 3 marks for each question. Students should answer all questions. Part B contains 2 questions from each module of which student should answer any one. Each question can have maximum 2 sub-divisions and carry 14 marks.

**Course Level Assessment Questions****Course Outcome 1 (CO1):**

1. Explain the injection system in an SI engine.
2. Differentiate between MPFI and CRDI.
3. Describe an automobile engine layout and its components.

**Course Outcome 2 (CO2)**

1. Explain Ackermann steering mechanism with a neat sketch.
2. Explain in detail the working and function of ABS braking system.
3. Describe the need of clutch and gearbox in an automobile?

**Course Outcome 3 (CO3):**

1. What is the difference between an electric vehicle and a hybrid vehicle?
2. List out the differences in the chassis design of an electric vehicle comparing with the conventional chassis.
3. Explain the basic operation of a fuel cell.

**Course Outcome 4 (CO4):**

1. Explain the various safety features employed in automotive technology?
2. Explain the air conditioning system in an automobile.
3. Describe the functions of electro-mechanical and electronic immobilizers in the security of an automobile?

**Model Question Paper**

Max. Marks: 100

Duration: 3 Hours

**PART A (30 marks)***Answer all questions, each carries 3 marks.*

1. Explain turbocharger lag and the methods to reduce it.
2. Identify the difference between SI and CI engine.
3. Describe automated manual transmission.
4. Explain the principle of dry friction clutch.
5. Compare between drum and disc brakes.
6. Summarize the features of hydro pneumatic suspension system .
7. Indicate the advantage of EV over conventional IC engines.
8. Explain Ackermann principle in steering mechanism system.
9. Explain the working of remote keyless entry in a vehicle.
10. Describe the child lock safety system.

**PART B (70 marks)***Answer any one question from each module, each carries 14 marks.***Module 1**

11. a) Distinguish between MPFI and CRDI systems. (6)
- b) Explain the working and advantages of turbocharger with a neat sketch (8)
12. Explain the fuel supply system, injection system and ignition system in an SI engine. (14)

**Module 2**

13. a) Discuss the working of Pull type diaphragm clutch with a neat sketch. (8)
- b) Cite the principle of operation of an electromagnetic clutch . (6)

14. a) Explain the need of a gear box and the common troubles encountered in gear boxes along with suitable remedies . (8)
- b) Describe the working of an epicyclic gear box. (6)

### *Module 3*

15. a) Represent the features of McPherson strut suspension system with a neat sketch. (8)
- b) Explain the function of an antiroll bar in a four wheeled vehicle . (6)
16. a) Discuss the working and advantages of ABS over conventional systems. (8)
- b) Explain the properties of friction lining and pad materials (6)

### *Module 4*

17. a) Differentiate between over steering and under steering. (8)
- b) Illustrate the rack and pinion steering gear box system. (6)
18. a) Explain the basic principle of a hydrogen fuel cell and its efficiency. (8)
- b) Indicate different type of batteries used in an electric vehicle. (6)

### *Module 5*

19. a) Explain the air conditioning system in an automobile. (8)
- b) Discuss the methods to control the aerodynamic lift in vehicles. (6)
20. a) Classify active and passive safety systems in a car. (8)
- b) Explain how an electronic immobilizer can prevent the vehicle theft. (6)

## Syllabus

### Module 1 (7 hours)

Automobile system layout- Engine and its components, SI and CI engine, working principle, Fuel supply and injection system-comparison, multiport fuel injection (MPFI) and common rail direct injection (CRDI) systems. Ignition system, Engine emission and standards.

Super charging systems: fundamentals, naturally aspirated engines and supercharged engines– Turbo charger, turbo lag

### Module 2 (7 hours)

Friction clutch: Principle, dry friction clutches- Pull type diaphragm clutch, multiple diaphragm clutch, multi-plate hydraulically operated automatic transmission clutch, semi centrifugal clutch, fully automatic centrifugal clutch, and integral single plate diaphragm clutch. Electromagnetic clutch operation. wet clutch, clutch friction materials, fluid friction coupling.

Manual transmission- Need of gear box, power to weight ratio, speed operating range-five speed and reverse sliding mesh, constant mesh, and synchromesh gear boxes. Automatic transmission- Epicyclic gear box - torque convertor – Over drives. Automated manual transmission.

### Module 3 (7 hours)

Suspension system: - Types of suspension springs, suspension geometry and terminology, types of suspension systems, independent suspension, Antiroll bar, Hydrogen suspension, hydro pneumatic suspension, suspension roll center and body roll.

Brakes: Principle of brake, classification of brakes-mechanical and hydraulic brakes- Drum and Disc brakes, properties of friction lining and pad materials, Anti-Lock Braking system (ABS), principle of operation and types of ABS.

### Module 4 (7 hours)

Steering: -basic principle of a steering system– Ackermann –over steer and under steer – Steering geometry -slip angle, camber, king pin inclination, caster, toe-in and toe-out. Steering gear box–types- need of power assisted steering.

Electric Vehicle Technology (EVT): EV Architecture, types of batteries, battery parameters, super capacitors. Fuel cells and its efficiency. EV Chassis – requirements, suspension for EVs. Recent Electric vehicles- Electric mobility aids. Future of electric vehicles –Tesla S, Maglev trains, Electric rail road systems.

### Module 5 (7 hours)

Safety-Active and passive safety, air bags, seat belt tightening system, forward collision warning system, child lock, advanced safety systems.

Comfort system –Automotive air-conditioning, aerodynamics lift and drag reduction, adaptive cruise control, tilt-able steering column and power window and advanced comfort system.

Security system -Anti theft technology-mechanical, electromechanical and electronic immobilizers, alarm system and remote keyless entry.

### Text Books

1. Heinz Heisler, Vehicle and engine technology, Butterworth-Heinemann, 2<sup>nd</sup> edition, 1998.
2. R.B. Gupta., Auto design , Satya Prakashan Publishers, New Delhi, 2016 .
3. James Larminie and John Lowry, Electric vehicle technology explained, Wiley publications, 2<sup>nd</sup> edition, 2015.
4. Kirpal Singh, Automobile Engineering Vol.1 & Vol.2, Standard Publishers, 13<sup>th</sup> edition, 2020.

### Reference Books

- 1.V.A.W. Hillier, Fundamentals of modern vehicle technology, Butterworth-Heinemann, 2nd edition, 1998.
- 2.Tom Denton, Electric and Hybrid Vehicles, Routledge Publishers, 2nd edition, 2020.
- 3.Ljubo Vlacic, Michel Parent and Fumio Harashima, Intelligent vehicle technologies, Butterworth-Heinemann publications, Oxford 2001.
- 4.ShimoKim and Rakesh Shresta, Automotive Cyber Security: Introduction Challenges and Standardization, Springer, Singapore, 1st edition. 2020.

### Course Contents and Lecture Schedule

No	Topic	No. of Lectures
<b>1</b>	<b>Automobile system layout</b>	
1.1	Engine and its components- IC engines, piston, rings, pin, flywheel, connecting rod.	1
1.2	SI and CI engine, working principle	1
1.3	Fuel supply and injection system-comparison	1
1.4	MPFI and CRDI systems	1
1.5	Ignition system	1
1.6	Engine emission and standards	1
1.7	Super charging systems	1
<b>2</b>	<b>Clutch and transmission</b>	
2.1	Principle of dry friction clutches- Single plate clutch, Multi plate hydraulically operated automatic transmission clutch.	1
2.2	Semi centrifugal clutch, fully automatic centrifugal clutch	1
2.3	Integral single plate diaphragm clutch, Electromagnetic clutch	1

	operation.	
2.4	Clutch friction materials, wet clutches, fluid friction coupling.	1
2.5	Need of gear box, power to weight ratio, speed operating range .Sliding mesh, constant mesh and synchromesh gear boxes.	1
2.6	Epicyclic gear box, Torque convertor	1
2.7	Over drives, Automated manual transmission.	1
<b>3</b>	<b>Suspension and brake</b>	
3.1	Suspension system: - Types of suspension springs, suspension geometry and terminology.	1
3.2	Types of suspension systems ,independent suspension.	1
3.3	Antiroll bar, Hydrogen suspension, hydro pneumatic suspension.	1
3.4	Suspension roll center and body roll.	1
3.5	Brakes: Principle of brake, classification of brakes, mechanical and hydraulic brakes.	1
3.6	Drum and Disc brakes, properties of friction lining and pad materials	1
3.7	Anti-Lock Braking system (ABS), principle of operation and types of ABS.	1
<b>4</b>	<b>Steering and Electric vehicle technology</b>	
4.1	Ackermann steering mechanism, over steer and under steer .	1
4.2	Steering geometry -slip angle, camber, king pin inclination, caster, toe-in and toe-out.	1
4.3	Steering gear box, Types of steering gear box, need of power assisted steering.	1
4.4	EV Architecture, types of batteries, battery parameters, super capacitors. Fuel cells and its efficiency.	1
4.5	Super capacitors. Fuel cells and its efficiency.	1
4.6	EV Chassis – requirements, suspension for EVs. Recent Electric vehicles- Electric mobility aids.	1
4.7	Future of electric vehicles –Tesla S, Maglev trains, Electric rail road systems.	1

<b>5</b>	<b>Safety, control and security in automotive technology</b>	
5.1	Safety-Active and passive safety, air bags, seat belt tightening system,	1
5.2	Forward collision warning system, child lock antilock braking system	1
5.3	Comfort system - Automotive air-conditioning, aerodynamics lift and drag reduction,	1
5.4	Adaptive cruise control, tilt-able steering column, power window and advanced comfort system	2
5.5	Anti-theft technology-mechanical, electromechanical and electronic immobilizers.	1
5.6	Alarm system and remote keyless entry.	1

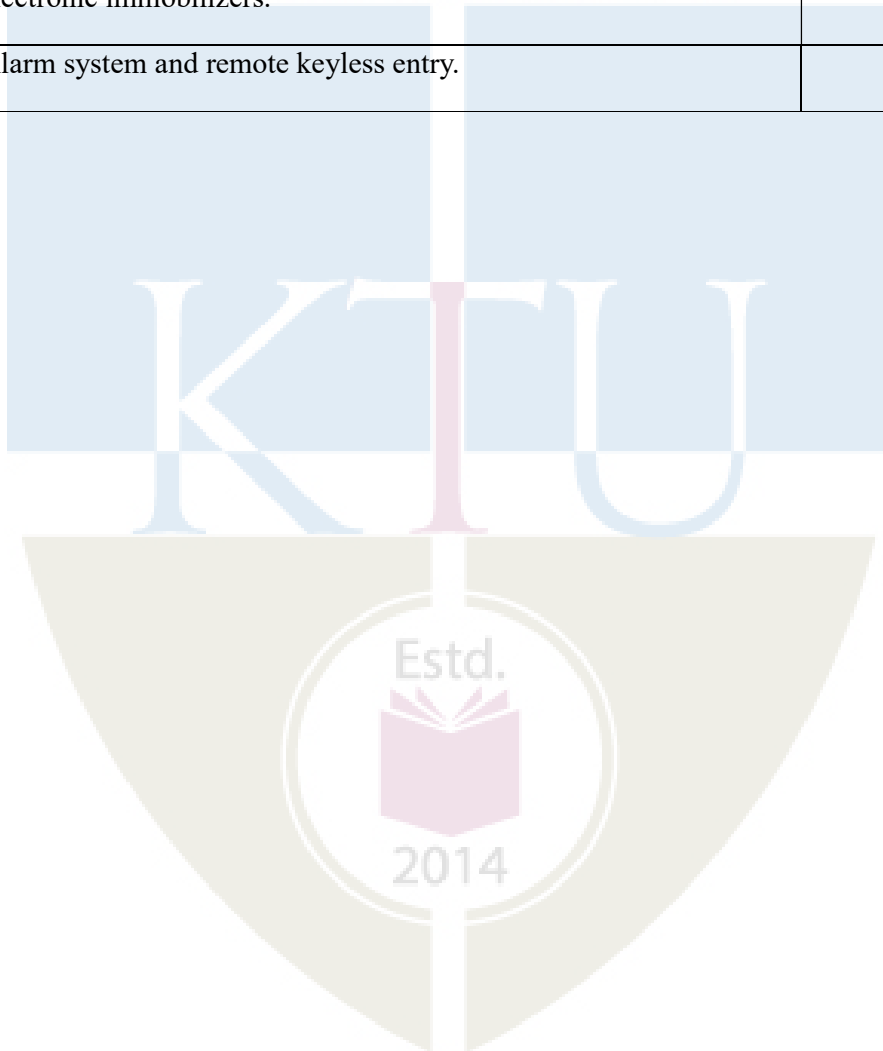

CODE	COURSE NAME	CATEGORY	L	T	P	CREDIT
MET445	RENEWABLE ENERGY ENGINEERING	OEC	2	1	0	3

**Preamble:** The course is intended to give knowledge of various renewable energy sources, systems and applications and the need in the present context. Students will be able to compare different renewable energy techniques and choose the most appropriate based on local conditions. To equip students in working with projects and to take up research work in connected areas.

**Prerequisite:** Nil

**Course Outcomes:** After completion of the course the student will be able to

CO1	Explain renewable energy sources and evaluate the implication of renewable energy. To predict solar radiation at a location
CO2	Explain solar energy collectors, storages, solar cell characteristics and applications
CO3	Explain the different types of wind power machines and control strategies of wind turbines
CO4	Explain the ocean energy and conversion devices and different Geothermal sources
CO5	Explain biomass energy conversion devices. Calculate the Net Present value and payback period

**Mapping of course outcomes with program outcomes**

	PO 1	PO 2	PO 3	PO 4	PO 5	PO 6	PO 7	PO 8	PO 9	PO 10	PO 11	PO 12
CO 1	3											3
CO 2	3	3			1	1	1				1	3
CO 3	3	3			1	1	1				1	3
CO 4	3	3			1	1	1				1	3
CO 5	3	3			1	1	1				1	3

**Assessment Pattern**

Bloom's Category	Continuous Assessment Tests		End Semester Examination
	1	2	
Remember	10	10	10
Understand	20	20	20
Apply	20	20	70
Analyse			
Evaluate			
Create			

**Mark distribution**

Total Marks	CIE	ESE	ESE Duration
150	50	100	3 hours

**Continuous Internal Evaluation Pattern:**

Attendance	: 10 marks
Continuous Assessment Test (2 numbers)	: 25 marks
Assignment/Quiz/Course project	: 15 marks

**End Semester Examination Pattern:** There will be two parts; Part A and Part B. Part A contain 10 questions with 2 questions from each module, having 3 marks for each question. Students should answer all questions. Part B contains 2 questions from each module of which student should answer any one. Each question can have maximum 2 sub-divisions and carry 14 marks.

**Course Level Assessment Questions:****Course Outcome 1 (CO1):**

1. What are the main renewable energy sources? Advantages and limitations
2. What is energy efficiency? How is it different from renewable energy use?
3. Define terms : Angle of Incidence, Declination, Solar constant

**Course Outcome 2 (CO2):**

1. Discuss different types of solar collectors
2. Discuss about different types of thermal storage devices
3. Draw the I-V characteristics of Solar cell under varying temperature and irradiation level

**Course Outcome 3 (CO3):**

1. Types of wind turbine and components
2. Difference between wind mill and wind turbine
3. Explain importance of drag and lift force in wind power generation.

**Course Outcome 4 (CO4):**

1. Explain with neat sketch the working of hybrid OTEC system
2. Explain with neat sketch the vapour dominated geothermal system

**Course Outcome 5 (CO5):**

1. Distinguish between Fixed dome plant and floating dome type biomass plant.
2. Write a short note on solar saving.
3. Derive expression for payback period

**Model Question Paper****MODEL QUESTION PAPER****APJ ABDUL KALAM TECHNOLOGICAL UNIVERSITY****VII SEMESTER B.TECH DEGREE EXAMINATION****MET445 RENEWABLE ENERGY ENGINEERING****Maximum: 100 Marks****Duration: 3 hours****PART A**

Answer all questions, each question carries 3 marks

1. Discuss in brief advantages of renewable energy.
2. Explain the following terms related to solar geometry (i) Hour Angle ((ii) Zenith Angle (iii) Surface azimuth angle
3. List different types of solar collectors
4. Discuss about solar pond
5. List the different methods used to estimate wind speed at a location.
6. What are the advantages of wind energy conversion systems?
7. List the geothermal resources.
8. Discuss advantages and disadvantages of a tidal power plant
9. Name the different processes used for hydrogen production
10. List the need for economic analysis of renewable energy system.

(10 X 3 = 30 marks)

**PART B****Answer one full question from each module****Module 1**

11. Elucidate the necessity of energy storage in the context of renewable sources of energy (14 Marks )
12. (a) Calculate the number of daylight hours in Srinagar for 22nd June .The latitude of Srinagar as 34°05'N. (4 Marks)
- (b) Compare the construction and working of Pyranometer and Pyrheliometer. (10 Marks)

**Module 2**

13. (a) How solar thermal power plants classified. List the methods for converting solar energy into electric power (10 Marks)
- (b) Briefly explain the applications of a solar PV system.. (4 Marks)
14. (a) Draw and explain the operation of flat plate collectors. (10 Marks)
- (b) Explain the thermal methods of energy storage (4 Marks)

**Module 3**

15. With a neat diagram explain the construction of a propeller type wind power system (14 marks)
16. (a) Derive the expression for power in the wind turbine. (7 marks)
- b) Explain control mechanism in wind turbines (7 marks)

**Module 4**

17. State the principle of Ocean Thermal Energy Conversion (OTEC). Explain working of closed cycle OTEC system. (14 marks)
18. . Explain binary cycle Geothermal system (14 marks)

**Module 5**

19. Explain the construction and working of KVIC (floating type) bio gas plant (14 marks)
20. a. Define (1) Payback time (2) Return on investment . (6 marks)
- (3) Life cycle cost
- b. A solar PV system consisting with two lamps, a battery and other associated components cost Rs. 55000. The cost of conventional energy saved due to its installation is Rs. 4000 in the first year and this cost inflates at the rate of 5 % per year. Assume discounting rate is 9%. Calculate the payback period of the system with and without discounting (8 marks)

**Syllabus****Module 1**

**The Energy Scenario-** Commercial energy sources -World's production and reserves-India' Production and reserves, Energy Alternatives, Need for alternatives –solar option-nuclear options

**Principles of solar radiation :** Solar radiation outside the earth's atmosphere and at the earth's surface , Solar Constant, Basic Sun-Earth Angles, Instruments for measuring solar radiation and sunshine , Solar radiation data

**Module 2**

Solar Energy collectors: Solar thermal collectors -Flat plate collectors –Solar concentrators (parabolic trough, parabolic dish, Central Tower Collector) –Solar Air Heaters

Solar thermal electric power generation -Thermal Energy storage, sensible heat storage, latent heat storage , Thermo chemical storage , photovoltaic system for power generation , Solar pond -Solar Cells-Types of solar cells , principle of working and performance characteristics, Production process- Block diagram only

Applications- Solar space heating and cooling of buildings, solar pumping, solar cooker, solar still, solar drier, solar refrigeration and air-conditioning, heliostat, solar furnace

**Module 3**

**Wind Energy-** classification of wind turbines and power performance curve, Energy in wind, calculation of energy content, Power coefficients, Betz limit theory, , tip speed ratio, solidity of turbine' power control strategies, Basic principles of Wind Energy Conversion Systems (WECS), Classification of WECS, Parts of WECS

**Module 4**

**Ocean Energy** – Devices for Wave Energy conversion, Ocean Thermal Energy Conversion (OTEC): Principle of OTEC system, Methods of OTEC power generation – Open Cycle (Claude cycle), Closed Cycle (Anderson cycle) and Hybrid cycle (block diagram description of OTEC); Geothermal energy: Introduction, hot dry rock resources, magma resources, vapor and liquid dominated systems, binary cycle, advantages and disadvantages

**Module 5**

**Bio Mass Energy-** Biomass conversion technologies –Bio Gasification, Bio ethanol, Bio Diesel , Biogas production from waste biomass, factors affecting biogas generation Bio Gas -KVIC and Janata model ,Hydrogen Energy – various routes for production of Hydrogen energy,

**Economic Analysis** – Initial and annual cost, basic definitions, present worth calculations, repayment of loan in equal annual installments, annual savings, cumulative saving and life cycle cost, economic analysis of add on solar system, payback period(derivation)

**Text Books:**

1. S P Sukhatme , J K Nayak, Solar Energy: Principles of Thermal Collection and Storage, Mc Graw Hill ,2015
2. Tiwari G N, Ghosal M K ,Fundamentals of renewable energy sources, Alpha Science International Ltd.,2007
3. Jefferson W Tester et.a., Sustainable Energy Choosing among options,PHI,2006

**Reference Books:**

1. D.P. Kothari Renewable energy resources and emerging technologies, Prentice Hall of India Pvt. Ltd,2011
2. Mehmet KanoğluYunus A. Çengel John M. Cimbala , Fundamentals and Applications of Renewable Energy, Mc Graw Hill ,2019
3. Roland Wengenmayr, Thomas Buhrke, 'Renewable Energy: Sustainable energy concepts for the future, Wiley – VCH, 2012

**Course Contents and Lecture Schedule**

No.	Topic	No. of Lectures
1	<b>The Energy Scenario</b>	<b>(5)</b>
1.1	Commercial energy sources -World's production and reserves India' Production and reserves	1
1.2	,Energy Alternatives- Need for alternatives –solar options	1
	<b>Principles of solar radiation</b>	
1.3	Solar radiation outside the earth's atmosphere and at the earth's surface , Solar Constant,	1
1.4	Basic Sun-Earth Angles, Instruments for measuring solar radiation and sunshine , Solar radiation data	2
2	<b>Solar Energy</b>	<b>(11)</b>
2.3	Solar thermal collectors -Flat plate collectors	2
2.4	Solar concentrators (parabolic trough, parabolic dish, Central Tower Collector	2
2.5	Solar Air Heaters-types - Solar thermal electric power generation Thermal Energy storage, sensible heat storage, latent heat storage , Thermo chemical storage	2
2.7	Photovoltaic system for power generation	2
2.8	Solar Cells-Types of solar cells , principle of working and performance characteristics, Production process- Block diagram only	2
2.9	Applications- Solar space heating and cooling of buildings, solar pumping, solar cooker, solar still, solar drier, solar refrigeration and air-conditioning, heliostat, solar furnace	1
3	<b>Wind Energy</b>	<b>(6)</b>
3.1	Classification of wind turbines	1
3.2	power performance curve, Energy in wind, calculation of energy content,	2
3.3	Power coefficients, Betz limit theory, , tip speed ratio, solidity of turbine' power control strategies	2
3.4	Basic principles of Wind Energy Conversion Systems (WECS), Classification of WECS, Parts of WECS	1
4	<b>Ocean Energy</b>	<b>(6)</b>
4.1	Devices for Wave Energy conversion Ocean Thermal Energy Conversion (OTEC): Principle of OTEC system,	1

4.2	Methods of OTEC power generation – Open Cycle (Claude cycle), Closed Cycle (Anderson cycle) and Hybrid cycle (block diagram description of OTEC)	2
4.3	Geothermal energy: Introduction , hot dry rock resources, magma resources	1
4.4	vapor and liquid dominated systems, binary cycle, advantages and disadvantages	2
5	<b>Bio Mass Energy</b>	<b>(8)</b>
5.1	Biomass conversion technologies –Bio Gasification, Bio ethanol, Bio Diesel	1
5.2	Biogas production from waste biomass, factors affecting biogas generation Bio Gas -KVIC and Janata model.	2
5.3	Hydrogen Energy – various routes for production of Hydrogen energy	1
5.3	<b>Economic Analysis – Initial and annual cost, basic definitions,</b>	<b>1</b>
5.4	present worth calculations, repayment of loan in equal annual installments, annual savings, cumulative saving and life cycle cost	2
5.5	economic analysis of add on solar system, payback period(derivation)	1



CODE	COURSE NAME	CATEGORY	L	T	P	CREDIT
MET455	QUALITY ENGINEERING AND MANAGEMENT	OEC	2	1	0	3

**Preamble:** This course is designed to facilitate the students to understand the concept and culture of total quality management. It empowers the students by inculcating the skills to use quality control techniques and other quality tools in solving quality-related problems and apply these principles in an industry. This course will also amalgamate their knowledge about the importance of customer satisfaction through desired quality at a competitive price.

**Prerequisite:** NIL

**Course Outcomes:** After the completion of the course the student will be able to

CO 1	To be conversant with important terms for quality management in organisations
CO 2	Have a complete theoretical and practical understanding of the contributions of Quality Gurus
CO 3	Demonstrate knowledge of the underlying principles of strategic quality management
CO 4	Identify various human dimensions of TQM
CO 5	Implement different tools and techniques in TQM
CO 6	Implement different statistical quality control techniques

#### Mapping of course outcomes with program outcomes

	PO 1	PO 2	PO 3	PO 4	PO 5	PO 6	PO 7	PO 8	PO 9	PO 10	PO 11	PO 12
CO 1	3					2						3
CO 2	2											2
CO 3	2	2	2						3		1	3
CO 4	3					3			3		1	3
CO 5	2	3	3	2	2				2		2	2
CO 6	2	3	3	2	2				2		2	2

#### Assessment Pattern

Bloom's Category	Continuous Assessment Tests		End Semester Examination (in %)
	1 (in %)	2 (in %)	
Remember	20	20	20
Understand	60	40	40
Apply	20	40	40
Analyse			
Evaluate			
Create			

**Mark distribution**

<b>Total Marks</b>	<b>CIE Marks</b>	<b>ESE Marks</b>	<b>ESE Duration</b>
150	50	100	3 hours

**Continuous Internal Evaluation Pattern:**

Attendance	: 10 marks
Continuous Assessment Test (2 numbers)	: 25 marks
Assignment/Quiz/Course project	: 15 marks

**End Semester Examination Pattern:** There will be two parts; Part A and Part B. Part A contain 10 questions with 2 questions from each module, having 3 marks for each question. Students should answer all questions. Part B contains 2 questions from each module of which student should answer any one. Each question can have maximum 2 sub-divisions and carry 14 marks.

**Course Level Assessment Questions****Course Outcome 1 (CO1):**

1. Distinguish between quality control and inspection.
2. What are the TQM axioms?
3. What are the enablers of total quality?

**Course Outcome 2 (CO2)**

1. Describe the Deming approach to TQM.
2. List out Crosby's fourteen steps for quality improvement.
3. Describe Juran's quality trilogy.

**Course Outcome 3(CO3):**

1. Define strategic quality management.
2. With examples, describe the classification of quality costs.
3. Describe the concepts of Kaizen approach.

**Course Outcome 4 (CO4):**

1. What is meant by employee empowerment with respect to total quality management?
2. What are self managing teams?
3. Describe the importance of leadership in TQM

**Course Outcome 5 (CO5):**

1. “X and R charts always go hand in hand”. Elaborate.
2. What are the measures of Central tendency and dispersion?
3. Describe the principles of cause and effect diagram.

**Course Outcome 6 (CO6):**

1. Explain a typical OC curve for a control chart?
2. What are the effects of sample size on control limits?
3. Enumerate the differences between destructive and non-destructive testing methods.

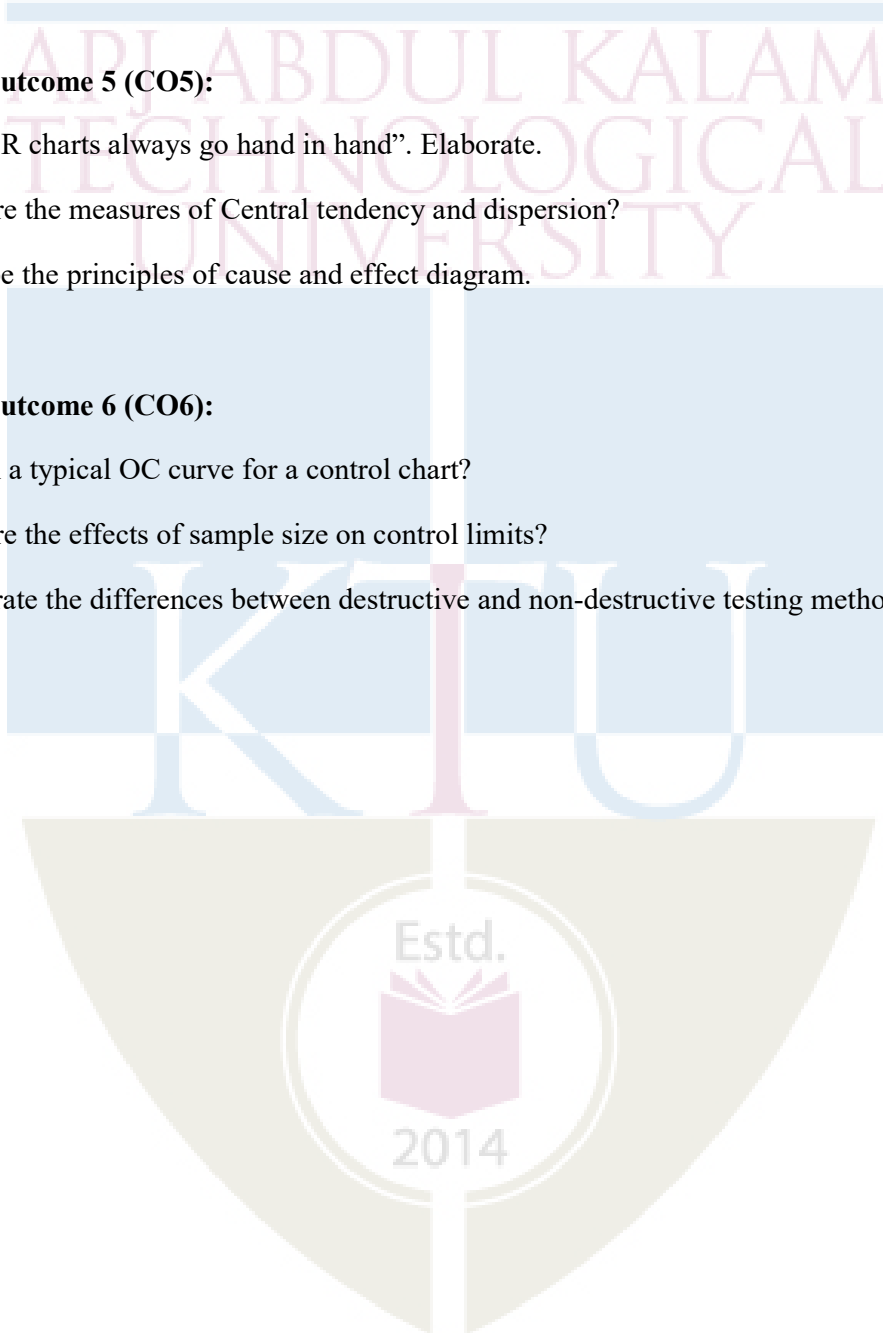

**Model Question Paper**

APJ ABDUL KALAM TECHNOLOGICAL UNIVERSITY  
SEVENTH SEMESTER B.TECH DEGREE EXAMINATION

Course Code: MET455

Course Name: Quality Engineering and Management

Max. Marks: 100

Duration: 3 Hours

**PART A****Answer ALL questions, each carries 3 marks.**

1. Define the term "Quality control".
2. What are the enablers of total quality?
3. Describe the concept of Quality Function Deployment
4. What are the obstacles to achieving successful strategic quality management?
5. What is meant by employee empowerment?
6. Describe the importance of leadership in TQM
7. What are the applications of control charts?
8. Differentiate between 100% inspection and sampling with suitable examples.
9. Describe the principles of cause and effect diagram.
10. What are the benefits of quality auditing?

**PART B**

- 11.a) Compare Juran and Deming approaches (7)  
b) Explain the characteristics of Total Quality Management. (7)

**OR**

- 12 a) Explain the three TQM axioms. (12)  
b) Define Quality Planning. (2)
13. Describe the steps to be followed to integrate quality into strategic management journey of an organization. (14)

**OR**

14. (a) Enumerate the objectives of 5S (7)  
(b) Describe the components of Quality cost. (7)
15. What are self managing teams? What are the benefits and problems associated with them? Indicate the key steps to be followed to implement them in organizations. (14)

**OR**

16. What are the ingredients for success for a quality director? What are the activities to be carried out by a quality director towards assisting upper management with strategic management (14)

17. With the aid of examples, describe the types of failure. (14)

OR

18. What are the different phases of a bath tub curve? With the help of a sketch, illustrate the important features of each phase. (14)

19. Describe the steps to be followed for conducting a quality audit. (14)

OR

20. Following are the data on the quality costs incurred in a manufacturing company in a month:

Title of the quality cost	Amount in Rupees
Product audits	1,000
Scrap Disposal	50,000
Concessions and Downgrading	40,000
Calibration	2,000
Quality planning	500
Manufacturing losses	30,000
System failure	40,000
Test materials	5,000
Training	2,000
Customer returns	25,000

Classify the above quality costs into preventive, appraisal and failure costs. Conduct Pareto analysis and comment on the results. Suggest a proposal with anticipation on the quality costs observable in future. (14)

## Syllabus

### Module 1

Introduction to Quality Engineering - Definitions of the terms - quality, quality planning, quality control, quality assurance, quality management, Total Quality Management (TQM)- overview on TQM - the TQM axioms - consequences of total quality- Barriers to TQM- Deming approach to TQM – Juran’s quality trilogy- Crosby's fourteen steps for quality improvement

### Module 2

Strategic Quality Management: Cost of Quality- Customer satisfaction- Quality Function Deployment (QFD)- Integrating quality into strategic management - obstacles to achieving successful strategic quality management- Concepts of 5S, Six Sigma, Kaizen.

### Module 3

Human dimensions of TQM – Top management commitment- Leadership for TQM- Change management- resources for quality activities - training for quality –Employee involvement, motivation empowerment- teamwork- self managing teams - role of the quality director- Quality System: ISO 9000 family of standards.

### Module 4

Quality control and Inspection- Destructive and non-destructive testing methods- process capability- Statistical quality control –Acceptance sampling- causes of variation in quality- control charts for X and R, Problems- Reliability-types and causes of failures- Bath tub curve.-System reliability- life testing.

### Module 5

Supporting Tools, Activities And Techniques in TQM Projects : Affinity diagram - brainstorming - cause and effect analysis - process flow chart – check sheets- Scatter diagram - Pareto chart- Histogram and fundamentals of statistics - Taguchi’s robust design- Total Productive maintenance- Failure Mode and Effect Analysis - Quality auditing- types and benefits.

### Text Books

1. Besterfield Dale H. , Besterfield Carol, Besterfield Glen H., Besterfield Mary, Urdhwareshe Hemant, Urdhwareshe Rashmi, “Total Quality Management (TQM) 5e”, Pearson Education, 2018.
2. Subburaj Ramasamy, “Total Quality Management”, McGraw Hill Education,, 2017.
3. Dr. K.C. Arora, “Total Quality Management”, S K Kataria and Sons, 2013.
4. Suganthi, L and Anand A Samuel, “Total Quality Management”, Prentice Hall India Learning Private Limited, 2009.

5. Juran J M and Gryna, F M, "Quality Planning and Analysis - From Product Development through Use", Tata McGraw Hill Publishing Limited, New Delhi, Third Edition, 2004.

### Reference Books

1. Logothetics N, "Managing for Total Quality - From Deming to Taguchi and SPC", Prentice Hall Ltd., New Delhi, 1997.
2. Deming W E, "Out of the Crisis," MIT Press, Cambridge, MA, 1982.
3. Juran J M and Juran on "Leadership for Quality" An Executive Handbook, The Free Press, New York, 1989.
4. Salor J H, "TQM-Field Manual," McGraw Hill, New York, 1992.
5. Crosby P B, "Quality is Free" McGraw Hill, New York, 1979.

### Course Contents and Lecture Schedule

No	Topic	No. of Lectures
1	<b>Introduction to Quality Engineering</b>	
1.1	Definitions of the terms - quality, quality planning, quality control, quality assurance, quality management	2
1.2	Total Quality Management (TQM)- overview on TQM - the TQM axioms - consequences of total quality- Barriers to TQM	2
1.3	Deming approach to TQM - Juran quality trilogy- Crosby's fourteen steps for quality improvement	3
2	<b>Strategic Quality Management</b>	
2.1	Cost of Quality- Customer satisfaction- Quality Function Deployment (QFD)	2
2.2	Integrating quality into strategic management - quality and the management cycle	1
2.3	obstacles to achieving successful strategic quality management	1
2.4	Concepts of 5S, Six Sigma, Kaizen	2
3	<b>Human dimensions of TQM</b>	
3.1	Top management commitment- Leadership for TQM- Change management	2
3.2	Resources for quality activities - training for quality	1
3.3	Employee involvement, motivation, empowerment	2
3.3	Teamwork- self managing teams - role of the quality director	1
3.4	Quality System: ISO 9000 family of standards.	1
4	<b>Quality control and Inspection</b>	
4.1	Destructive and non-destructive testing methods	1
4.2	Process capability- Statistical quality control –acceptance sampling- causes of variation in quality	2
4.3	Control charts for X and R. Reliability-	3

4.4	causes of failures- Bath tub curve	1
4.5	System reliability- life testing	1
5	<b>Supporting Tools, Activities And Techniques in TQM Projects</b>	
5.1	Affinity diagram - brainstorming	1
5.2	Cause and effect analysis - process flow chart – check sheets- Scatter diagram - Pareto chart	3
5.3	Histogram and fundamentals of statistics	1
5.4	Taguchi's robust design- Total Productive maintenance- Failure Mode and Effect Analysis	2
5.5	Quality auditing- types and benefits	1



APJ ABDUL KALAM  
TECHNOLOGICAL  
UNIVERSITY

**SEMESTER VII**

**MINOR**



MED481	MINI PROJECT	CATEGORY	L	T	P	CREDIT
		PWS	0	0	3	4

**Preamble:** Mini Project Phase I: A Project topic must be selected either from research literature or the students themselves may propose suitable topics in consultation with their guides. The object of Project Work I is to enable the student to take up investigative study in the broad field of Mechanical Engineering, either fully theoretical/practical or involving both theoretical and practical work to be assigned by the Department on a group of three/four students, under the guidance of a Supervisor. This is expected to provide a good initiation for the student(s) in R&D work. The assignment to normally include:

- ◆ Survey and study of published literature on the assigned topic;
- ◆ Preparing an Action Plan for conducting the investigation, including team work;
- ◆ Working out a preliminary Approach to the Problem relating to the assigned topic;
- ◆ Block level design documentation
- ◆ Conducting preliminary Analysis/ Modelling/ Simulation/ Experiment/ Design/ Feasibility;
- ◆ Preparing a Written Report on the Study conducted for presentation to the Department;

CO1	Identify and synthesize problems and propose solutions to them.
CO2	Prepare work plan and liaison with the team in completing as per schedule.
CO3	Validate the above solutions by theoretical calculations and through experimental
CO4	Write technical reports and develop proper communication skills.
CO5	Present the data and defend ideas.

#### Mapping of course outcomes with program outcomes

	PO1	PO2	PO3	PO4	PO5	PO6	PO7	PO8	PO9	PO10	PO11	PO12
CO1	3	3	3	3					3	3		2
CO2	3			3				3	3	3	3	
CO3	3	3	3	3	3					3		
CO4					3			3	3	3		1
CO5	3	3	3	3				3		3	3	1

\*1-slight/low mapping, 2- moderate/medium mapping, 3-substantial/high mapping

## Assessment Pattern

The End Semester Evaluation (ESE) will be conducted as an internal evaluation based on the product, the report and a viva- voce examination, conducted by a 3-member committee appointed by Head of the Department comprising HoD or a senior faculty member, academic coordinator for that program and project guide/coordinator. The Committee will be evaluating the level of completion and demonstration of functionality/specifications, presentation, oral examination, working knowledge and involvement.

The Continuous Internal Evaluation (CIE) is conducted by evaluating the progress of the mini project through minimum of TWO reviews. At the time of the 1<sup>st</sup> review, students are supposed to propose a new system/design/idea, after completing a thorough literature study of the existing systems under their chosen area. In the 2<sup>nd</sup> review students are expected to highlight the implementation details of the proposed solution. The review committee should assess the extent to which the implementation reflects the proposed design. A well coded, assembled and completely functional product is the expected output at this stage. The final CIE mark is the average of 1<sup>st</sup> and 2<sup>nd</sup> review marks.

A zeroth review may be conducted before the beginning of the project to give a chance for the students to present their area of interest or problem domain or conduct open brain storming sessions for innovative ideas. Zeroth review will not be a part of the CIE evaluation process.

## Marks Distribution

Total Marks	CIE	ESE
150	75	75

## Continuous Internal Evaluation Pattern:

Attendance : 10 marks  
Marks awarded by Guide : 15 marks  
Project Report : 10 marks  
Evaluation by the Committee : 40 Marks

**End Semester Examination Pattern:** The following guidelines should be followed regarding award of marks.

- (a) Demonstration : 50 Marks
- (b) Project report : 10 Marks
- (d) Viva voce : 15marks

## Course Plan

In this course, each group consisting of three/four members is expected to design and develop a moderately complex software/hardware system with practical applications. This should be a working model. The basic concept of product design may be taken into consideration.

Students should identify a topic of interest in consultation with Faculty-in-charge of miniproject/Advisor. Review the literature and gather information pertaining to the chosen topic. State the objectives and develop a methodology to achieve the objectives. Carryout the design/fabrication or develop codes/programs to achieve the objectives. Demonstrate the novelty of the project through the results and outputs. The progress of the mini project is evaluated based on a minimum of two reviews.

The review committee may be constituted by the Head of the Department. A project report is required at the end of the semester. The product has to be demonstrated for its full design specifications. Innovative design concepts, reliability considerations, aesthetics/ergonomic aspects taken care of in the project shall be given due weight.

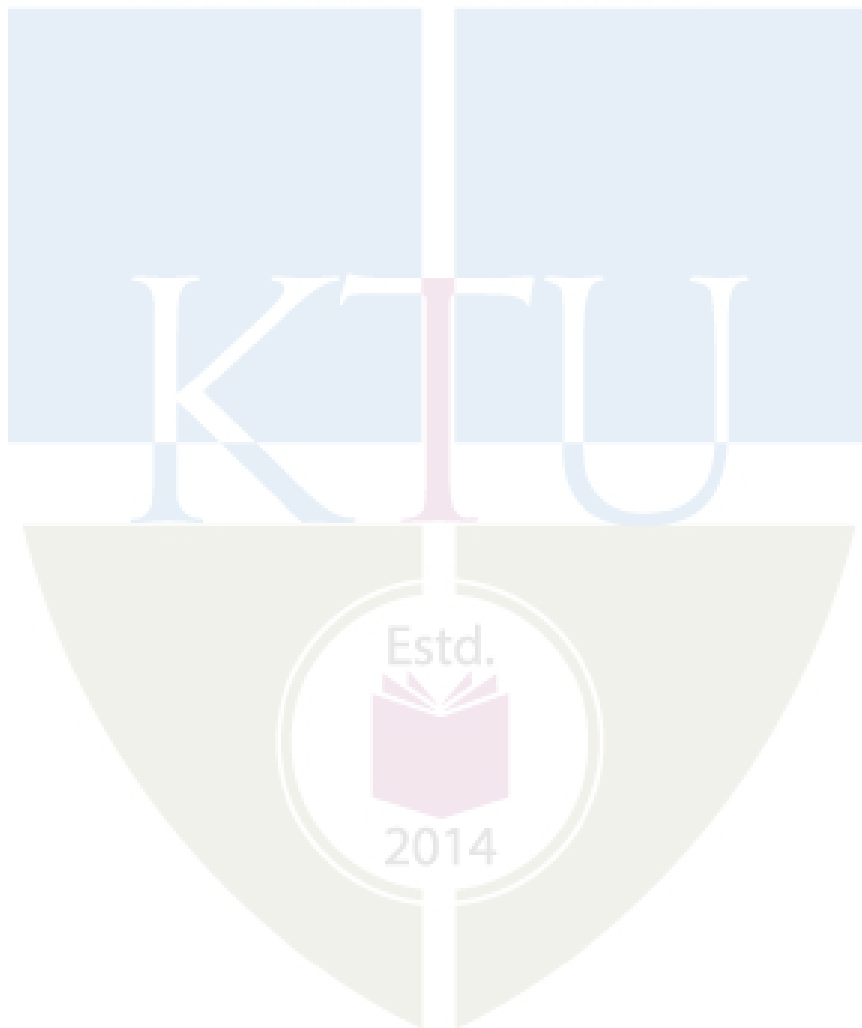

APJ ABDUL KALAM  
TECHNOLOGICAL  
UNIVERSITY

**SEMESTER VII**

**HONOURS**



CODE	COURSE NAME	CATEGORY	L	T	P	CREDIT
MET495	ADVANCED THEORY OF VIBRATIONS	VAC	4	0	0	4

**Preamble:**

- To understand the principles of vibration theory.
- To introduce techniques for solving vibration problems.
- To enable development of mathematical model for engineering problems in vibrations.

**Prerequisite:** MET 304 Dynamics and Design of Machinery

**Course Outcomes:** After the completion of the course the student will be able to

CO 1	Analyse the single degree of freedom vibration system with and without damping
CO 2	Analyse forced harmonic vibration and two degree of freedom system
CO 3	Analyse the multi degree of freedom system and the Eigen value problem
CO 4	Solve vibration of continuous systems and transient vibrations
CO 5	Solve the numerical methods used in vibration analysis

**Mapping of course outcomes with program outcomes**

	PO 1	PO 2	PO 3	PO 4	PO 5	PO 6	PO 7	PO 8	PO 9	PO 10	PO 11	PO 12
CO 1	3	3	3									
CO 2	3	3	3									
CO 3	3	3	3									
CO 4	3	3	3									
CO 5	3	3	3									

**Assessment Pattern**

Bloom's Category	Continuous Assessment Tests		End Semester Examination
	1	2	
Remember			
Understand	10	10	30
Apply	40	40	70
Analyse			
Evaluate			
Create			

**Mark distribution**

<b>Total Marks</b>	<b>CIE</b>	<b>ESE</b>	<b>ESE Duration</b>
150	50	100	3 hours

**Continuous Internal Evaluation Pattern:**

Attendance	: 10 marks
Continuous Assessment Test (2 numbers)	: 25 marks
Assignment/Quiz/Course project	: 15 marks

**End Semester Examination Pattern:** There will be two parts; Part A and Part B. Part A contain 10 questions with 2 questions from each module, having 3 marks for each question. Students should answer all questions. Part B contains 2 questions from each module of which student should answer any one. Each question can have maximum 2 sub-divisions and carry 14 marks.

**Course Level Assessment Questions****Course Outcome 1 (CO1):**

1. Explain about different types of vibrating mechanisms.
2. Describe Energy method and Rayleigh method.
3. Explain the different damping mechanisms.

**Course Outcome 2 (CO2)**

1. Describe about the magnification factor and transmissibility.
2. What is normal mode vibration and coordinate coupling.
3. Explain the working of seismometer and accelerometer.

**Course Outcome 3(CO3):**

1. Describe about Dynamic vibration absorbers and Vibration dampers
2. Explain the mode shape and Modal analysis.
3. What is Eigen value and Eigen vector.

**Course Outcome 4 (CO4):**

1. Discuss about the vibrating strings and longitudinal vibration of rods.
2. Explain the Torsional vibration of rods
3. Explain the Transient vibrations

**Course Outcome 5 (CO5):**

1. Explain Matrix Iteration and Stodola method– Dunkerley’s method
2. Differentiate between Rayleigh method and Rayleigh –Ritz method
3. What is Holzer procedure for vibration analysis



**Model Question Paper**

**APJ ABDUL KALAM TECHNOLOGICAL UNIVERSITY  
SEVENTH SEMESTER B. TECH DEGREE EXAMINATION**

**Course Code: MET 475**

**Course Name: ADVANCED THEORY OF VIBRATIONS**

**Max. Marks: 100**

**Duration: 3 Hours**

**PART – A**

**(ANSWER ALL QUESTIONS, EACH QUESTION CARRIES 3 MARKS)**

1. Distinguish between longitudinal, transverse and torsional vibrations?
2. What are beats?
3. Explain the working of a vibrometer?
4. How does the force transmitted to the base change as the speed of the machine increases?
5. What is orthogonality of modes?
6. What are influence coefficients?
7. What is the Duhamel Integral? What is its use?
8. State the boundary conditions at the end of a string.
9. What is the basic principle used in Holzer's method?
10. Write short notes on n Rayleigh Ritz Method.

**PART – B**

**(ANSWER ONE FULL QUESTION FROM EACH MODULE)**

**MODULE – 1**

11. A machine of mass 18kg is supported on springs of total stiffness 12N/mm and dashpot of 0.2Ns/m damping. The system is initially at rest and a velocity of 120mm/s is imparted to the machine. Determine the displacement and velocity of machine as a function of time?  
(14 marks)
12. A circular cylinder as shown below, has a mass 6kg and radius 20cm, which is joined to the fixture by a spring having stiffness 5000N/m. It is free to roll on the horizontal surface without slipping. Find the natural frequency of the system?

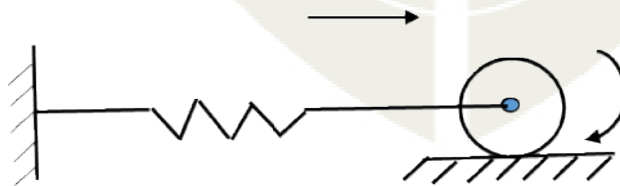

(14 marks)

**Module 2**

13. A machine component having a mass of 3kg vibrates in a viscous medium. If a harmonic force 40N is applied on the system causes a resonant amplitude of 15mm with a period of 0.25second, find the damping coefficient? Find the increase in the amplitude of the forced when the damper is removed, if the frequency of exciting force is changed to 4 Hz?

(14 marks)

14. Design Derive the general equation for damped free vibration of a single degree of freedom system? Arrive at the equation of under damped system?

(14 marks)

**Module 3**

15. Find out the natural frequency of the system given below using influence coefficient method?

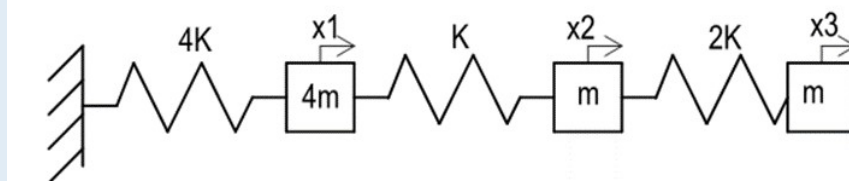

(14 marks)

16. A reciprocating machine has a weight of 250N which runs at a constant speed of 500rpm. It was found after final installation that the forcing frequency is very close to the natural frequency of the system. Find the mass of the dynamic absorber to be added to the system, the nearest natural frequency of the system should be at least 25 percent from the impressed frequency?

(14 marks)

**Module 4**

17. Derive an expression for the torsional vibration in case of a shaft having torque T acting at both the ends?

(14 marks)

18. a) Derive the impulse response function of a damped free vibration system? (7 marks)  
b) A trailer being pulled at a high speed, hits a h cm high curb. Considering the trailer to be single degree of freedom system, analyse the system for the response.

(7 marks)

**Module 5**

19. Using Stodola technique determine the first natural frequency of the following system?

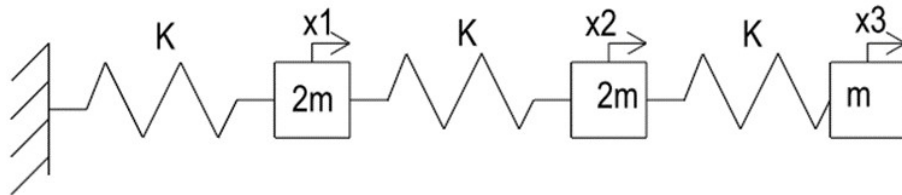

(14 marks)

20. Find out the natural frequency of the system given below using matrix iteration method?

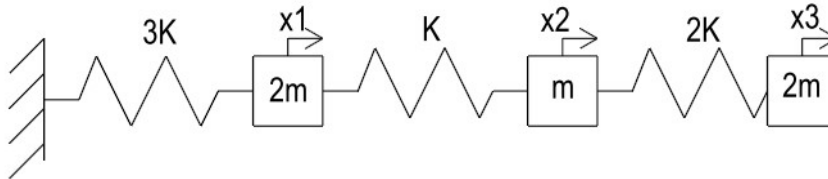

(14 marks)

### Syllabus

#### Module 1

Introduction to mechanical vibrations- Definitions -Types of vibrations- Degrees of freedom- Oscillatory motion – Periodic motion- Beat phenomenon

Free vibration of single degree of freedom systems with damping - Natural frequency using Energy method- Rayleigh method- Newton's method

Free vibration of single degree of freedom systems with damping- Viscous damping- Logarithmic decrement-

Coulomb damping- - Structural damping

#### Module 2

Forced harmonic vibration- Magnification Factor-Transmissibility-Vibration Isolation-Base Excitation-Rotating unbalance- whirling of shafts- Resonance

Vibration measuring instruments- Seismometer-Accelerometer

Two degree of freedom systems- Generalized co-ordinates- Normal mode vibration-Principal co-ordinates-Coordinate coupling.

#### Module 3

Dynamic vibration absorbers- Vibration dampers- Numerical problems

Multi degree of freedom systems- Matrix formulation- Influence Coefficients-Flexibility Matrix-Stiffness matrix

Eigen Value problem: Eigen value and Eigen Vectors-Natural Frequency- mode shape - Orthogonality of normal modes-Modal analysis

#### **Module 4**

Vibration of continuous systems-Vibrating strings- Longitudinal vibration of rods—Torsional vibration of rods

Transient vibrations- Impulse excitation- Convolution integral,Response to Arbitrary Loading.

#### **Module 5**

Numerical methods - Matrix Iteration – Stodola – Dunkerley’s method - Rayleigh method – Rayleigh –Ritz method -Holzer procedure

#### **Text Books**

1. A. G. Ambekar, “Mechanical Vibrations and Noise Engineering, PHI, New Delhi
2. V.P. Singh “Mechanical Vibrations” DhanpatRai& Co (Pvt) Ltd.

#### **Reference Books**

1. Thomson W.T , Theory of Vibration with Applications., PHI, New Delhi
2. Rao V and J Srinivas, Mechanical Vibrations, PHI, New Delhi
3. S.S Rao, Mechanical Vibrations, Pearson Education India

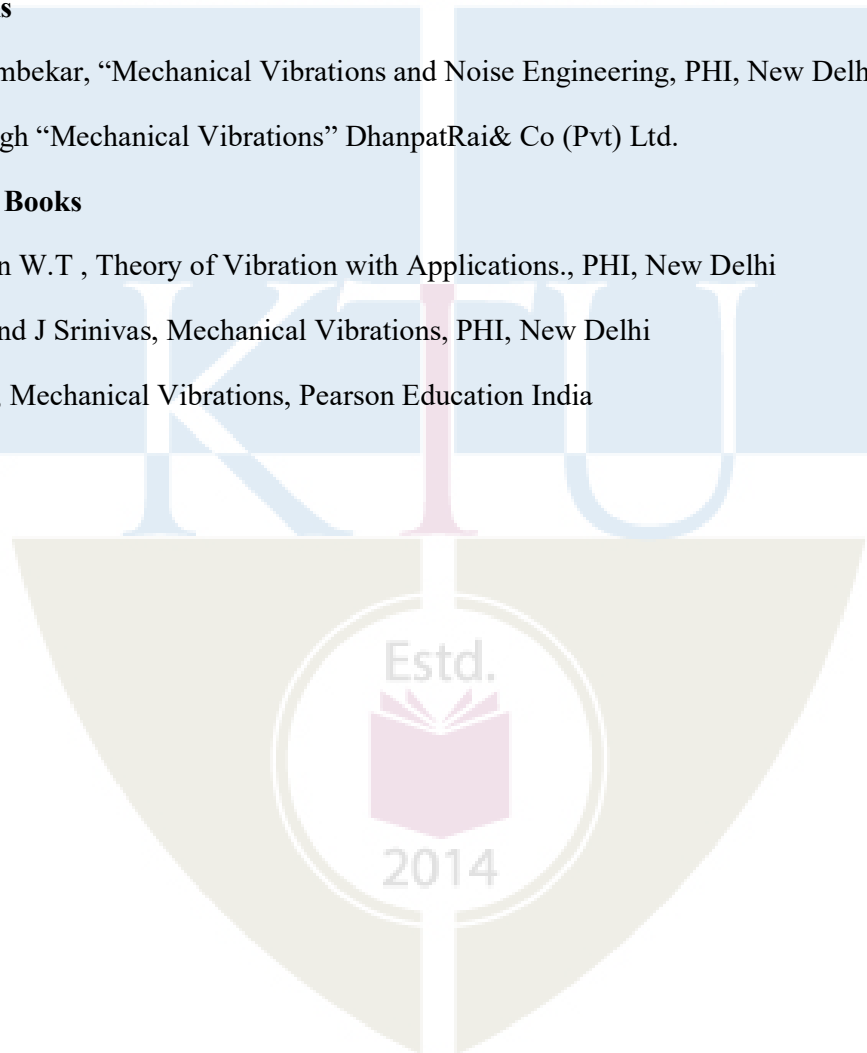

**Course Contents and Lecture Schedule**

No	Topic	No. of Lectures
<b>1</b>	<b>Module 1</b>	
1.1	Introduction to mechanical vibrations- Definitions -Types of vibrations- Degrees of freedom- Oscillatory motion – Periodic motion- Beat phenomenon	3
1.2	Free vibration of single degree of freedom (DOF) systems with damping - Natural frequency using Energy method- Rayleigh method- Newton's method	3
1.3	Free vibration of single degree of freedom (DOF) systems with damping- Viscous damping- Logarithmic decrement- Coulomb damping- - Structural damping	3
<b>2</b>	<b>Module 2</b>	
2.1	Forced harmonic vibration- Magnification Factor- Transmissibility-Vibration Isolation-Base Excitation-Rotating unbalance- whirling of shafts- Resonance	4
2.2	Vibration measuring instruments- Seismometer-Accelerometer	2
2.3	Two degree of freedom systems- Generalized co-ordinates- Normal mode vibration-Principal co-ordinates-Coordinate coupling.	4
<b>3</b>	<b>Module 3</b>	
3.1	Dynamic vibration absorbers- Vibration dampers- Numerical problems	2
3.2	Multi degree of freedom systems- Matrix formulation- Influence Coefficients-Flexibility Matrix-Stiffness matrix	4
3.3	Eigen Value problem: Eigen value and Eigen Vectors-Natural Frequency- mode shape -Modal analysis	4
<b>4</b>	<b>Module 4</b>	
4.1	Vibration of continuous systems-Vibrating strings- Longitudinal vibration of rods—Torsional vibration of rods	4
4.2	Transient vibrations- Impulse excitation- Convolution integral.	4
<b>5</b>	<b>Module 5</b>	
5.1	Numerical methods - Matrix Iteration – Stodola – Dunkerley's method -	4
5.2	Rayleigh method – Rayleigh –Ritz method -Holzer procedure	4

CODE	COURSE NAME	CATEGORY	L	T	P	CREDIT
MET497	COMPUTATIONAL METHODS IN FLUID FLOW AND HEAT TRANSFER	VAC	3	1	0	4

**Preamble:** COMPUTATIONAL METHODS IN FLUID FLOW & HEAT TRANSFER focuses on basic concept and principles of numerically solving governing equations for fluid flow and heat transfer problems.

**Prerequisite:** MET203 Mechanics of Fluids, MET302 Heat and Mass Transfer

**Course Outcomes:** After the completion of the course the student will be able to

CO 1	Explain physical and mathematical classifications partial differential equations, discretization, Steady one-dimensional conduction in Cartesian and cylindrical coordinates,,
CO 2	Analyse One-, two, and three-dimensional steady state and transient heat conduction problems in Cartesian and cylindrical coordinates
CO 3	Explain Explicit, implicit, Crank-Nicholson and ADIschemes,; consistency, stability and convergence.
CO 4	Analyse finite volume method for diffusion and convection

#### Mapping of course outcomes with program outcomes

	PO 1	PO 2	PO 3	PO 4	PO 5	PO 6	PO 7	PO 8	PO 9	PO 10	PO 11	PO 12
CO 1	✓	✓	✓									
CO 2	✓	✓	✓									
CO 3	✓	✓	✓									
CO 4	✓	✓	✓									

#### Assessment Pattern

Bloom's Category	Continuous Assessment Tests		End Semester Examination
	1	2	
Remember	10	10	20
Understand	20	20	40
Apply	10	10	20
Analyse	10	10	20
Evaluate			
Create			

**Mark distribution**

<b>Total Marks</b>	<b>CIE</b>	<b>ESE</b>	<b>ESE Duration</b>
150	50	100	3 hours

**Continuous Internal Evaluation Pattern:**

Attendance	: 10 marks
Continuous Assessment Test (2 numbers)	: 25 marks
Assignment/Quiz/Course project	: 15 marks

**End Semester Examination Pattern:** There will be two parts; Part A and Part B. Part A contain 10 questions with 2 questions from each module, having 3 marks for each question. Students should answer all questions. Part B contains 2 questions from each module of which student should answer any one. Each question can have maximum 2 sub-divisions and carry 14 marks.

**Course Level Assessment Questions****Course Outcome 1 (CO1):**

1. Explain the concept of discretization.
2. Explain the term “ Rate of Convergence”.

**Course Outcome 2 (CO2)**

1. Differentiate between Dirichlet and Newmann Boundary conditions.
2. Explain how discretization of irregular boundaries are done ?

**Course Outcome 3(CO3):**

1. Explain the significance of ADI scheme
2. Give the stability criterion of Crank Nicholson Scheme.

**Course Outcome 4 (CO4):**

1. Explain the reason for using finite volume method for convection and diffusion problems?
2. Differentiate between Hybrid and Upwind Schemes.

**Model Question Paper**

**APJ ABDUL KALAM TECHNOLOGICAL UNIVERSITY  
SEVENTH SEMESTER B.TECH DEGREE EXAMINATION**

**Course Code: MET497**

**Course Name: COMPUTATIONAL METHODS IN FLUID FLOW & HEAT  
TRANSFER**

Max. Marks: 100

Duration: 3 Hours

**PART – A**

(ANSWER ALL QUESTIONS, EACH QUESTION CARRIES 3 MARKS)

1. What are the various errors encountered in the solution by computational methods?
2. Describe the Tridiagonal matrix algorithm (TDMA)
3. Explain the significance of line by line method of solutions
4. Give two examples of Dirichlet boundary conditions
5. Distinguish between Explicit and Implicit schemes, compare the advantages and disadvantages for each.
6. Write Crank-Nicolson FDE for  $\frac{\partial u}{\partial t} = \alpha \frac{\partial^2 u}{\partial x^2}$
7. Write a typical convection and diffusion equation in conservative form.
8. What is the benefit of conservative form of equations?
9. Differentiate between SIMPLE and SIMPLER algorithms
10. Write short notes on QUICK scheme

**PART – B**

(ANSWER ONE FULL QUESTION FROM EACH MODULE)

**MODULE – 1**

11. a) What is under relaxation? Give one formula each for PSOR and LSOR. (7 Marks)
- b) Why stability is to be ensured for numerical schemes? How is it done? (7 marks)

**OR**

12. With the help of suitable examples explain Taylor's series approach and polynomial fitting approach (14 marks)

**MODULE – 2**

13. a) Explain formation of discretized equations for regular and irregular boundaries with suitable examples (14 marks)

**OR**

14. Explain solution procedure for two dimensional steady state heat conduction problems (14 marks)

**MODULE – 3**

15. a) Write and explain the ADI formulation for the PDE  $\frac{\partial u}{\partial t} = \nu \left( \frac{\partial^2 u}{\partial x^2} + \frac{\partial^2 u}{\partial y^2} \right)$  (9 marks)

- b) Write Crank-Nicolson FDE for  $\frac{\partial u}{\partial t} = \alpha \frac{\partial^2 u}{\partial x^2}$  (5 marks)

**OR**

16. a) Write the ADI formulation for the PDE  $\frac{\partial^2 u}{\partial x^2} + \frac{\partial^2 u}{\partial y^2} = 0$  (6 marks)

- b) Explain the stability criterion of ADI and Crank Nicolson Schemes. (8 marks)

**MODULE – 4**

17. Discuss advantages and limitations of the following with respect to convection and diffusion equation

- i) Upwind scheme
  - ii) Hybrid scheme
  - iii) Power-Law scheme
- (14 Marks)

**OR**

18. a) Write a typical convection and diffusion equation in conservative form. (7 marks)

- b) Explain the concept of false diffusion (7 marks)

**MODULE – 5**

19. a) What is the main difficulty in solving momentum equations (4 marks)

- b) How the pressure correction equation is formulated for SIMPLE procedure (10 Marks)

OR

20. a) Explain the sequence of operations in the SIMPLE procedure with a flowchart (7 marks)
- b) Explain the significance of SIMPLEC scheme using example (7 marks)

### Syllabus

#### Module 1

Experimental, theoretical and numerical methods of predictions, physical and mathematical classifications partial differential equations; computational economy; numerical stability; validation of numerical results; round-off-error and accuracy of numerical results; iterative convergence, condition for convergence, rate of convergence; under and over relaxations, termination of iteration; tridiagonal matrix algorithm; discretization, converting derivatives to their finite difference forms, Taylor's series approach, polynomial fitting approach; discretization error.

#### Module 2

Steady one-dimensional conduction in Cartesian and cylindrical coordinates; handling of boundary conditions; two dimensional steady state conduction problems in Cartesian and cylindrical coordinates, point-by-point and line-by-line method of solution, dealing with Dirichlet, Neumann, and mixed type boundary conditions, formation of discretized equations for regular and irregular boundaries and interfaces.

#### Module 3

One-, two-, and three-dimensional transient heat conduction problems in Cartesian and cylindrical coordinates, explicit, implicit, Crank Nicholson and ADI schemes. Stability criterion of these schemes, conservation form and conservative property of partial differential and finite difference equations

#### Module 4

Finite volume method for diffusion and convection-diffusion problems, steady one dimensional convection and diffusion; upwind, hybrid and power-law schemes, discretization of equation for two dimension, false diffusion,

#### Module 5

SIMPLE, SIMPLER, SIMPLEC and QUICK schemes, solution algorithms for pressure velocity coupling in steady flows; numerical marching techniques, two dimensional parabolic flows with heat transfer.

**Text Books**

1. Anderson, D. A, Tannehill, J. C., and R. H. Pletcher, R. H., Computational Fluid Mechanics and Heat Transfer, Second Edition, Taylor & Francis, 1995.

**Reference Books**

1. T.J. Chung, Computational Fluid dynamics, Cambridge University Press, South Asian Edition, 2003.

2. Muraleedhar, K. and T. Sundararaja, T., Computational Fluid Flow and Heat Transfer, Second Edition, Narosa Publishing House, 2003.

3. Patankar, S. V., Numerical Heat Transfer and Fluid Flow, Hemisphere, 1980.

4. Versteeg, H. K. and W. Malalasekera, An Introduction to Computational Fluid Dynamics: The Finite Volume Method, Addison Wesley–Longman, 1995.

5. Hornbeck, R. W., Numerical Marching Techniques for Fluid Flows with Heat Transfer, NASA,

SP – 297, 1973.

**Course Contents and Lecture Schedule**

No	Topic	No. of Lectures
1.1	Experimental, theoretical and numerical methods of predictions, physical and mathematical classifications partial differential equations; computational economy;	4
1.2	Validation of numerical results; round-off-error and accuracy of numerical results; iterative convergence, condition for convergence, rate of convergence; under and over relaxations,	3
1.3	Termination of iteration; tridiagonal matrix algorithm; discretization, converting derivatives to their finite difference forms, Taylor's series approach, polynomial fitting approach; discretization error.	3
2.1	Steady one-dimensional conduction in Cartesian and cylindrical coordinates; handling of boundary conditions; two dimensional steady state conduction problems in Cartesian and cylindrical coordinates,	3
2.2	Point-by-point and line-by-line method of solution, dealing with Dirichlet, Neumann, and bins type boundary conditions	2
2.3	Formation of discretized equations for regular and irregular boundaries and interfaces.	2
3.1	One-, two, and three-dimensional transient heat conduction problems in Cartesian and cylindrical coordinates, explicit, implicit, Crank Nicholson and ADI schemes	4

3.2	Stability criterion of these schemes, conservation form and conservative property of partial differential and finite difference equations	3
4.1	Finite volume method for diffusion and convection–diffusion problems, steady one dimensional convection and diffusion;	3
4.2	Upwind, hybrid and power-law schemes, discretization of equation for two dimension, false diffusion,	3
5.1	SIMPLE, SIMPLER, SIMPLEC and QUICK schemes, solution algorithms for pressure velocity coupling in steady flows;	3
5.2	Numerical marching techniques, two dimensional parabolic flows with heat transfer.	2



CODE	COURSE NAME	CATEGORY	L	T	P	CREDIT
MET499	PRECISION MACHINING	VAC	3	1	0	4

**Preamble:** This course is conceived to help students understand design and process issues associated with precision machining. The course introduces a few precision machining processes as well.

**Prerequisite:** Nil

**Course Outcomes:** After the completion of the course the student will be able to:

CO 1	Contrast basic premises of normal machining and precision machining
CO 2	Relate consideration of error and sources of error and role of kinematic design in establishing precision.
CO 3	Explain various sensors and AE based monitoring in precision machining environment
CO 4	Outline the basics of process planning for precision machining
CO 5	Explain various precision machining processes.

**Mapping of course outcomes with program outcomes:**

	PO 1	PO 2	PO 3	PO 4	PO 5	PO 6	PO 7	PO 8	PO 9	PO 10	PO 11	PO 12
CO 1	3	1	-	-	3	-	1	-	2	1	1	1
CO 2	3	1	-	-	3	-	1	-	2	1	1	1
CO 3	3	1	-	-	3	-	1	-	2	1	1	1
CO 4	3	1	-	-	3	-	1	-	2	1	1	1
CO 5	3	1	-	-	3	-	1	-	2	1	1	1
CO 6	3	1	-	-	3	-	1	-	2	1	1	1

**Assessment Pattern**

Bloom's Category	Continuous Assessment Tests		End Semester Examination (marks)
	1 (marks)	2 (marks)	
Remember	20	20	40
Understand	20	20	40
Apply	10	10	20
Analyse	-	-	-
Evaluate	-	-	-
Create	-	-	-

**Mark distribution**

<b>Total Marks</b>	<b>CIE</b>	<b>ESE</b>	<b>ESE Duration</b>
150	50	100	3 hours

**Continuous Internal Evaluation Pattern**

Attendance	: 10 marks
Continuous Assessment Test (2 numbers)	: 25 marks
Assignment/Quiz/Course project	: 15 marks

**End Semester Examination Pattern:** There will be two parts; Part A and Part B. Part A contains 10 questions with 2 questions from each module, having 3 marks for each question. Students should answer all questions. Part B contains 2 questions from each module, of which student should answer any one. Each question can have maximum 2 sub-divisions and carry 14 marks.

**Course Level Assessment Questions****Course Outcome 1 (CO1):**

1. What is Abbe's principle? List an instrument each which (a) obeys Abbe's principle (b) disobeys Abbe's principle.
2. List down various methods for testing roundness. Explain precision spindle method for checking roundness with a suitable diagram.
3. With the help of a neat diagram, explain surface roughness terminology.

**Course Outcome 2 (CO2):**

1. With the help of a suitable diagram, show the directions in which errors occur for a conventional machine tool.
2. What is an error budget? How does an error budget flow chart help in generating it?
3. Describe thermal effects in precision machining.

**Course Outcome 3 (CO3):**

1. Explain AE based topographical mapping of grinding wheels.
2. Describe AE based monitoring of face milling.
3. Explain fast AE RMS analysis for wheel condition monitoring.

**Course Outcome 4 (CO4):**

1. Define capability ratio.
2. Discuss the basics of process planning in precision machining process?
3. Illustrate with an example the application of capability ratio in process planning.

**Course Outcome 5 (CO5):**

1. Discuss typical fly cutting diamond machine configurations.
2. Discuss tool-workpiece configurations for conical- circumferential milling.
3. Discuss the tool geometry of a typical single point diamond tool.



**Model Question Paper****MET499 PRECISION MACHINING**

Max. Marks: 100

Duration: 3 hours

**Part-A****Answer all questions. Each question carries 3 marks**

1. Enumerate critical elements in precision manufacturing.
2. Clearly distinguish the terms accuracy, precision and resolution.
3. Distinguish between kinematic design and elastically averaged design.
4. What do you understand by macroscale and microscale structural compliance?
5. Which are the basic sensor types used in precision manufacturing set ups?
6. Tabulate various forms of energy converted by sensors.
7. Define process capability.
8. What are the factors that affect precision during machining?
9. Differentiate between fixed abrasive process and loose abrasive process.
10. Draw a schematic and hence outline a nano-grinding process.

**Part-B****Answer one full question from each module.****Module I**

11. Differentiate normal machining, precision machining and ultra-precision machining with examples (14 marks)

**OR**

12. Describe various “competitive drivers” of precision manufacturing. (14 marks)

**Module II**

13. What do you understand by microscale and macroscale structural compliance. Explain. (14 marks)

**OR**

14. With the help of a neat diagram explain Air bearing grinding spindle. (14 marks)

**Module III**

15. Explain requirements for sensor technology for precision machining. (14 marks)

**OR**

16. Describe an optical system for monitoring of grinding wheel topography. (14 marks)

#### Module IV

17. Describe how process capability can be used as a planning metric for transition from one process stage to another. (14 marks)

OR

18. Discuss four levels of integration between the tasks of design, manufacturing and finishing. (14 marks)

#### Module V

19. With the help of a diagram explain CMP process. (14 marks)

OR

20. Explain the process of diamond turning with suitable diagrams. (14 marks)

### Syllabus

#### Module 1

Introduction to precision machining: Competitive drivers for precision machining. Definition of terms- accuracy, precision and resolution. Metrology and measurement- Abbe's principle. Measurement of dimension and angle- measurement of form- straightness, flatness and roundness. Measurement of surface roughness.

#### Module 2

Sources of error in precision machining: Mechanical errors- errors due to machine elements, thermal errors, Error due to compliance and vibration. Error budget- error budget flow chart- (elementary idea only). Role of kinematic design in precision. Principles of design and utilisation of bearings-aerostatic bearings.

#### Module 3

Sensors in precision machining: Classification of basic sensor types- overview of sensors in manufacturing- applications- AE based monitoring of grinding wheel dressing- fast AE RMS analysis of wheel condition monitoring (description only). Topographical mapping of grinding wheel. AE based monitoring of face milling.

**Module 4**

Process planning for precision machining: process planning basics-factors which influence precision-process capability-relationship between process variability and product specification- process capability as a planning metric.

**Module 5**

Precision machining processes: Diamond turning and milling, fly cutting diamond machine configuration- features of diamond machine tool design- applications. Configuration for conical circumferential milling- applications. Typical single point diamond tool geometry. Abrasive processes-fixed and loose. Nano grinding-Chemical mechanical Planarization (CMP)- precision manufacturing applications.

**Text Books and References**

1. David Dornfeld, Dae-Eun Lee, Precision Manufacturing, Springer, 2008
2. V.C. Venkatesh, Sudin Izman, Precision Engineering, Tata McGraw- Hill, 2007
3. Michael N. Morgan, Andrew Shaw, Otar Mgaloblishvili, Precision Machining VI, Transtech publications Ltd, Switzerland, 2012

**Course Contents and Lecture Schedule**

No.	Topic	No. of Lectures
1.1	Introduction to precision machining.	1
1.2	Philosophy of precision machine design	1
1.3	Competitive drivers for precision machining	2
1.4	Definition of terms- accuracy, precision and resolution	1
1.5	Metrology and measurement – Abbe's principle	1
1.6	Measurement of dimension and angle	1
1.7	Measurement of form- straightness, flatness and roundness	1
1.8	Measurement of surface roughness	1
2.1	Sources of error in precision machining	2
2.2	Mechanical errors – errors due to machine elements, thermal errors	2
2.3	Errors due to compliance and vibration	1
2.4	Error budget	1
2.5	Error budget flow chart	1
2.6	Role of kinematic design in precision	1
2.7	Principles of design and utilisation of bearings – Aerostatic bearings	1
3.1	Sensors in Precision Machining- classification	2
3.2	Overview of sensors and applications	1
3.3	AE based monitoring of grinding wheel dressing	1
3.4	Description of Fast AE RMS analysis of wheel condition monitoring	1
3.5	Topographical mapping of grinding wheel	1

3.6	AE based monitoring of face milling	1
4.1	Process planning for precision machining	2
4.2	Process planning basics	1
4.3	Factors influencing precision.	1
4.4	Process capability	2
4.5	Relationship between process variability and product specification	1
4.6	Process capability as a planning metric	1
5.1	Precision machining Processes – Diamond turning and milling	1
5.2	Fly cutting diamond machine configuration	1
5.3	Features of diamond machine tool design-applications	1
5.4	Configuration for conical circumferential milling- applications	1
5.5	Typical single point diamond tool geometry	1
5.6	Abrasive processes- fixed and loose	1
5.7	Nano grinding	1
5.8	Chemical Mechanical Planarization	1
5.9	Precision manufacturing applications	1

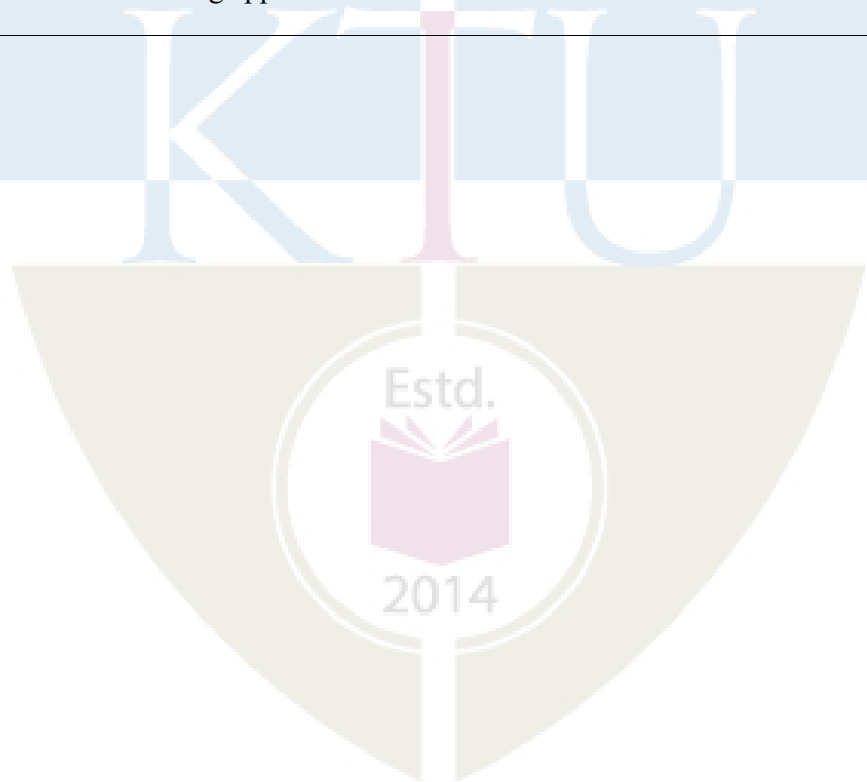

APJ ABDUL KALAM  
TECHNOLOGICAL  
UNIVERSITY

# **SEMESTER VIII**

KTU



CODE	COURSE NAME	CATEGORY	L	T	P	CREDIT
MET402	MECHATRONICS	PCC	2	1	0	3

**Preamble:** This course provides the mechanical systems used in Mechatronics and the Integration of mechanical, electronics, control and computer engineering in the design of mechatronics systems.

**Prerequisite:** NIL

**Course Outcomes:** After the completion of the course the student will be able to

CO Nos	Course Outcomes	Level of learning domain
CO 1	Explain the sensors and actuators used in mechatronics	2
CO 2	Design hydraulic and pneumatic circuits for automation.	6
CO 3	Explain the manufacturing processes used in MEMS	2
CO 4	Demonstrate the various components of a CNC machine	2
CO 5	Create a PLC program	6
CO 6	Explain the robotic sensors and vision system	2

#### Mapping of course outcomes with program outcomes

	PO 1	PO 2	PO 3	PO 4	PO 5	PO 6	PO 7	PO 8	PO 9	PO 10	PO 11	PO 12
CO 1	3	2	2									
CO 2	3	3	3		3							
CO 3	3	1	1									
CO 4	3	1	1									
CO 5	3	3	3		3							
CO 6	3	1	1									

#### Assessment Pattern

Bloom's Category	Continuous Assessment Tests		End Semester Examination
	1	2	
Remember			
Understand	40	40	70
Apply			
Analyse			
Evaluate			
Create	10	10	30

**Mark distribution**

<b>Total Marks</b>	<b>CIE</b>	<b>ESE</b>	<b>ESE Duration</b>
150	50	100	3 hours

**Continuous Internal Evaluation Pattern:**

Attendance	: 10 marks
Continuous Assessment Test (2 numbers)	: 25 marks
Assignment/Quiz/Course project	: 15 marks

**End Semester Examination Pattern:** There will be two parts; Part A and Part B. Part A contain 10 questions with 2 questions from each module, having 3 marks for each question. Students should answer all questions. Part B contains 2 questions from each module of which student should answer any one. Each question can have maximum 2 sub-divisions and carry 14 marks.

**Course Level Assessment Questions****Course Outcome 1 (CO1):**

1. Which type of sensor can be used for determining angular movement of a shaft?
2. What is the significance of grey scale in absolute encoders?
3. Which type of actuator can be used for a mechanical system?

**Course Outcome 2 (CO2)**

1. Explain the basic structure of a simple hydraulic circuit?
2. Explain the basic structure of a simple pneumatic circuit?
3. Design a hydraulic circuit for two hand operation of a hydraulic press?
4. Design a pneumatic circuit for the sequencing operation A+B+A-B-

**Course Outcome 3(CO3):**

1. Explain the LIGA process.
2. Explain the MEMS based gyroscope?
3. Explain the deposition-based MEMS manufacturing technique?

**Course Outcome 4 (CO4):**

1. Explain the working of ant frictional guideways?
2. Demonstrate suitable methods to achieve antifriction feed drive system?
3. Demonstrate suitable non-contact type measuring system that can be used in CNC?

**Course Outcome 5 (CO5):**

1. Discuss About various type of range finders used in robotics?
2. Discuss about various image accusation techniques used in robotics?
3. Discuss various image processing techniques used in robotics?

**Model Question Paper****MECHATRONICS - MET402****Max. Marks : 100****Duration : 3 Hours****PART - A****Answer all questions, each question carries 3 marks**

1. Explain the significance of grey codes in an absolute optical encoder?
2. Explain cushioning in pneumatic actuator?
3. Explain with a neat sketch working of a poppet valve.
4. What is meant by high aspect ratio machining? List any 2 methods of manufacturing used in it.
5. Differentiate between hydrostatic and hydro dynamic bearing used in CNC machines.
6. What is meant by stick slip phenomena in a frictional guideway?
7. Explain the XOR logic using suitable ladder diagram and truth table?
8. Explain the ladder diagram for a delay on timer circuit?
9. Differentiate between CCD and CID camera used in robots?
10. Discuss the functioning of a tactile sensors?

**PART -B****Answer one full question from each module.****MODULE - 1**

11. List and explain in detail the static and dynamic characteristics of a sensor (10 marks)

OR

12. a) Write a note on rotary actuators. (3 marks)
- b) Explain with a suitable diagram various component of a pneumatic system. (7 marks)

**MODULE - 2**

13. Develop a hydraulic circuit for the sequencing operation  $A+B+A-B$ ? (10 marks)

OR

14. Explain the working of MMS based accelerometer with a neat sketch? (8 marks)

**MODULE - 3**

15. a) What is meant by preloading? Explain in detail about preloading methods used in a recirculating ball screw (6 marks)
- b) Explain various load acting on a CNC machine structure (4 marks)

OR

16. Develop a mathematical model for a general fluid system (10 marks)

**MODULE – 4**

17. Two motors are to be controlled in a sequence. The second motor starts 30 seconds after the starting of first motor by a push switch. Develop a PLC ladder diagram for the following cases and describe the circuit.

Case (A): Only one motor operates at a time.

Case (B): Both the motor gets off together after 50 seconds. 3DP (10 marks)

OR

18 Explain the working of an automobile engine management system using suitable diagrams. Also explain its advantages over conventional automobile system (10 marks)

**MODULE – 5**

19 a) what is meant by image accusation? Illustrate the working of Charge Coupled Device for machine vision applications. (10 marks)

OR

- 20 a) Explain the histogram processing technique in image processing. (6 marks)  
b) What is meant by thresholding in image processing? (4 marks)

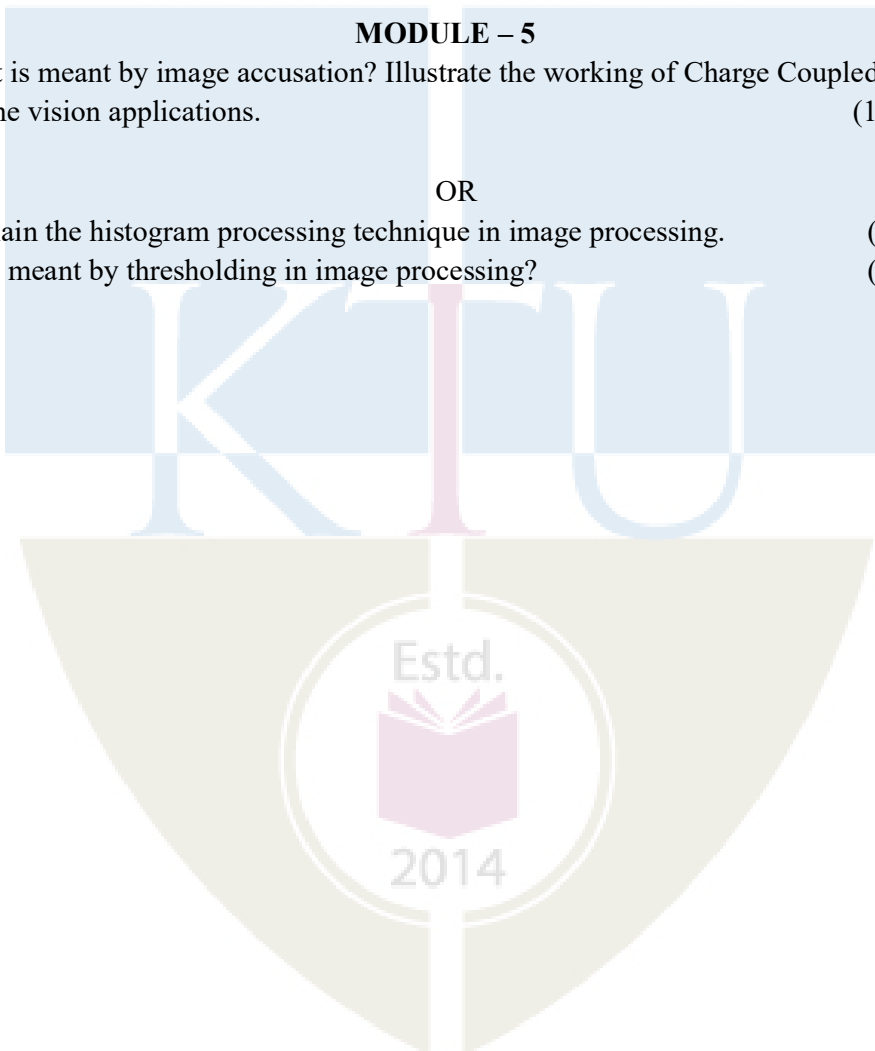

## SYLLABUS

### Module 1

Introduction to Mechatronics: Structure of Mechatronics system. Sensors - Characteristics - Temperature, flow, pressure sensors. Displacement, position and proximity sensing by magnetic, optical, ultrasonic, inductive, capacitive and eddy current methods. Encoders: incremental and absolute, gray coded encoder. Resolvers and synchros. Piezoelectric sensors. Acoustic Emission sensors. Principle and types of vibration sensors.

Actuators: Mechanical actuators, Electrical actuators, Hydraulic and Pneumatic actuators

### Module 2

Directional control valves, pressure control valves, process control valves. Rotary actuators. Development of simple hydraulic and pneumatic circuits using standard Symbols.

Micro Electro Mechanical Systems (MEMS): Fabrication: Deposition, Lithography, Micromachining methods for MEMS, Deep Reactive Ion Etching (DRIE) and LIGA processes. Principle, fabrication and working of MEMS based pressure sensor, accelerometer and gyroscope.

### Module 3

Mechatronics in Computer Numerical Control (CNC) machines: Design of modern CNC machines - Mechatronics elements - Machine structure: guide ways, drives. Bearings: anti-friction bearings, hydrostatic bearing and hydrodynamic bearing. Re-circulating ball screws, pre-loading methods. Re-circulating roller screws. Measuring system for NC machines - direct and indirect measuring system.

System modeling - Mathematical models and basic building blocks of general mechanical, electrical, fluid and thermal systems.

### Module 4

Typical elements of open and closed loop control systems. Adaptive controllers for machine tools. Programmable Logic Controllers (PLC) –Basic structure, input/ output processing. Programming: Timers, Internal Relays, Counters and Shift registers. Development of simple ladder programs for specific purposes.

Case studies of Mechatronics systems: Automatic camera, bar code reader, pick and place robot, automatic car park barrier system, automobile engine management system.

### Module 5

Mechatronics in Robotics-Electrical drives: DC, AC, brushless, servo and stepper motors. Harmonic drive. Force and tactile sensors. Range finders: ultrasonic and light-based range finders

Robotic vision system - Image acquisition: Vidicon, charge coupled device (CCD) and charge injection device (CID) cameras. Image processing techniques: histogram processing: sliding, stretching, equalization and thresholding.

### Text Books

1. Bolton W., Mechatronics: Electronic Control Systems in Mechanical and Electrical Engineering, Person Education Limited, New Delhi, 2007
2. Ramachandran K. P., G. K. Vijayaraghavan, M. S. Balasundaram, Mechatronics: Integrated Mechanical Electronic Systems, Wiley India Pvt. Ltd., New Delhi, 2008.
3. Saeed B. Niku, Introduction to Robotics: Analysis, Systems, Applications, Person Education, Inc., New Delhi, 2006.

### Reference Books

1. David G. Aldatore, Michael B. Histan, Introduction to Mechatronics and Measurement Systems, McGraw-Hill Inc., USA, 2003.
2. Gordon M. Mair, Industrial Robotics, Prentice Hall International, UK, 1998.
3. HMT, Mechatronics, Tata McGraw-Hill Publishing Company Ltd., New Delhi, 2004.
4. Vijay K. Varadan, K. J. Vinoy, S. Gopalakrishnan, Smart Material Systems and MEMS: Design and Development Methodologies, John Wiley & Sons Ltd., England, 2006.

### Course Contents and Lecture Schedule

No	Topic	No. of Lectures
<b>MODULE 1</b>		
1.1	Introduction to Mechatronics: Structure of Mechatronics system. Sensors - Characteristics	1
1.2	Temperature, flow, pressure sensors. Displacement, position and proximity sensing by magnetic, optical, ultrasonic, inductive, capacitive and eddy current methods.	2
1.3	Encoders: incremental and absolute, gray coded encoder.	1
1.4	. Resolvers and synchros. Piezoelectric sensors. Acoustic Emission sensors. Principle and types of vibration sensors.	1
1.5	Actuators: Mechanical actuators, Electrical actuators, Hydraulic and Pneumatic actuators	2
<b>MODULE 2</b>		
2.1	Directional control valves, pressure control valves, process control valves. Rotary actuators.	2
2.2	Development of simple hydraulic and pneumatic circuits using standard Symbols.	2
2.3	Micro Electro Mechanical Systems (MEMS): Fabrication: Deposition, Lithography, Micromachining methods for MEMS,	2
2.4	Deep Reactive Ion Etching (DRIE) and LIGA processes.	1
2.5	Principle, fabrication and working of MEMS based pressure sensor, accelerometer and gyroscope.	2
<b>MODULE 3</b>		
3.1	Mechatronics in Computer Numerical Control (CNC) machines: Design of modern CNC machines - Mechatronics elements - Machine structure: guide ways, drives. Bearings: anti-friction bearings, hydrostatic bearing and hydrodynamic bearing.	2
3.2	Re-circulating ball screws, pre-loading methods. Re-circulating roller screws. Measuring system for NC machines - direct and indirect measuring system.	2
3.3	System modeling - Mathematical models and basic building blocks of general mechanical & electrical system	1
3.4	Mathematical models and basic building blocks of general fluid and thermal systems	1

<b>MODULE 4</b>		
4.1	Typical elements of open and closed loop control systems. Adaptive controllers for machine tools. Programmable Logic Controllers (PLC) – Basic structure, input/ output processing.	<b>2</b>
4.2	Programming: Timers, Internal Relays, Counters and Shift registers. Development of simple ladder programs for specific purposes	<b>2</b>
4.3	Case studies of Mechatronics systems: Automatic camera, bar code reader, pick and place robot, automatic car park barrier system, automobile engine management system.	<b>2</b>
<b>MODULE 5</b>		
5.1	Mechatronics in Robotics-Electrical drives: DC, AC, brushless, servo and stepper motors. Harmonic drive.	<b>2</b>
5.2	Force and tactile sensors. Range finders: ultrasonic and light-based range finders	<b>2</b>
5.3	Robotic vision system - Image acquisition: Vidicon, charge coupled device (CCD) and charge injection device (CID) cameras.	<b>2</b>
5.4	Image processing techniques: histogram processing: sliding, stretching, equalization and thresholding.	<b>2</b>

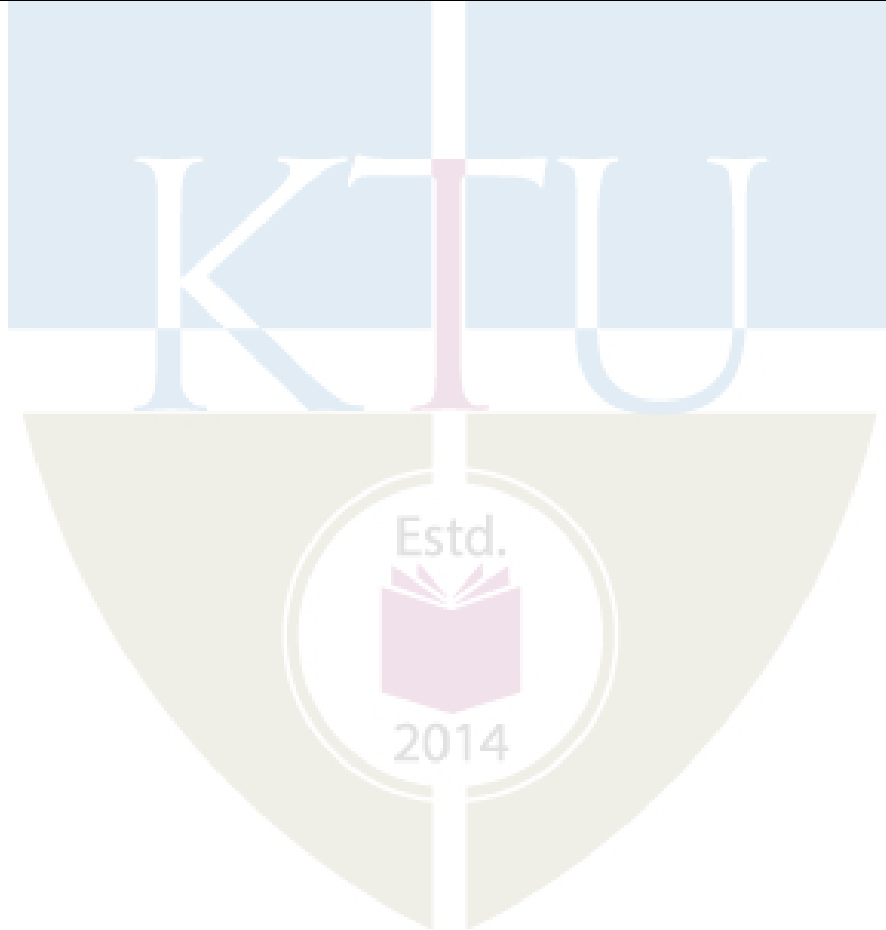

MET404	COMPREHENSIVE COURSE VIVA	CATEGORY	L	T	P	CREDIT
		PCC	1	0	0	1

**Preamble:** The objective of this Course viva is to ensure the basic knowledge of each student in the most fundamental core courses in the curriculum. The viva voce shall be conducted based on the core subjects studied from third to eighth semester. This course helps the learner to become competent in placement tests and other competitive examinations.

#### Guidelines

1. The course should be mapped with a faculty and classes shall be arranged for practicing questions based on the core courses listed in the curriculum.
2. The viva voce will be conducted by the same three member committee assigned for final project phase II evaluation. It comprises of Project coordinator, expert from Industry/research Institute and a senior faculty from a sister department.
3. The pass minimum for this course is 25.
4. The mark will be treated as internal and should be uploaded along with internal marks of other courses.
5. Comprehensive Viva should be conducted along with final project evaluation by the three member committee.

#### Mark Distribution

Total marks: 50, only CIE, minimum required to pass : 25 Marks



MED416	PROJECT PHASE II	CATEGORY	L	T	P	CREDIT
		PWS	0	0	12	4

**Preamble:** The course ‘Project Work’ is mainly intended to evoke the innovation and invention skills in a student. The course will provide an opportunity to synthesize and apply the knowledge and analytical skills learned, to be developed as a prototype or simulation. The project extends to 2 semesters and will be evaluated in the 7th and 8th semester separately, based on the achieved objectives. One third of the project credits shall be completed in 7th semester and two third in 8th semester. It is recommended that the projects may be finalized in the thrust areas of the respective engineering stream or as interdisciplinary projects. Importance should be given to address societal problems and developing indigenous technologies.

**Course Objectives**

- To apply engineering knowledge in practical problem solving.
- To foster innovation in design of products, processes or systems.
- To develop creative thinking in finding viable solutions to engineering problems.

**Course Outcomes [COs]:** After successful completion of the course, the students will be able to:

CO1	Model and solve real world problems by applying knowledge across domains (Cognitive knowledge level: <b>Apply</b> ).
CO2	Develop products, processes or technologies for sustainable and socially relevant applications (Cognitive knowledge level: <b>Apply</b> ).
CO3	Function effectively as an individual and as a leader in diverse teams and to comprehend and execute designated tasks (Cognitive knowledge level: <b>Apply</b> ).
CO4	Plan and execute tasks utilizing available resources within timelines, following ethical and professional norms (Cognitive knowledge level: <b>Apply</b> ).
CO5	Identify technology/research gaps and propose innovative/creative solutions (Cognitive knowledge level: <b>Analyze</b> ).
CO6	Organize and communicate technical and scientific findings effectively in written and oral forms (Cognitive knowledge level: <b>Apply</b> ).

**Mapping of course outcomes with program outcomes**

	PO1	PO2	PO3	PO4	PO5	PO6	PO7	PO8	PO9	PO10	PO11	PO12
CO1	2	2	2	1	2	2	2	1	1	1	1	2
CO2	2	2	2		1	3	3	1	1		1	1
CO3									3	2	2	1
CO4					2			3	2	2	3	2
CO5	2	3	3	1	2							1
CO6					2			2	2	3	1	1

<b>Abstract POs defined by National Board of Accreditation</b>			
<b>PO #</b>	<b>Broad PO</b>	<b>PO#</b>	<b>Broad PO</b>
PO1	Engineering Knowledge	PO7	Environment and Sustainability
PO2	Problem Analysis	PO8	Ethics
PO3	Design/Development of solutions	PO9	Individual and team work
PO4	Conduct investigations of complex problems	PO0	Communication
PO5	Modern tool usage	PO11	Project Management and Finance
PO6	The Engineer and Society	PO12	Lifelong learning

## PROJECT PHASE II

### Phase 2 Targets

- In depth study of the topic assigned in the light of the report prepared under Phase - I;
- Review and finalization of the approach to the problem relating to the assigned topic.
- Preparing a detailed action plan for conducting the investigation, including teamwork.
- Detailed Analysis/ Modeling / Simulation/ Design/ Problem Solving/Experiment as needed.
- Final development of product/ process, testing, results, conclusions and future directions.
- Preparing a paper for Conference Presentation/ Publication in Journals, if possible.
- Presenting projects in Project Expos conducted by the University at the cluster level and/ or state level as well as others conducted in India and abroad.
- Filing Intellectual Property Rights (IPR) if applicable.
- Preparing a report in the standard format for being evaluated by the Department Assessment Board.
- Final project presentation and viva voce by the assessment board including the external expert.

### Evaluation Guidelines & Rubrics

Total: 150 marks (Minimum required to pass: 75 marks).

- Project progress evaluation by guide: 30 Marks.
- Two interim evaluations by the Evaluation Committee: 50 Marks (25 marks for each evaluation).
- Final evaluation by the Final Evaluation committee: 40 Marks
- Quality of the report evaluated by the evaluation committee: 30 Marks

(The evaluation committee comprises HoD or a senior faculty member, Project coordinator and project supervisor. The final evaluation committee comprises of Project coordinator, expert from Industry/research/academic Institute and a senior faculty from a sister department).

### Evaluation by the Guide

The guide/supervisor must monitor the progress being carried out by the project groups on regular basis. In case it is found that progress is unsatisfactory it should be reported to the Department Evaluation Committee for necessary action. The presence of each student in the group and their involvement in all stages of execution of the project shall be ensured by the guide. Project evaluation by the guide: 30 Marks. This mark shall be awarded to the students in his/her group by considering the following aspects:

**Project Scheduling & Distribution of Work among Team members:** Detailed and extensive Scheduling with timelines provided for each phase of project. Work breakdown structure well defined. (5)

**Literature survey:** Outstanding investigation in all aspects. (4)

**Student's Diary/ Daily Log:** The main purpose of writing daily diary is to cultivate the habit of documenting and to encourage the students to search for details. It develops the students' thought process and reasoning abilities. The students should record in the daily/weekly activity diary the day to day account of the observations, impressions, information gathered and suggestions given, if any. It should contain the sketches & drawings related to the observations made by the students. The daily/weekly activity diary shall be signed after every day/week by the guide. (7)

**Individual Contribution:** The contribution of each student at various stages. (9)

**Completion of the project:** The students should demonstrate the project to their respective guide. The guide shall verify the results and see that the objectives are met. (5)



### EVALUATION RUBRICS for PROJECT Phase II: Interim Evaluation - 1

No.	Parameters	Marks	Poor	Fair	Very Good	Outstanding
2-a	Novelty of idea, and Implementation scope [CO5] [Group Evaluation]	5	The project is not addressing any useful requirement. The idea is evolved into a non-implementable one. The work presented so far is lacking any amount of original work by the team.	Some of the aspects of the proposed idea can be implemented. There is still lack of originality in the work done so far by the team. The project is a regularly done theme/topic without any freshness in terms of specifications, features, and/or improvements.	Good evidence of an implementable project. There is some evidence for the originality of the work done by the team . There is fresh specifications/features/improvements suggested by the team. The team is doing a design from fundamental principles, and there is some independent learning and engineering ingenuity.	The project has evolved into incorporating an outstandingly novel idea. Original work which is not yet reported anywhere else. Evidence for ingenious way of innovation which is also Implementable. Could be a patentable / publishable work.
			(0 – 1 Marks)	(2 – 3 Marks)	(4 Marks)	(5 Marks)
2-b	Effectiveness of task distribution among team members. [CO3] [Group Evaluation]	5	No task distribution of any kind. Members are still having no clue on what to do.	Task allocation done, but not effectively, some members do not have any idea of the tasks assigned. Some of the tasks were identified but not followed individually well.	Good evidence of task allocation being done, supported by project journal entries, identification of tasks through discussion etc. However, the task distribution seems to be skewed, and depends a few members heavily than others. Mostly the tasks are being followed by the individual members.	Excellent display of task identification and distribution backed by documentary evidence of team brainstorming, and project journal entries. All members are allocated tasks according to their capabilities, and as much as possible in an equal manner. The individual members are following the tasks in an excellent manner.
			(0 – 1 Marks)	(2 – 3 Marks)	(4 Marks)	(5 Marks)
2-c	Adherence to project schedule. [CO4] [Group Evaluation]	5	Little or no evidence of continued planning or scheduling of the project. The students did not stick to the plan what they were going to build nor plan on what materials / resources to use in the project. The students do not have any idea on the budget required even after the end of phase - I. No project journal kept or the journal.	There is some improvement in the primary plan prepared during phase I. There were some ideas on the materials /resources required, but not really thought out. The students have some idea on the finances required, but they have not formalized a budget plan. Schedules were not prepared. The project journal has no useful details on the project.	Good evidence of planning done and being followed up to a good extent after phase I. Materials were listed and thought out, but the plan wasn't followed completely. Schedules were prepared, but not detailed, and needs improvement. Project journal is presented but it is neither complete nor updated regularly.	Excellent evidence of enterprising and extensive project planning and follow-up since phase I. Continued use of project management/version control tool to track the project. Material procurement if applicable is progressing well. Tasks are updated and incorporated in the schedule. A well-kept project journal showed evidence for all the above, in addition to the interaction with the project guide.
			(0 - 1 Marks)	(2 - 3 Marks)	(4 Marks)	(5 Marks)

2-d	Interim Results. [CO6] [Group assessment]	5	There are no interim results to show.	The team showed some interim results, but they are not complete / consistent to the current stage, Some corrections are needed.	The interim results showed were good and mostly consistent/correct with respect to the current stage. There is room for improvement.	There were significant interim results presented which clearly shows the progress.
			(0 - 1 Marks)	(2 - 3 Marks)	(4 Marks)	(5 Marks)
2-e	Presentation [Individual assessment]	5	Very poor presentation and there is no interim results. The student has no idea about the project proposal.	Presentation is average, and the student has only a feeble idea about the team work.	Good presentation. Student has good idea about the team's project. The overall presentation quality is good.	Exceptionally good presentation. Student has excellent grasp of the project. The quality of presentation is outstanding.
			(0 - 1 Marks)	(2 - 3 Marks)	(4 Marks)	(5 Marks)
<b>Phase-II Interim Evaluation - 1 Total Marks: 25</b>						



### EVALUATION RUBRICS for PROJECT Phase II: Interim Evaluation – 2

No	Parameters	Marks	Poor	Fair	Very Good	Outstanding
2-f	Application of engineering knowledge [CO1] [Individual Assessment]	10	The student does not show any evidence of applying engineering knowledge on the design and the methodology adopted. The student's contribution in application of engineering knowledge in the project is poor.	The student appears to apply some basic knowledge, but not able to show the design procedure and the methodologies adopted in a comprehensive manner.	The student is able to show some evidence of application of engineering knowledge in the design and development of the project to good extent.	Excellent knowledge in design procedure and its adaptation. The student is able to apply knowledge from engineering domains to the problem and develop solutions.
			(0 – 3 Marks)	(4 – 6 Marks)	(7 - 9 Marks)	(10 Marks)
2-g	Involvement of individual members [CO3] [Individual Assessment]	5	No evidence of any Individual participation in the project work.	There is evidence for some amount of individual contribution, but is limited to some of the superficial tasks.	The individual contribution is evident. The student has good amount of involvement in core activities of the project.	Evidence available for the student acting as the core technical lead and has excellent contribution to the project.
			(0 - 1 Marks)	(2 - 3 Marks)	(4 Marks)	(5 Marks)
2-h	Results and inferences upon execution [CO5] [Group Assessment]	5	None of the expected outcomes are achieved yet. The team is unable to derive any inferences on the failures/ issues observed. Any kind of observations or studies are not made.	Only a few of the expected outcomes are achieved. A few inferences are made on the observed failures/issues. No further work suggested.	Many of the expected outcomes are achieved. Many observations and inferences are made, and attempts to identify the issues are done. Some suggestions are made for further work.	Most of the stated outcomes are met. Extensive studies are done and inferences drawn. Most of the failures are addressed and solutions suggested. Clear and valid suggestions made for further work.
			(0 - 1 Marks)	(2 - 3 Marks)	(4 Marks)	(5 Marks)
2-i	Documentation and presentation. [CO6] [Individual assessment]	5	The individual student has no idea on the presentation of his/her part. The presentation is of poor quality.	Presentation's overall quality needs to be improved.	The individual's presentation performance is satisfactory.	The individual's presentation is done professionally and with great clarity. The individual's performance is excellent.
			(0 - 1 Marks)	(2 - 3 Marks)	(4 Marks)	(5 Marks)

**Phase-II Interim Evaluation - 2 Total Marks: 25**

**EVALUATION RUBRICS for PROJECT Phase II: Final Evaluation**

No	Parameters	Marks	Poor	Fair	Very Good	Outstanding
2-j	Engineering knowledge. [CO1] [Group Assessment]	10	The team does not show any evidence of applying engineering knowledge on the design and the methodology adopted.	The team is able to show some of the design procedure and the methodologies adopted, but not in a comprehensive manner.	The team is able to show evidence of application of engineering knowledge in the design and development of the project to good extent. There is scope for improvement.	Excellent knowledge in design procedure and its adaptation. The team is able to apply knowledge from engineering domains to the problem and develop an excellent solution.
			(0 – 3 Marks)	(4 – 6 Marks)	(7 - 9 Marks)	(10 Marks)
2-k	Relevance of the project with respect to societal and/or industrial needs. [Group Assessment] [CO2]	5	The project as a whole do not have any societal / industrial relevance at all.	The project has some relevance with respect to social and/or industrial application. The team has however made not much effort to explore further and make it better.	The project is relevant to the society and/or industry. The team is mostly successful in translating the problem into an engineering specification and managed to solve much of it.	The project is exceptionally relevant to society and/or industry. The team has made outstanding contribution while solving the problem in a professional and/or ethical manner.
			(0 - 1 Marks)	(2 - 3 Marks)	(4 Marks)	(5 Marks)
2-i	Innovation / novelty / Creativity [CO5] [Group Assessment]	5	The project is not addressing any useful requirement. The idea is evolved into a non-implementable one. The work presented so far is lacking any amount of original work by the team.	Some of the aspects of the proposed idea appears to be practical. There is still lack of originality in the work done. The project is a regularly done theme/topic without any freshness in terms of specifications, features, and/or improvements.	Good evidence of an implementable project. There is some evidence for the originality of the work done by the team. There is fresh specifications/features/improvements suggested by the team. The team is doing a design from fundamental principles, and there is some independent learning and engineering ingenuity. Could be translated into a product / process if more work is done.	The project has evolved into incorporating an outstandingly novel idea. Original work which is not yet reported anywhere else. Evidence for ingenious way of innovation which is also Implementable. Could be a patentable publishable work.
			(0 - 1 Marks)	(2 - 3 Marks)	(4 Marks)	(5 Marks)
2-m	Quality of results / conclusions / solutions. [CO1] [Group Assessment]	10	None of the expected outcomes are achieved. The team is unable to derive any inferences on the failures/issues observed. Any kind of observations or studies is not made.	Only a few of the expected outcomes are achieved. A few inferences are made on the observed failures/issues. No further work suggested.	Many of the expected outcomes are achieved. Many observations and inferences are made, and attempts to identify the issues are done. Some suggestions are made for further work.	Most of the stated outcomes are met. Extensive studies are done and inferences drawn. Most of the failures are addressed and solutions suggested. Clear and valid suggestions made for further work.
			(0 – 3 Marks)	(4 – 6 Marks)	(7 - 9 Marks)	(10 Marks)

2-n	Presentation - Part I Preparation of slides. [CO6] [Group Assessment].	5	The presentation slides are shallow and in a clumsy format. It does not follow proper organization.	Presentation slides follow professional style formats to some extent. However, its organization is not very good. Language needs to be improved. All references are not cited properly, or acknowledged. Presentation slides needs to be more professional.	Presentation slides follow a good style format and there are only a few issues. Organization of the slides is good. Most of references are cited properly. The flow is good and team presentation is neatly organized. Some of the results are not clearly shown. There is room for improvement.	The presentation slides are exceptionally good. Neatly organized. All references cited properly. Diagrams/Figures, Tables and equations are properly numbered, and listed. Results/ inferences clearly highlighted and readable.
			(0 - 1 Marks)	(2 - 3 Marks)	(4 Marks)	(5 Marks)
	Presentation - Part II: Individual Communication [CO6] [Individual Assessment].	5	The student is not communicating properly. Poor response to questions.	The student is able to explain some of the content. The student requires a lot of prompts to get to the idea. There are language issues.	Good presentation/ communication by the student. The student is able to explain most of the content very well. There are however, a few areas where the student shows lack of preparation. Language is better.	Clear and concise communication exhibited by the student. The presentation is outstanding. Very confident and tackles all the questions without hesitation. Exceptional traits of communicator.
			(0 - 1 Marks)	(2 - 3 Marks)	(4 Marks)	(5 Marks)
<b>Phase-II Final Evaluation, Marks: 40</b>						



**EVALUATION RUBRICS for PROJECT Phase II: Report Evaluation**

Sl. No.	Parameters	Marks	Poor	Fair	Very Good	Outstanding
2-o	Report [CO6]	30	The prepared report is shallow and not as per standard format. It does not follow proper organization. Contains mostly unacknowledged content. Lack of effort in preparation is evident. References are not cited. Unprofessional and inconsistent formatting.	Project report follows the standard format to some extent. However, its organization is not very good. Language needs to be improved. All references are not cited properly in the report. There is lack of formatting consistency.	Project report shows evidence of systematic documentation. Report is mostly following the standard style format and there are only a few issues. Organization of the report is good. Mostly consistently formatted. Most of references/sources are cited, acknowledged properly.	The report is exceptionally good. Neatly organized. All references cited properly. Diagrams/Figures, Tables and equations are properly numbered, and listed and clearly shown. Language is excellent and follows professional styles. Consistent formatting and exceptional readability.
			(0 - 11 Marks)	(12 - 18 Marks)	(19 - 28 Marks)	(29 - 30 Marks)
<b>Phase - II Project Report Marks: 30</b>						

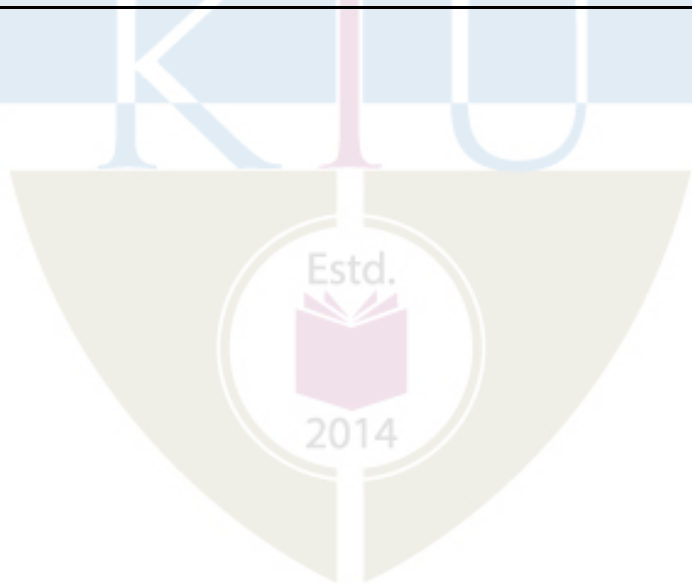

APJ ABDUL KALAM  
TECHNOLOGICAL  
UNIVERSITY

---

**SEMESTER VIII**

---

**PROGRAM ELECTIVE III**

---



CODE	COURSE NAME	CATEGORY	L	T	P	CREDIT
MET414	QUALITY MANAGEMENT	PEC	2	1	0	3

**Preamble:** This course is designed to facilitate the students to understand the concept and culture of total quality management. It empowers the students by inculcating the skills to use quality control techniques and other quality tools in solving quality-related problems and apply these principles in an industry. This course will also amalgamate their knowledge about the importance of customer satisfaction through desired quality at a competitive price.

**Prerequisite:** NIL

**Course Outcomes:** After the completion of the course the student will be able to

CO 1	To be conversant with important terms for quality management in organisations
CO 2	Have a complete theoretical and practical understanding of the contributions of Quality Gurus
CO 3	Demonstrate knowledge of the underlying principles of strategic quality management
CO 4	Identify various human dimensions of TQM
CO 5	Implement different tools and techniques in TQM
CO 6	Identify core and extended modules of ISO 9000 family of standards

#### Mapping of course outcomes with program outcomes

	PO 1	PO 2	PO 3	PO 4	PO 5	PO 6	PO 7	PO 8	PO 9	PO 10	PO 11	PO 12
CO 1	3					2					3	3
CO 2	2										2	2
CO 3	2	2	2						3		3	3
CO 4	3					3			3		3	3
CO 5	2	3	3	2	2				2		3	2
CO 6					2	2	1	1	2	3	3	1

#### Assessment Pattern

Bloom's Category	Continuous Assessment Tests		End Semester Examination (in %)
	1 (in %)	2 (in %)	
Remember	20	20	20
Understand	60	40	40
Apply	20	40	40
Analyse			
Evaluate			
Create			

**Mark distribution**

<b>Total Marks</b>	<b>CIE Marks</b>	<b>ESE Marks</b>	<b>ESE Duration</b>
150	50	100	3 hours

**Continuous Internal Evaluation Pattern:**

Attendance	: 10 marks
Continuous Assessment Test (2 numbers)	: 25 marks
Assignment/Quiz/Course project	: 15 marks

**End Semester Examination Pattern:** There will be two parts; Part A and Part B. Part A contain 10 questions with 2 questions from each module, having 3 marks for each question. Students should answer all questions. Part B contains 2 questions from each module of which student should answer any one. Each question can have maximum 2 sub-divisions and carry 14 marks.

**Course Level Assessment Questions****Course Outcome 1 (CO1):**

1. Distinguish between quality control and inspection.
2. What are the TQM axioms?
3. What are the enablers of total quality?

**Course Outcome 2 (CO2)**

1. Describe the Deming approach to TQM.
2. List out Crosby's fourteen steps for quality improvement.
3. Describe Juran's quality trilogy.

**Course Outcome 3(CO3):**

1. Define strategic quality management.
2. With examples, describe the classification of quality costs.
3. Describe the concepts of Kaizen approach.

**Course Outcome 4(CO4):**

1. What is meant by employee empowerment with respect to total quality management?
2. What are self managing teams?

3. Describe the importance of leadership in TQM

**Course Outcome 5 (CO5):**

1. “X and R charts always go hand in hand”. Elaborate.
2. What are the measures of Central tendency and dispersion?
3. Describe the principles of cause and effect diagram.

**Course Outcome 6 (CO6):**

1. Enumerate the benefits of ISO certification.
2. What are the benefits of quality auditing?
3. Enumerate the steps to be followed by a manufacturing organization to obtain ISO 9001 certification

**Model Question Paper**

**APJ ABDUL KALAM TECHNOLOGICAL UNIVERSITY  
EIGHTH SEMESTER B.TECH DEGREE EXAMINATION**

**Course Code: MET414**

**Course Name: QUALITY MANAGEMENT**

**Max. Marks: 100**

**Duration: 3 Hours**

**PART A**

**Answer ALL questions, each carries 3 marks.**

1. Define the term” Quality control”.
2. What are the enablers of total quality?
3. Describe the concept of Quality Function Deployment
4. What are the obstacles to achieving successful strategic quality management?
5. What is meant by employee empowerment?
6. Describe the importance of leadership in TQM
7. Describe the principles of cause and effect diagram.
8. Describe the procedure to be followed in a brain storming meeting.
9. Explain the clause in ISO 9001 associated with resource management.
10. What are the benefits of quality auditing?

**PART B**

*(Answer one full question from each module, each question carries 14 marks)*

**Module-1**

11. a) Compare Juran and Deming approaches (7)  
 b) Explain the characteristics of Total Quality Management. (7)
- OR
- 12 a) Explain the three TQM axioms. (12)  
 b) Define Quality Planning. (2)

**Module-2**

13. Describe the steps to be followed to integrate quality into strategic management journey of an organization. (14)
- OR
14. (a) Enumerate the objectives and key principles of lean manufacturing paradigm. (7)  
 (b) Compare traditional and lean manufacturing paradigms. (7)

**Module-3**

15. What are self managing teams? What are the benefits and problems associated with them? Indicate the key steps to be followed to implement them in organizations. (14)

OR

16. What are the ingredients for success for a quality director? What are the activities to be carried out by a quality director towards assisting upper management with strategic management (14)

**Module-4**

17. With the aid of an example, describe the principles of cause and effect diagram. (14)

OR

18. Following are the data on the quality costs incurred in a manufacturing company in a month:

Title of the quality cost	Amount in Rupees
Product audits	1,000

Scrap Disposal	50,000
Concessions and Downgrading	40,000
Calibration	2,000
Quality planning	500
Manufacturing losses	30,000
System failure	40,000
Test materials	5,000
Training	2,000
Customer returns	25,000

Classify the above quality costs into preventive, appraisal and failure costs. Conduct Pareto analysis and comment on the results. Suggest a proposal with anticipation on the quality costs observable in future. (14)

#### Module-5

19. Describe the steps to be followed for conducting a quality audit. (14)

OR

20. Enumerate the steps to be followed by a manufacturing organization to obtain ISO 9001 certification. (14)



## Syllabus

### Module 1

Introduction to Quality Engineering - Definitions of the terms - quality, quality planning, quality control, quality assurance, quality management, Total Quality Management (TQM)- overview on TQM - the TQM axioms - consequences of total quality- Barriers to TQM- Deming approach to TQM – Juran’s quality trilogy- Crosby's fourteen steps for quality improvement

### Module 2

Strategic Quality Management: Cost of Quality- Customer satisfaction- Quality Function Deployment (QFD)- Integrating quality into strategic management - quality and the management cycle- obstacles to achieving successful strategic quality management- supplier selection- Concepts of 5S, Six Sigma, Lean, Kaizen

### Module 3

Human dimensions of TQM – Top management commitment- Leadership for TQM- Change management- resources for quality activities - training for quality –Employee involvement, motivation empowerment- teamwork- self managing teams - role of the quality director

### Module 4

Supporting Tools, Activities And Techniques in TQM Projects : Affinity diagram - brainstorming - cause and effect analysis - process flow chart – check sheets- Scatter diagram - Pareto chart- Histogram and fundamentals of statistics - Control charts for improving process capability- Taguchi’s robust design- Total Productive maintenance- Failure Mode and Effect Analysis

### Module 5

Quality System: ISO 9000 family of standards- ISO 9001:2000 model, quality management system- management responsibility- resource management- product realisation- measurement analysis and improvements- ISO 14000 family of standards- Quality auditing- types and benefits.

### Text Books

1. Besterfield Dale H. , Besterfield Carol, Besterfield Glen H., Besterfield Mary, Urdhwareshe Hemant, Urdhwareshe Rashmi, “Total Quality Management (TQM) 5e”, Pearson Education, 2018.
2. Subburaj Ramasamy, “Total Quality Management”, McGraw Hill Education,, 2017.
3. Dr. K.C. Arora, “Total Quality Management”, S K Kataria and Sons, 2013.
4. Suganthi, L and Anand A Samuel, “Total Quality Management”, Prentice Hall India Learning Private Limited, 2009.

5. Juran J M and Gryna, F M, "Quality Planning and Analysis - From Product Development through Use", Tata McGraw Hill Publishing Limited, New Delhi, Third Edition, 2004.

### Reference Books

1. Logothetics N, "Managing for Total Quality - From Deming to Taguchi and SPC", Prentice Hall Ltd., New Delhi, 1997.
2. Deming W E, "Out of the Crisis," MIT Press, Cambridge, MA, 1982.
3. Juran J M and Juran on "Leadership for Quality" An Executive Handbook, The Free Press, New York, 1989.
4. Salor J H, "TQM-Field Manual," McGraw Hill, New York, 1992.
5. Crosby P B, "Quality is Free" McGraw Hill, New York, 1979.

### Course Contents and Lecture Schedule

No	Topic	No. of Lectures
1	<b>Introduction to Quality Engineering</b>	
1.1	Definitions of the terms - quality, quality planning, quality control, quality assurance, quality management	2
1.2	Total Quality Management (TQM)- overview on TQM - the TQM axioms - consequences of total quality- Barriers to TQM	2
1.3	Deming approach to TQM - Juran quality trilogy- Crosby's fourteen steps for quality improvement	3
2	<b>Strategic Quality Management</b>	
2.1	Cost of Quality- Customer satisfaction- Quality Function Deployment (QFD)	2
2.2	Integrating quality into strategic management - quality and the management cycle- obstacles to achieving successful strategic quality management	2
2.3	Supplier selection	1
2.4	Concepts of 5S, Six Sigma, Lean, Kaizen	3
3	<b>Human dimensions of TQM</b>	
3.1	Top management commitment- Leadership for TQM- Change management	2
3.2	Resources for quality activities - training for quality	1
3.3	Employee involvement, motivation, empowerment	3
3.3	Teamwork- self managing teams - role of the quality director	1
4	<b>Supporting Tools, Activities And Techniques in TQM Projects</b>	
4.1	Affinity diagram - brainstorming	1
4.2	Cause and effect analysis - process flow chart – check sheets- Scatter diagram - Pareto chart	3
4.3	Histogram and fundamentals of statistics -	1
4.4	Control charts for improving process capability-	2
4.5	Taguchi's robust design- Total Productive maintenance- Failure	2

	Mode and Effect Analysis	
5	<b>Quality System</b>	
5.1	ISO 9000 family of standards	1
5.2	ISO 9001 model, quality management system- management responsibility- resource management- product realisation- measurement analysis and improvements	2
5.3	ISO 14000 family of standards	1
5.4	Quality auditing- types and benefits	1

ATJ ABDOL KALAM  
TECHNOLOGICAL  
UNIVERSITY

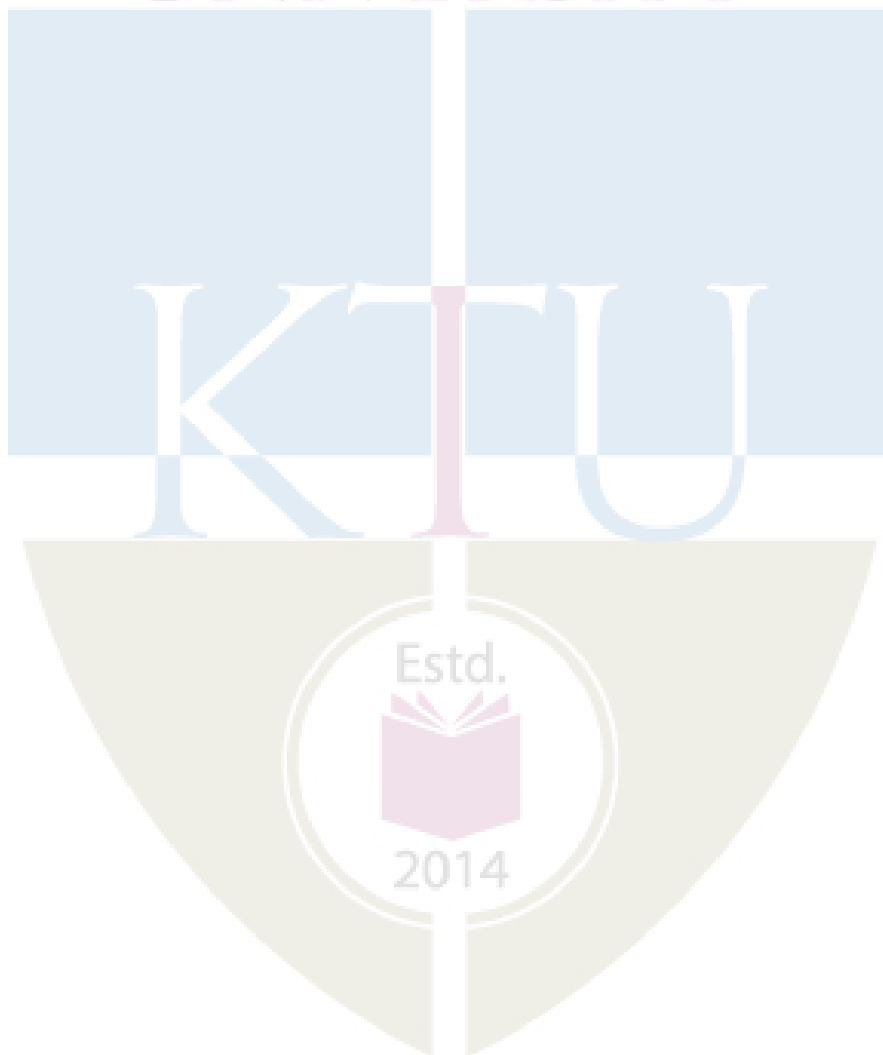

CODE	COURSE NAME	CATEGORY	L	T	P	CREDIT
MET424	INDUSTRIAL HYDRAULICS	PEC	2	1	0	3

**Preamble:** This course covers the fundamentals of operating principles, configuration features, functionalities, and applications of various elements in typical hydraulic systems

**Prerequisite:** NIL

**Course Outcomes:** After the completion of the course the student will be able to

CO 1	Identify the basic elements of a fluid power system
CO 2	Describe the properties of a hydraulic fluid
CO 3	Distinguish between different types of pumps
CO 4	Explain the operation and features of various hydraulic actuators
CO 5	Describe the purpose, construction and operation of various control valves
CO 6	Develop a hydraulic circuit to perform a desired function

**Mapping of course outcomes with program outcomes**

	PO 1	PO 2	PO 3	PO 4	PO 5	PO 6	PO 7	PO 8	PO 9	PO 10	PO 11	PO 12
CO 1	3	2										
CO 2	3	2										
CO 3	3	2										
CO 4	3	2										
CO 5	3	2										
CO 6	3	2										

**Assessment Pattern**

Bloom's Category	Continuous Assessment Tests		End Semester Examination
	1	2	
Remember	10	10	10
Understand	20	20	20
Apply	20	20	70
Analyse			
Evaluate			
Create			

**Mark distribution**

<b>Total Marks</b>	<b>CIE</b>	<b>ESE</b>	<b>ESE Duration</b>
150	50	100	3 hours

**Continuous Internal Evaluation Pattern:**

Attendance : 10 marks  
 Continuous Assessment Test (2 numbers) : 25 marks  
 Assignment/Quiz/Course project : 15 marks

**End Semester Examination Pattern:** There will be two parts; Part A and Part B. Part A contain 10 questions with 2 questions from each module, having 3 marks for each question. Students should answer all questions. Part B contains 2 questions from each module of which student should answer any one. Each question can have maximum 2 sub-divisions and carry 14 marks.

**Course Level Assessment Questions****Course Outcome 1 (CO1):**

1. Differentiate between hydraulic and pneumatic system
2. Discuss the advantages of fluid power
3. Describe key applications of fluid power
4. Identify the graphical symbols used for various components of fluid power system

**Course Outcome 2 (CO2):**

1. Describe the properties of hydraulic fluids
2. Discuss the primary functions of hydraulic fluid

**Course Outcome 3 (CO3):**

1. Explain various types of pumps
2. Compare the various performance factors of gear, vane and piston pumps
3. Explain pressure intensifiers
4. Describe various types of accumulators

**Course Outcome 4(CO4):**

1. Describe the construction and design features of hydraulic cylinders
2. Identify the various types of hydraulic cylinder cushioning and mountings
3. Explain various types of hydraulic motors

**Course Outcome 5 (CO5):**

1. Explain the construction, working and applications of various hydraulic control valves

2. Discuss the construction features and functions of conductors

**Course Outcome 6 (CO6):**

1. Illustrate different hydraulic circuits
2. Describe the applications of accumulator

**Model Question Paper**

**Total Pages:**

Reg No.: \_\_\_\_\_ Name: \_\_\_\_\_

**APJ ABDUL KALAM TECHNOLOGICAL UNIVERSITY**  
**EIGHTH SEMESTER B.TECH MINOR DEGREE EXAMINATION,**  
**COURSE CODE: MET424**

**COURSE NAME: INDUSTRIAL HYDRAULICS**

Max. Marks: 100

Duration: 3 Hours

**PART A**

*(Answer all questions; each question carries 3 marks)*

		Marks
1	Comment on the differences between pneumatic and hydraulic fluid power systems	3
2	Differentiate between viscosity and viscosity index. Under what conditions is viscosity index important?	3
3	Derive an expression for the actual volumetric displacement of the vane pump in terms of the dimensions of the pump components	3
4	Discuss about the influence of pressure, size and speed on pump noise level	3
5	Sketch and explain Tandem cylinder	3
6	List the advantages of a hydraulic motor over an electric motor	3
7	Discuss why all fluid power systems are fitted with a pressure relief valve	3
8	Explain the construction features and function of flexible hoses	3
9	Explain the purpose of a regenerative circuit	3
10	Write a note on accumulator as hydraulic shock absorber	3

**PART B**

*(Answer one full question from each module, each question carries 14 marks)*

**Module -1**

11	a) With the help of a neat sketch, explain the basic components of a hydraulic system	8
	b) Explain the advantages and disadvantages of a hydraulic system	6
12	a) Explain the desirable properties of hydraulic fluids	6
	b) Sketch and describe a rectangular flat-topped reservoir fitted with basic accessories.	8

**Module -2**

13	a) Explain with a neat sketch, the working of a gear pump. Also obtain an expression for its volumetric efficiency	8
----	--------------------------------------------------------------------------------------------------------------------	---

- b) With a neat sketch, explain the working of a lobe pump. 6
- 14 a) With neat sketch, explain how vane pump can be made to work as a variable displacement pump without changing the speed of the prime mover 7
- b) Explain the construction and operation of piston-type accumulators 7

### Module -3

- 15 a) Describe end cushion provided in hydraulic cylinder with neat sketch 6
- b) With the help of a neat sketch, explain the construction and working of a balanced vane motor. Give its main advantage over vane motor. 7
- 16 a) Sketch a semi-rotary vane motor. Derive an expression for its torque capacity 6
- b) With a neat diagram, explain the construction and working of in line piston motor (Bent axis design). 8

### Module -4

- 17 a) Give the classification of check valves and explain the construction and working of pilot-operated check valve, giving the necessary drawing. 7
- b) Explain with neat sketch, how three way and four way direction control valve operate 7
- 18 a) With a neat sketch, explain the construction and working of pressure reducing valve 7
- b) With a neat sketch, explain spool type direction control valve used to control double acting cylinder 7

### Module -5

- 19 a) Describe with a neat circuit diagram, fail-safe system that provide overload protection for system components. 6
- b) Draw the sequencing circuit for operating two double acting cylinders in a sequence in both strokes. Use appropriate component for the circuit & explain its working for a hydraulic system 8
- 20 a) With a neat circuit diagram, explain the working of a meter out circuit for controlling the speed of a cylinder 6
- b) The table of a surface grinding machine needs automatic reciprocating motion. Draw a hydraulic circuit to achieve this motion 8

## Syllabus

### Module 1

Introduction to fluid power: - Classification of fluid power systems- Basic components, Symbols & circuits of a hydraulic and pneumatic system, Properties of fluids

Hydraulic fluids and fluid handling components: - Fluid for hydraulic systems- Hydraulic fluids reservoirs- Hydraulic seals- Filters and Strainers

### Module 2

Hydraulic pumps:- Classification and pumping theory- Principle of working and constructional details of vane pump, gear pumps, radial and axial plunger pumps- Pump performance

Hydraulic pressure intensifiers, Power storage devices –Accumulators

### Module 3

Hydraulic actuators:- Linear hydraulic actuators-Types, Cylinder cushions, Rotary actuators – Classification, construction and working of gear, vane, axial and radial piston motors- Limited rotation hydraulic actuators- Hydraulic motor performance

### Module 4

Hydraulic control valves:-Classification of control valves- Directional control valves- Pressure control valves- Flow control valves- Servo valves

Hydraulic conductors

### Module 5

Hydraulic circuits:- Control of single and double -acting hydraulic cylinder, Regenerative circuit- Pump-unloading circuit, Double-pump hydraulic system, Pressure intensifier circuit, Counter balance valve application, Hydraulic cylinder sequencing circuits, Automatic cylinder reciprocating system, Locked cylinder using pilot check valves, Cylinder synchronizing circuits- Speed control of a hydraulic cylinder, Bleed-off flow control circuit- Fail-safe circuits- Hydraulic motor breaking system, Hydraulic circuit examples with accumulator

### Text Books

Anthony Esposito, Fluid Power with Applications, Pearson Education India, 2013 NIL

### Reference Books

1. J. J. Pipenger, Tyler Gregory Hicks, Industrial Hydraulics, McGraw Hill, 1979
2. Herbert E. Merritt, Hydraulic Control Systems, John Wiley & Sons, 1967

3. S R Majumdar, Oil hydraulic systems: Principles and Maintenance, McGraw Hill Education, 2017
4. Qin Zhang, Basics of hydraulic systems, CRC Press, 2018

### Course Contents and Lecture Schedule

No	Topic	No. of Lectures
1	<b>Introduction to fluid power systems</b>	
1.1	Introduction to fluid power – Classification of fluid power systems, Hydraulics and pneumatics systems, Hydrostatic and hydrodynamic Systems, Advantages, disadvantages and applications of fluid power	1
1.2	Basic components, symbols & circuits of a hydraulic and pneumatic system, Comparison between hydraulic and pneumatic systems, Comparison of different power systems	2
1.3	Properties of fluids- Density, Specific weight, Specific volume and Specific gravity- Pressure, head and force- Pascal's law and its applications-Bulk modulus-Viscosity and viscosity index	1
1.4	Hydraulic fluids and fluid-handling components:-Fluid for hydraulic systems-Functions of hydraulic fluid, desired properties of hydraulic fluid, Types of hydraulic fluids, Additives and their purposes, Factors influencing the selection of a fluid	1
1.5	Hydraulic fluids reservoirs- Functions, Design and constructional features, Sizing of the reservoir	1
1.6	Hydraulic seals- O-rings, Compression packings, piston cup packings, piston rings and wiper rings, Seal materials-Filters and Strainers - Types of filters, Beta Ratio of filters	1
2	<b>Hydraulic pumps</b>	
2.1	Hydraulic pumps: Classification and pumping theory, Gear pump- Construction and working of external gear pump, Advantages and disadvantages, Theoretical flow rate	1
2.2	Construction and working of Internal gear pump, Lobe pump, Gerotor pumps and Screw pump	1
2.3	Construction and working of Vane pump, Advantages and disadvantages ,Theoretical flow rate, Variable displacement vane pump- Balanced vane pump, Advantages and disadvantages	1
2.4	Piston pump- Axial and radial design, Axial piston pump (Bent-axis design, Swash-plate-type piston pump, and Radial piston pump	1
2.5	Pump performance-Volumetric efficiency, Mechanical efficiency and Overall efficiency, Pump performance curve, Pump noise and Pump selection	1
2.6	Hydraulic pressure intensifier:-axial-piston style single and	1

	double-acting hydraulic pressure intensifiers	
2.7	Power storage devices -Accumulators: Types-Weight loaded or gravity type, Spring loaded type and Gas loaded (Nonseparator and separator) type	1
3	<b>Hydraulic actuators</b>	
3.1	Linear hydraulic actuators-Types-Single acting and double acting cylinders, Ram cylinders, Telescopic cylinders and Tandem cylinders	1
3.2	Cylinder cushions, Cushioning pressure, Cylinder force, Velocity and Power, Acceleration and deceleration of cylinder loads	1
3.3	Cylinder mountings, Mechanics of hydraulic cylinder loadings-First class, Second class and Third class lever systems	1
3.4	Rotary actuators – Classification, Construction and working of gear, vane, balanced vane, axial (Swash plate and Bent-axis design) and radial piston motors, Limited rotation hydraulic actuators	2
3.5	Theoretical torque, power, flow rate, hydraulic motor performance- volumetric efficiency, mechanical efficiency and overall efficiency, Performance characteristics of hydraulic motor, Comparison of gear, vane and piston motor, Simple numerical problems	2
4	<b>Hydraulic control valves</b>	
4.1	Hydraulic control valves-Classification of control valves, Directional control valves-symbolic representation, constructional features of poppet, sliding spool, rotary spool valves, Manual, mechanical, solenoid and pilot operated DCV, shuttle valve, and check valves-Two way, Three way, and Four way valves-Applications	2
4.2	Pressure control valves – types, Simple pressure-relief valve, Compound pressure-relief valve, Pressure-reducing valve, Unloading valve, Counterbalance valve and Pressure-sequence valve- Applications	2
4.3	Flow control valves – Functions of flow control valves, Factors that determine the flow rate across an orifice or a restrictor, compensated and non-compensated FCV, needle valve, temperature compensated, pressure compensated, pressure and temperature compensated FCV, symbolic representation.	1
4.4	Servo valves-Mechanical-hydraulic servo valve, Electrohydraulic servo valve, Proportional control valves	1
4.5	Hydraulic conductors- Conductor sizing, Pressure rating of conductors, Steel pipes, Steel tubing, Plastic conductors and Flexible hoses, Pressure losses in hydraulic conduits	1
5	<b>Hydraulic circuits</b>	
5.1	Control of single and Double -acting hydraulic cylinder,	1

	Regenerative circuit- Expression for the cylinder extending speed	
5.2	Pump-Unloading Circuit, Double-pump hydraulic system, Pressure intensifier circuit, Counter balance valve application	1
5.3	Hydraulic cylinder sequencing circuits, Automatic cylinder reciprocating system	1
5.4	Locked cylinder using pilot check valves, Cylinder synchronizing circuits- Parallel and series	1
5.5	Speed control of a hydraulic cylinder-meter-in and meter-out circuit, Meter-in and meter-out flow control of both strokes, Bleed-off flow control circuit	1
5.6	Fail-Safe circuits- Protection from inadvertent cylinder extension and fail-safe overload protection	1
5.7	Hydraulic motor breaking system, Hydraulic circuit examples with accumulator- Accumulator as an auxiliary power source, Accumulator as a leakage compensator, Accumulator as an emergency power source, Accumulator as a shock absorber	1

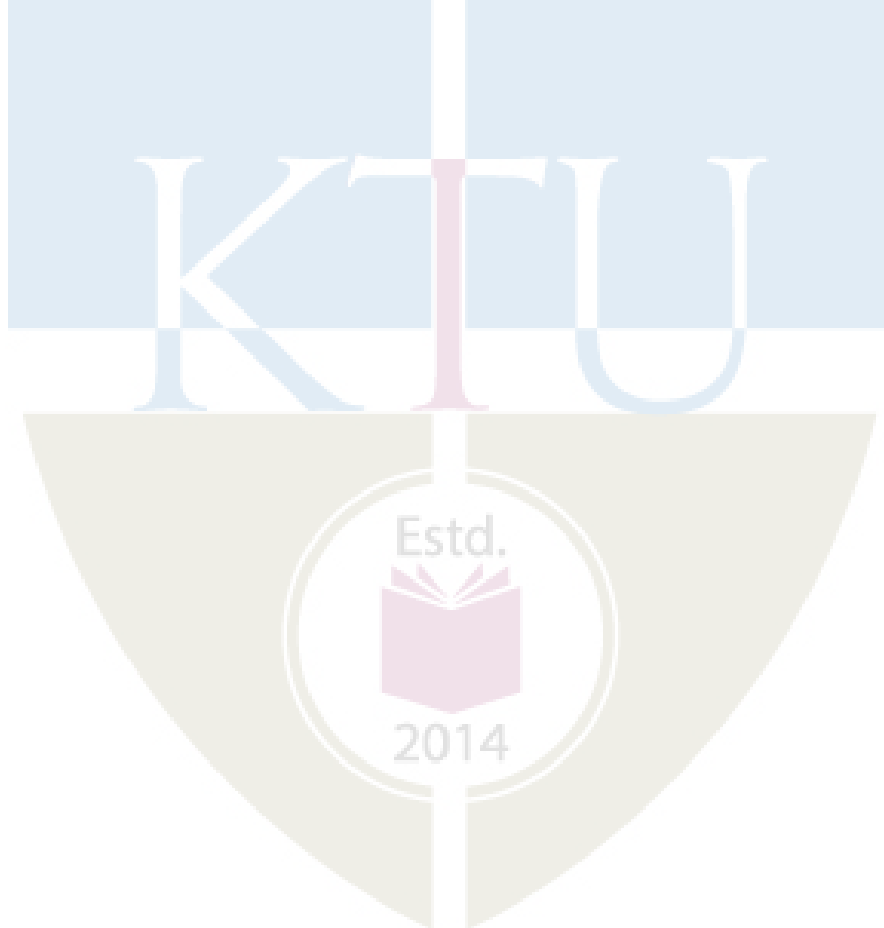



**Assessment Pattern**

Bloom's Category	Continuous Assessment Tests		End Semester Examination
	1	2	
Remember			
Understand	20	20	30
Apply	30	30	70
Analyse			
Evaluate			
Create			

**Mark distribution**

Total Marks	CIE	ESE	ESE Duration
150	50	100	3 hours

**Continuous Internal Evaluation Pattern:**

Attendance	: 10 marks
Continuous Assessment Test (2 numbers)	: 25 marks
Assignment/Quiz/Course project	: 15 marks

**End Semester Examination Pattern:** There will be two parts; Part A and Part B. Part A contain 10 questions with 2 questions from each module, having 3 marks for each question. Students should answer all questions. Part B contains 2 questions from each module of which student should answer any one. Each question can have maximum 2 sub-divisions and carry 14 marks.

**Course Level Assessment Questions****Course Outcome 1 (CO1):**

1. Derive the expression for membrane stresses in axisymmetric shell structure under internal pressure
2. Derive the expression for dilation in cylindrical and spherical pressure vessels under internal pressure
3. Explain the conditions for buckling in ellipsoidal shells and discuss the remedies

**Course Outcome 2 (CO2)**

1. Derive the Lamé's equations of stresses in thick cylinder under internal pressure
2. Find out the stress pattern developed in case of built up cylinders under a given interference

after assembly

3. What are thermal stresses in a pressure vessel and how they are evaluated

**Course Outcome 3(CO3):**

1. Explain the design steps in the design of tall cylindrical vessel under wind load
2. Explain with neat sketches the supports used in the case of vertical tall self-supported cylindrical vessels
3. Explain with sketches, various stresses developed in a saddle supported horizontal pressure vessel

**Course Outcome 4 (CO4):**

1. Derive the expression for critical buckling pressure for cylinder under external pressure
2. Explain with sketches the support design for pipes under external pressure
3. Explain the design curves for design of cylinders under both external pressure and compressive axial loading

**Course Outcome 5 (CO5):**

1. Explain the flexibility analysis of piping system
2. what is meant by modes of fracture? What is stress intensity factor
3. Explain failure assessment diagram and its usage

**Model Question Paper**

**APJ ABDUL KALAM TECHNOLOGICAL UNIVERSITY  
EIGHTH SEMESTER B. TECH DEGREE EXAMINATION  
Course Code: MET 434  
Course Name: PRESSURE VESSEL AND PIPING DESIGN**

**Max. Marks: 100**

**Duration: 3 Hours**

**PART – A**

**(ANSWER ALL QUESTIONS, EACH QUESTION CARRIES 3 MARKS)**

**Part-A**

1. Explain the stresses developed in a conical cylinder under internal pressure?
2. Derive the expression for dilation of a spherical shell under internal pressure?
3. Explain with sketches the stress pattern in a built-up cylinder after assembly?
4. Derive the expression for internal pressure for the full cross section yielding of a cylinder?
5. Explain with sketches, any two types of supports used for tall cylindrical vessels?
6. What are the different sections of ASME pressure vessel code?
7. Explain with sketches, stiffener support for pipe under external pressure?
8. Explain the design curves for pipe under both external and axial compressive loading?

9. What is meant by flexibility analysis?  
 10. What is meant by modes of fracture?

(10X3=30)

**PART – B****(ANSWER ONE FULL QUESTION FROM EACH MODULE)****MODULE – 1**

11. (a) Derive the general expression for stress equilibrium in an axisymmetric shell under internal pressure (6 marks)  
 (b) Derive the expression for membrane stresses in an elliptical shell and bring out the condition for local buckling (8 marks)

OR

12. (a) Derive the expression for stresses developed in a thin cylinder under internal pressure (6 marks)  
 (b) Derive the expression for membrane stresses developed in a torus under internal pressure (8 marks)

**MODULE – 2**

13. (a) A short Thick cylinder with 1000 mm internal diameter and 1300mm outside diameter subjected to an internal pressure of 40 MPa. Determine the location and magnitude of maximum tangential, radial, shear stresses induced. Find also the dilation of its inner and outer radii. (10 marks)  
 (b) Sketch the variation of stresses across the thickness of thick cylinder under internal pressure (4 marks)

OR

14. (a) A steel tube of 240 mm external diameter is shrunk on another steel tube of 80 mm internal diameter. Diameter of junction is 160mm. The interference before shrinking is 0.08 mm. Find the tangential stress at outer surface of inner tube (ii) the tangential stress at the inner surface of the outer tube and (iii) radial stress at the junction after assembly.  $E=200$  GPa (6 marks)  
 (b) Derive the expression for the internal pressure for intermittent yielding of cylindrical pressure vessels? (8 marks)

**MODULE – 3**

15. (a) Explain the design procedure of a tall vessel under wind load as per ASME code? (8 marks)

- (b) Explain with sketches, various supports used in case of tall vessel? (6 marks)

**OR**

16. (a) Explain the procedure followed in the case of tall vessel under seismic load? (8 marks)  
 (b) Explain with sketches, various supports used in case of horizontal pressure vessels under internal pressure? (6 marks)

**MODULE – 4**

17. (a) Derive the critical buckling pressure for a circular ring under external pressure? (8 marks)  
 (b) Explain the procedure for pipe sizing under external pressure? (6 marks)

**OR**

18. (a) Discuss the classification of cylinders for design for buckling as per ASME code. (6 marks)  
 (b) Explain the following terms (i) factors A & B for vacuum design (ii) Buckling coefficients (iii) effect of imperfections on buckling strength ? (8 marks)

**MODULE – 5**

19. (a) Discuss various methods to increase flexibility in a piping system. (6 marks)  
 (b) A thick walled cylinder with 300 MPa internal pressure, internal diameter 300mm external diameter 600 mm is having a semi elliptical defect 10mm deep on the inside surface. The aspect ratio of the flaw is 0.1. Check whether vessel is satisfactory from fracture point of view.  $K_{IC} = 180 \text{ MPa}\sqrt{m}$ . (8 marks)

**OR**

- 20.(a) Explain the following (i) Displacement stress range (ii) stress range reduction factor (ii) Sustained and occasional loads. (7 marks)  
 (b) Explain (i) fracture toughness (ii) leak before break (iii) through thickness/surface flaws. (7 marks)

## Syllabus

### Module 1

Pressure vessel – Terminology – Types of loads – Types of pressure- Stresses in pressure vessels – Dilation of pressure vessels – Membrane stress analysis of vessel shell components  
Cylindrical shells, spherical shells, torus, conical head, elliptical head  
Bending of circular plates under uniform pressure load with simply supported and clamped edges (no derivation)

### Module 2

Stresses in thick walled cylinders – Lamé's equation for internal and external pressure  
Shrink-fit stresses in Built up cylinders, autofrettage of thick cylinders, Thermal stresses and their significance

### Module 3

Design of pressure vessels- shell and support design of tall vessel under wind and seismic load  
Shell and support design of horizontal vessels  
Familiarization with relevant ASME codes and standard practices in pressure vessel design

### Module 4

Buckling -Elastic buckling of cylinders or pipes under external pressure- Pipe sizing under external pressure- Design of Stiffeners  
Buckling under combined compressive pressure and axial load

### Module 5

Pipe stress Analysis -allowable displacement stress range for expected cyclic life-stress intensification factor and flexibility factor-Flexibility Analysis (Analysis as per clause 119.7.1 in Code ASME B31.1/closure 319.4.1 in ASME B31.3 only)  
Fracture based design of pressure vessels- modes of fracture-stress intensity factor -through thickness and surface cracks in pressure vessels (mode-I only)-fracture toughness-leak before break-failure assessment diagram

### Text Books

1. John F. Harvey, "Theory and Design of Pressure Vessels" CBS Publisher and Distributors
2. Brownell, L. E., and Young, E. H., "Process Equipment Design", John Wiley and Sons
3. Somnath Chathopadhyay, "Pressure Vessels Design and practice", C. R. C Press
4. Prashant Kumar, "Elements of fracture mechanics", McGraw Hill Education India

### Reference Books

1. Henry H. Bender, "Pressure Vessels Design hand book"
2. ASME Pressure Vessel Codes Section VIII, 2006
3. Dennis Moss, "Pressure Vessel Design Manual" Gulf publishing, 2003

4. J. Phillip Ellenberger, "Pressure Vessels: ASME Code Simplified", ASME
5. "American standard code for pressure piping, B 31.1", ASME.
6. Smith P, "Fundamentals of Piping Design", Elsevier
7. ASME Pressure Vessel and Boiler code, Section VIII Div. 1, 2, and 3", ASME
8. T. L Anderson "Fracture Mechanics: Fundamentals and applications" Taylor & Francis
9. D. Broek, "Elementary Engineering Fracture Mechanics", Kluwer Academic Publications

### Course Contents and Lecture Schedule

No	Topic	No. of Lectures
1	Design of thin pressure vessels	
1.1	Membrane stresses in general axisymmetric shell under internal pressure	3
1.2	Stresses and dilation in various kinds of components	2
1.3	Bending plates	2
2	<b>Design of thick pressure vessels</b>	
2.1	Stresses in thick walled cylinders – Lamé's equation - Shrink fit stresses in built up cylinders in Built up cylinders	3
2.2	Autofrettage in cylinders	2
2.3	Thermal stresses and significance	2
3	<b>Vertical and horizontal vessel design</b>	
3.1	Design of tall vertical shell structure and its supports	3
3.2	Design of shell and supports for horizontal vessels	3
3.3	Familiarization with standards and codes	2
4	<b>Buckling Analysis</b>	
4.1	Derivation of critical buckling pressure under external pressure	2
4.2	Pipe sizing and stiffener support design	3
4.3	Combined circumferential and axial buckling design	2
5	<b>Flexibility analysis and fracture design</b>	
5.1	Pipe stress and flexibility analysis	2
5.2	Fracture fundamentals	2
5.3	SIFs, leak before break and failure assessment diagram	3

CODE	COURSE NAME	CATEGORY	L	T	P	CREDIT
MET444	DATA ANALYTICS FOR ENGINEERS	PEC	2	1	0	3

**Preamble:** The student will understand the techniques to analyse different types of data, characterize it and can apply them to make decision modelling process more intelligent.

**Prerequisite:** Nil

**Course Outcomes:** After the completion of the course the student will be able to

CO 1	Explain different data analysis techniques
CO 2	Discuss the concepts behind the descriptive analytics and predictive analytics of data
CO 3	Familiarize with Big Data and its sources
CO 4	Illustrate different visualization techniques in data analysis

#### Mapping of course outcomes with program outcomes

	PO 1	PO 2	PO 3	PO 4	PO 5	PO 6	PO 7	PO 8	PO 9	PO 10	PO 11	PO 12
CO 1	3	3	3	1					1			2
CO 2	3	3	3	3					1			1
CO 3	3	3	3	1		1			1			1
CO 4	3	3	3	3								

#### Assessment Pattern

Bloom's Category	Continuous Assessment Tests		End Semester Examination
	1	2	
Remember	10	10	30
Understand	30	30	40
Apply	10	10	30
Analyse			
Evaluate			
Create			

**Mark distribution**

<b>Total Marks</b>	<b>CIE</b>	<b>ESE</b>	<b>ESE Duration</b>
150	50	100	3 hours

**Continuous Internal Evaluation Pattern:**

Attendance	: 10 marks
Continuous Assessment Test (2 numbers)	: 25 marks
Assignment/Quiz/Course project	: 15 marks

**End Semester Examination Pattern:** There will be two parts; Part A and Part B. Part A contain 10 questions with 2 questions from each module, having 3 marks for each question. Students should answer all questions. Part B contains 2 questions from each module of which student should answer any one. Each question can have maximum 2 sub-divisions and carry 14 marks.

**Course Level Assessment Questions****Course Outcome 1 (CO1):**

1. Explain the different types of prediction errors.
2. What is the need for sampling? Explain about different sampling methods.
3. Compare and contrast analysis and reporting in data analytics with suitable example

**Course Outcome 2 (CO2)**

1. Differentiate descriptive and predictive analysis technique.
2. Explain how attribute selection is carried out in decision tree induction.
3. Write different steps in Apriori algorithm used for finding frequent item sets.

**Course Outcome 3(CO3):**

1. Explain 3V's in big data analytics
2. List the different sources of bigdata.
3. With suitable example, give the difference between Business intelligence and data analytics.

**Course Outcome 4 (CO4):**

1. Discuss file system used for big data analysis.
2. Explain how recommender systems help in big data analysis.
3. Explain different techniques used for data visualization,

**Model Question Paper****APJ ABDUL KALAM TECHNOLOGICAL UNIVERSITY****VIII SEMESTER B.TECH EXAMINATION****MET444 DATA ANALYTICS FOR ENGINEERS****PART A****Answer all questions, each carries 3 marks**

1. Explain how significance level affects inferences drawn from data.
2. Define the term correlation between data points.
3. Differentiate classification and prediction.
4. State the different activation functions used in neural networks.
5. Give a brief description about how to perform descriptive analysis in a dataset.
6. Explain frequent item sets in association rule mining with example ?
7. Define bigdata.
8. List the challenges in big data acquisition
9. Explain the term social media analytics.
10. What is the significance of scatter plot matrix?

**PART B****Answer any one Question from each module. Each question carries 14 Marks****Module I**

11. Give the significance of resampling technique. Explain the different types of resampling techniques.
12. Describe the process of hypothesis technique with the help of a suitable example.

**Module II**

13. Illustrate regression analysis in predictive modelling.
14. Explain how principal components are extracted using PCA.

**Module III**

15. Differentiate K-means and hierarchical clustering techniques with suitable example.
16. Describe market-based model used in descriptive analysis.

**Module IV**

17. With the help of a neat diagram, describe data analytics lifecycle.
18. a. Describe the characteristics of Big data?
- b. Summarize the challenges and applications of big data analytics

**Module V**

19. What is HDFS? How does it handle Big Data?
20. Illustrate and explain the concept of Map Reduce framework

**Syllabus****Module 1 (7 hours)**

Introduction to Data Analysis - Evolution of Analytic scalability, analytic processes and tools, Analysis vs reporting - Modern data analytic tools. Statistical concepts: Sampling distributions, re-sampling, statistical inference, prediction error.

**Module 2 (7 hours)**

Predictive Analytics – Regression, Decision Tree, Neural Networks. Dimensionality Reduction - Principal component analysis

**Module 3 (7 hours)**

Descriptive Analytics - Mining Frequent item sets - Market based model – Association and Sequential Rule Mining - Clustering Techniques – Hierarchical – K- Means

**Module 4 (6 hours)**

Introduction to Big data framework - Fundamental concepts of Big Data management and analytics - Current challenges and trends in Big Data Acquisition

**Module 5 (8 hours)**

Popular Big Data Techniques and tools- Map Reduce paradigm and the Hadoop system- Applications Social Media Analytics, Recommender Systems- Fraud Detection

**Text Books**

1. EMC Education Services, Data Science and Big Data Analytics: Discovering, Analyzing, Visualizing and Presenting Data. John Wiley & Sons, 2015.
2. Jaiwei Han, Micheline Kamber, “Data Mining Concepts and Techniques”, Elsevier, 2006.
3. Michael Berthold, David J. Hand, Intelligent Data Analysis, Springer, 2007.2.

## Reference Books

1. Bart Baesens," Analytics in a Big Data World: The Essential Guide to Data Science and its Business Intelligence and Analytic Trends", John Wiley & Sons, 2013  
Challenges and Future Prospects, Springer, 2014.

## Course Contents and Lecture Schedule

No	Topic	No. of Lectures
<b>Module 1</b>		
1.1	Introduction to Data Analysis - Evolution of Analytic scalability	1
1.2	Analytic processes and tools	2
1.3	Analysis vs reporting - Modern data analytic tools	2
1.4	Statistical concepts: Sampling distributions, re-sampling, statistical inference, prediction error.	2
<b>Module 2</b>		
2.1	Predictive Analytics – Regression	2
2.2	Decision Tree	2
2.3	Neural Networks	1
2.4	Dimensionality Reduction - Principal component analysis	2
<b>Module 3</b>		
3.1	Descriptive Analytics - Mining Frequent item sets	2
3.2	Market based model	2
3.3	Association and Sequential Rule Mining	1
3.4	Clustering Techniques – Hierarchical	1
3.5	K- Means	1
<b>Module 4</b>		
4.1	Introduction: Fundamental concepts of Big Data management and analytics	1
4.2	Data Analytics Lifecycle Overview	2
4.3	Current challenges and trends in Big Data Acquisition	2
<b>Module 5</b>		
5	Popular Big Data Techniques and tools	1
5.1	Map Reduce paradigm	2
5.2	Hadoop system	2
5.3	Applications Social Media Analytics, Recommender Systems- Fraud Detection	2
5.4	Data Visualization techniques-overview	1

CODE	COURSE NAME	CATEGORY	L	T	P	CREDIT
MET454	INDUSTRIAL TRIBOLOGY	PEC	2	1	0	3

**Preamble:** The need for structural integrity of the surfaces of components is an essential requirement from the point of view of reliability of industrial components. Surfaces need to possess special properties so to prevent material loss, and to perform with minimal energy losses by way of friction. Surface treatment methods and prudent lubrication strategies coupled with testing-equipment/probes for conducting the tribological investigations form the basic aspects of tribological management in an industry. This course is meant to introduce the basic aspects of tribology, which a practising engineer or an engineer-analyst working in this area would require.

**Prerequisite:** Nil

**Course Outcomes:** After the completion of the course the student will be able to

CO 1	Apply Surface characterisation techniques for tribological investigations
CO 2	Explain theories of friction.
CO 3	Apply theories of wear for industrial problems.
CO 4	Explain Lubrication methods employed in Industrial scenarios.
CO 5	Explain Surface Coating techniques for industrial applications.

#### Mapping of course outcomes with program outcomes

	PO 1	PO 2	PO 3	PO 4	PO 5	PO 6	PO 7	PO 8	PO 9	PO 10	PO 11	PO 12
CO 1	3	2	1		3							
CO 2	3	2	1									
CO 3	3	2	1									
CO 4	3	2					1					
CO 5	3	2	1									

#### Assessment Pattern

Bloom's Category	Continuous Assessment Tests		End Semester Examination
	1	2	
Remember			
Understand	30	30	80
Apply	20	20	20
Analyse			
Evaluate			
Create			

**Mark distribution**

<b>Total Marks</b>	<b>CIE</b>	<b>ESE</b>	<b>ESE Duration</b>
150	50	100	3 hours

**Continuous Internal Evaluation Pattern:**

Attendance	: 10 marks
Continuous Assessment Test (2 numbers)	: 25 marks
Assignment/Quiz/Course project	: 15 marks

**End Semester Examination Pattern:** There will be two parts; Part A and Part B. Part A contain 10 questions with 2 questions from each module, having 3 marks for each question. Students should answer all questions. Part B contains 2 questions from each module of which student should answer any one. Each question can have maximum 2 sub-divisions and carry 14 marks.

**Course Level Assessment Questions****Course Outcome 1 (CO1):**

1. Realize the importance of tribology in mechanical engineering design.
2. Introduce tribology as a Surface Science.
3. Introduce the student to surface characterisation.
4. Learn some specific methods for physical and chemical characterisation of surfaces.

**Course Outcome 2 (CO2)**

1. Define coefficient of friction.
2. Learn an equipment to measure friction at the interface of a tribological pair.
3. Analyse different regimes of lubrication in terms of the Stribeck curve.
4. Learn some aspects of the theory of hydrodynamic lubrication
5. Learn the plowing and adhesion theories of friction

**Course Outcome 3(CO3):**

1. Define Wear, and methods of quantifying wear.
2. Learn theories of wear.

3. Learn about (i) Four Ball Tester and (ii) Pin-on-disk tester equipment to quantify wear.
4. Discuss wear and friction aspects, in common mechanical engineering scenarios.

**Course Outcome 4 (CO4):**

1. Introduce methods of classifying lubricants.
2. Learn the use of different lubricants for different industrial applications.
3. Learn about additives in industrial lubricants.
4. Create awareness related to environmental aspects while using lubricants.

**Course Outcome 5 (CO5):**

1. Introduction to surface treatments for better tribological performance.
2. Learn some specific methods employed in surface engineering for industrial applications.
3. Introduction to maintenance of tribological components and diagnostic methods for health assessment of bearings.

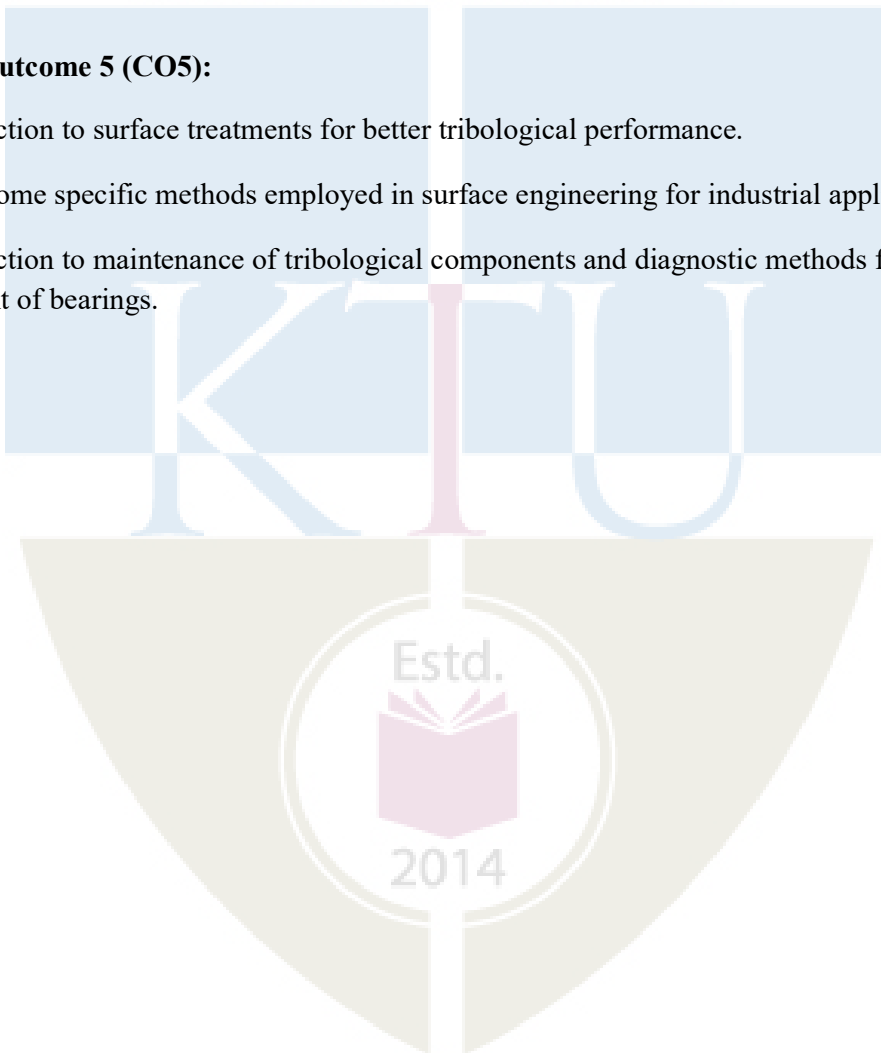

**Model Question Paper****MODEL QUESTION PAPER****APJ ABDUL KALAM TECHNOLOGICAL UNIVERSITY****EIGHTH SEMESTER B.TECH DEGREE EXAMINATION****COURSE CODE : MET454 COURSE NAME : INDUSTRIAL TRIBOLOGY****MAX. MARKS : 100****DURATION : 3 HOURS****PART – A****(ANSWER ALL QUESTIONS, EACH QUESTION CARRIES 3 MARKS)**

1. Write a short note on surface failure modes of machine components.
2. Enumerate few roughness parameters and their significance.
3. Explain the Stribeck diagram with the aid of a typical sketch.
4. Explain the *film-thickness-parameter* used to demarcate boundary lubrication regime.
5. Differentiate between fatigue wear and fretting wear.
6. What is running-in? How is it taken care of in the case of new automobiles?
7. What are extreme pressure lubricants? Make a short note on one method of testing their effectiveness.
8. Write a short note on SAE classification of lubricants.
9. Make a short note on coatings for metal cutting tools.
10. Write a short note on the tribological maintenance of roller chains and wire ropes in industry.

**PART – B****(ANSWER ONE FULL QUESTION FROM EACH MODULE)****MODULE – 1**

11. (a) Differentiate between (i) backscattered and (ii) secondary images as obtained from a SEM and when is one imaging type preferred over the other? If you want to image surface relief on a surface undergone wear, which type would you use? Why? (7 Marks)
- (b) On the same surface, if you want to analyse the distribution of phases on it, which of the above modes should be used? If an element-wise gross estimation of the metallic composition of the transfer layer formed on the surface is to be obtained, can it be made possible within a SEM? How is it realized? Explain the phenomena. (7 Marks)

OR

12. (a) Compare finding the chemical composition of the surface layer using (i) Energy Dispersive X-ray (EDX) analysis and (ii) X-ray photo-electron spectroscopy. When will you prefer one method over the other? (5 Marks)

(b) Compare roughness characterization using (i) mechanical stylus interferometry and (ii) optical interferometry. Discuss the merits and de-merits of each method. (5 Marks)

(c) Write short notes on Fractal characterisation of surfaces (ii) Bearing- area-curve (4 Marks)

### MODULE – 2

13. Derive the Reynolds' one dimensional bearing lubrication equation which expresses the pressure-gradient in terms of entraining velocity and film thickness factors. What are the simplifying assumptions involved in the derivation? How can this equation be used to determine the load carrying capacity of a hydrodynamic bearing? Plot the radial pressure distribution in the case of a cylindrical journal in a long hydrodynamic bearing. (14 Marks)

OR

14. (a) Compare theories of friction. (5 Marks)

(b) Describe method to visualize and lubricant film and make measurements, in a laboratory experiment. (7 Marks)

(c) Viscosity of the lubricant is not a significant parameter under boundary lubrication conditions-discuss. (2 Marks)

### MODULE – 3

15. (a) Derive the Archard's wear equation. What is the usual range of values for Archard's wear coefficient? (5 Marks)

(b) Discuss methods of quantifying wear (2 Marks)

(c) Compare wear theories (7 marks)

OR

16. (a) Are friction and wear always correlated? Discuss (4 Marks)

(b) Compare and contrast pin-on-disk testing and four-ball-wear-testing (6 Marks)

(c) Write a short note on improving wear resistance of cylinder liners in engines. (4 Marks)

### MODULE – 4

17. (a) Make short notes on the following terms in the context of liquid lubricants: (i) Viscosity Index (ii) ISO viscosity grades (iii) SAE viscosity grades (iv) pour point depressants (v) Anti Wear (AW) and Extreme pressure (EP) additives (vi) Bio-degradability (vii) Eco-toxicity (14 Marks)

OR

18. (a) Metal working fluids have functions different from that of usual tribological fluids used in industry- discuss. (3 Marks)
- (b) What are the factors limiting the applicability of vegetable oils for tribological applications in automobiles. (2 Marks)
- (c) Discuss methods for engine oil testing (3 Marks)
- (d) Explain Environmental impact assessment related to lubricating oils (3 Marks)
- (e) Explain the classification of engine oils (3 Marks)

**MODULE – 5**

- 19 (a) Explain different methods used for testing of coatings (4 Marks)
- (b) Briefly describe about the application of engineering coatings in aircraft industry (4 Marks)
- (c) Differentiate between PVD and CVD processes with practical examples from industry applications (6 Marks)

OR

- 20 (a) What are signs of bearing failure? Explain a diagnostic method of monitoring bearing health? (7 Marks)
- (b) Discuss improvements in Cylinder-liner technologies for improved tribological performance in IC engines. (7 Marks)



## Syllabus

### Module 1 (7 Hours)

Tribology as a Surface Science- Tribological considerations in design of machine elements, and industrial maintenance - surface failure of machine components-Physical and chemical characterization of surfaces-Surface roughness- tools for roughness characterization- Industrial norms in roughness quantification/characterization-surface finish symbols- Characterization of surface morphology – The Scanning Electron Microscope- backscattered and secondary imaging- X-ray dispersive analysis-. X-ray photo-electron spectroscopy and chemical characterization of surface films.

### Module 2 (7 Hours)

Friction-coefficient of friction- Stribeck curve-Lubrication regimes- Film thickness parameter- Fundamentals of hydrodynamic lubrication - Hydrodynamic pressure profile- Visualization and Measurement of film thickness in well lubricated contacts. Boundary lubrication-plowing and adhesion components-Pin-on-plate arrangement to measure friction. Theories of friction

### Module 3 (7 Hours)

Wear – wear of metals-wear of polymers- Types of wear: adhesive wear-abrasive wear-corrosive wear-fretting wear- quantification of wear- wear debris analysis. Pin-on-disk machine and the Four Ball Tester. Friction and wear in the context of internal combustion engines, Bearings, Gears, cams and tappets, and in metal machining.

### Module 4 (8 Hours)

Lubricants: Classification according to Carbon distribution-Viscosity Index-Viscosity Grades and their choice for various applications-Engine oil viscosity classification. Selection of industrial Lubricating oils. Metal working lubricants. Types of additives in lubricants for improved tribological performance. Environmental aspects and sustainability aspects related to use and disposal of lubricating oils, recycling.

### Module 5 (7 Hours)

Surface Engineering: Thermal Diffusion Methods(carburizing,Nitriding, Nitro-carburising, boriding, chromizing) –Methodical Methods for coating development-PVD Methods-CVD Methods-Electrochemical deposition-Thermal spraying.

Bearings-Classification of Bearings-Bearing materials-Bearing maintenance, diagnostic maintenance of Tribological components and considerations in IC engines and automobile parts, roller chains and wire ropes.

### Text Books

1. Prasanta Sahoo, “Engineering Tribology”, PHI, New Delhi, 2005.
2. John Williams, “Engineering Tribology”, Illustrated edition, Cambridge University Press, 2005.

3. R.D. Arnell, P. B. Davies, J. Halling, T. L. Whomes, “Tribology: Principles and Design Applications “, 1991.

### Reference Books

1. Theo Mang, Kirsten Bobzin, and Thorsten Bartels, “Industrial Tribology- Tribosystems, Friction, Wear and Surface Engineering, Lubrication”, Wiley-VCH; First edition, 2011.
2. B. Bhushan,” Principles and Application of Tribology”, Wiley, Second Edition, 2013.
3. G. W. Stachowiak and A. W. Batchelor, “Engineering Tribology”, Butterworth-Heinemann, Second revised edition, 2000.

### Course Contents and Lecture Schedule

No	Topic	No. of Lectures
1	<b>Module-1</b>	<b>7</b>
1.1	Importance of Tribology in design of machine elements	1 Hour
1.2	Surface roughness- Industrial norms in roughness quantification- surface finish symbols	1 Hour
1.3	Tools for roughness characterization-	1 Hour
1.4	The Scanning Electron Microscope-	1 Hours
1.5	backscattered and secondary imaging- X-ray dispersive analysis	1 Hours
1.6	X-ray photo-electron spectroscopy and chemical characterization and surface films.	2 hours
2	<b>Module-2</b>	<b>7</b>
2.1	Coefficient of friction and Pin-on-plate arrangement to measure friction.	1 Hour
2.2	Stribeck curve-Lubrication regimes- Film thickness parameter	1 Hour
2.3	Fundamentals of hydrodynamic lubrication - Hydrodynamic pressure profile	2 Hours
2.4	Visualization and Measurement of film thickness in well lubricated contacts	1 Hour
2.5	Boundary lubrication-plowing and adhesion components	1 Hour
2.6	Theories of friction	1 Hour
3	<b>Module-3</b>	<b>7</b>
3.1	Wear of metals	1 Hour
3.2	Types of wear	1 Hours
3.3	Quantification of wear	1 Hour
3.4	Wear of polymers	1 Hour

3.5	Pin-on-disk machine and the Four Ball Tester.	1 Hour
3.6	Friction and wear in the context of internal combustion engines, Bearings, Gears, cams and tappets, and in metal machining.	2 Hours
4	<b>Module-4</b>	<b>8</b>
4.1	Classification of liquid lubricants according to Carbon distribution-	1 Hour
4.2	Viscosity Index-Viscosity Grades and their choice for various applications	2 Hours
4.3	Engine oil viscosity classification	1 Hour
4.4	Selection of industrial Lubricating oils. Metal working lubricants.	2 Hours
4.5	Types of additives in lubricants for improved tribological performance	1 Hour
4.6	Environmental aspects related to use and disposal of lubricating oils, recycling.	1 Hour
5	<b>Module-5</b>	<b>7</b>
5.1	Carburizing, Nitriding, Nitro-carburising, boriding, chromizing	2 Hours
5.2	PVD-CVD-Electrochemical deposition-Thermal spraying	2 Hours
5.3	Bearings-Classification of Bearings-Bearing materials-	1 Hour
5.4	Diagnostic maintenance of Tribological components	1 Hour
5.5	Maintenance of gear boxes, roller chains and wire ropes.	1 Hour

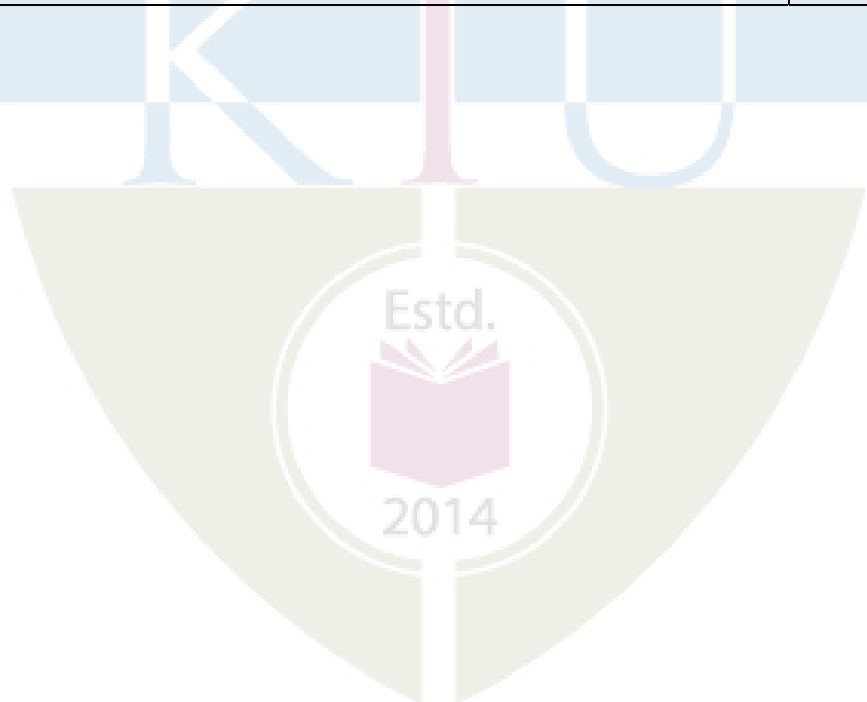

CODE	COURSE NAME	CATEGORY	L	T	P	CREDIT
MET464	MICRO AND NANO MANUFACTURING	PEC	2	1	0	3

**Preamble:** This course serves to enable the learners to understand the underlying principles, processes and applications with regard to broader areas of micro manufacturing and nanotechnology. It also covers dimensional metrology aspects and tools for micro and nanoscale manufacturing.

**Prerequisite:** Nil

**Course Outcomes:** After the completion of the course the student will be able to:

CO 1	Explain different techniques used in micro and nano manufacturing
CO 2	Describe conventional techniques used in micro manufacturing.
CO 3	Describe non-conventional micro-nano manufacturing approaches.
CO 4	Outline the working principle and applications of micro and nano finishing processes
CO 5	Explain the basics of micro and nano fabrication techniques.
CO 6	Apply and select metrology systems in micro and nano manufacturing.

**Mapping of course outcomes with program outcomes:**

	PO 1	PO 2	PO 3	PO 4	PO 5	PO 6	PO 7	PO 8	PO 9	PO 10	PO 11	PO 12
CO 1	3	-	-	-	-	-	1	-	2	1	1	-
CO 2	2	-	-	-	-	-	1	-	2	1	1	-
CO 3	2	-	-	2	-	-	1	-	2	1	1	-
CO 4	3	-	-	-	-	-	1	-	2	1	1	-
CO 5	2	-	-	-	-	-	1	-	2	1	1	-
CO 6	3	-	-	-	1	-	2	-	2	1	2	1

**Assessment Pattern**

Bloom's Category	Continuous Assessment Tests		End Semester Examination (marks)
	1 (marks)	2 (marks)	
Remember	20	20	40
Understand	20	20	40
Apply	10	10	20
Analyse	-	-	-
Evaluate	-	-	-
Create	-	-	-

**Mark distribution**

<b>Total Marks</b>	<b>CIE</b>	<b>ESE</b>	<b>ESE Duration</b>
150	50	100	3 hours

**Continuous Internal Evaluation Pattern**

Attendance	: 10 marks
Continuous Assessment Test (2 numbers)	: 25 marks
Assignment/Quiz/Course project	: 15 marks

**End Semester Examination Pattern:** There will be two parts; Part A and Part B. Part A contains 10 questions with 2 questions from each module, having 3 marks for each question. Students should answer all questions. Part B contains 2 questions from each module, of which student should answer any one. Each question can have maximum 2 sub-divisions and carry 14 marks.

**Course Level Assessment Questions****Course Outcome 1 (CO1):**

1. Explain different techniques used in micro and nano manufacturing.
2. Explain typical fabrication process for an Integrated Chip.
3. Describe 3 basic regimes of fabrication at microscale.

**Course Outcome 2 (CO2):**

1. Discuss application areas of micro-turned components.
2. Point out limitations and challenges of micro-extrusion process.
3. List out any 4 application areas of micro-milling process.

**Course Outcome 3 (CO3):**

1. How are micromolds designed?
2. Discuss the principle and process of micro-EDM.
3. Discuss the principle and process of micro-LBM.

**Course Outcome 4 (CO4):**

1. With the help of a suitable diagram, explain the principle of Magnetorheological finishing process.
2. Describe Magnetic Float Polishing.

3. Draw the schematic of Elastic Emission Machining and explain.

**Course Outcome 5 (CO5):**

1. Explain how an elastic stamp is manufactured using soft lithographic techniques.
2. Describe the structure and properties of CN tubes.
3. What are the different approaches to deposition of diamond in a CVD Diamond process. Explain.

**Course Outcome 6 (CO6):**

1. Explain Scanning white-light interferometry with the help of a suitable diagram.
2. Outline unique metrological challenges faced in micro-nano manufacturing?
3. Explain Scanning Electron Microscopy in detail.

**Model Question Paper**

**MET464 MICRO AND NANOMANUFACTURING**

Max. Marks: 100

Duration: 3 hours

**Part–A**

**Answer all questions. Each question carries 3 marks**

1. Define microgrinding.
2. Point out any 3 differences between macroturning and microturning.
3. Why are high speed air turbine spindles useful for micromachining?
4. What is hot embossing? Why is it particularly suited for manufacturing of optical components?
5. Draw the schematic of Chemical Mechanical Polishing process.
6. Illustrate the mechanism of material removal in Ion beam machining.
7. List out various materials used in semi-conductor industry.
8. Show by a schematic how an elastic stamp is manufactured using soft lithography?
9. Draw the schematic of typical scanning white light interferometry set up.
10. What are the merits and demerits of On-machine metrology?

**Part–B**

**Answer one full question from each module.**

**Module I**

11. Discuss in detail the design requirements of microturning machines. (14 marks)

**OR**

12. Discuss the outcomes of microgrinding of ceramic materials. (14 marks)

**Module II**

13. Discuss the Focused Ion Beam system. (14 marks)

**OR**

14. Discuss various methods available for manufacturing of micromolding tools. (14 marks)

**Module III**

15. Describe Magnetic float polishing with a neat diagram. (14 marks)

**OR**

16. Discuss the principles of MRAFF process with a suitable diagram. (14 marks)

**Module IV**

17. Explain how a Field effect transistor is fabricated by the process of soft lithography? (14 marks)

**OR**

18. Describe all properties of Carbon Nanotubes. (14 marks)

**Module V**

19. Explain the operation of scanning tunneling microscope. (14 marks)

**OR.**

20. What is Atomic force microscope? Explain its modes of operation. (14 marks)

2014

## Syllabus

### Module 1

Introduction to principles of micro and nano fabrication techniques- microfabrication of semiconductor devices-standard micro machining flow chart- basics of micro fabrication-manipulative techniques. Introduction to mechanical micro machining: Micro drilling-process, tools and applications, Micro turning- principle, process, tools and applications, Diamond micro turning- principle, process, tools and applications, Micro milling and Micro grinding-processes, tools and applications, Micro extrusion- principle, process and applications.

### Module 2

Introduction to Non-conventional micro-nano manufacturing: Abrasive Jet Micro-machining, WAJMM- principle, process and applications. Micro EDM, Micro WEDM, Micro EBM-principle, process and applications. Micro ECM, Micro LBM, Focused Ion Beams- process, principle and applications. Micro moulding processes: Injection moulding, Reaction injection moulding, hot embossing, injection compression moulding- micromolding tools-applications.

### Module 3

Introduction to micro-nano finishing processes: Magnetorheological Finishing (MRF) processes, Magneto-rheological Abrasive Flow Finishing (MRAFF) processes- Principle, equipment and applications- Force analysis for MRAFF process. Magnetic float polishing (MFP), Elastic Emission machining (EEM), Ion Beam Machining (IBM), Chemical Mechanical Polishing (CMP)- principle, equipment and applications

### Module 4

Introduction to Nano Fabrication: Nano fabrication using soft lithography- principle and applications. Introduction to Carbon nano materials- CN tubes- properties and applications. CN tube transistors-Diamonds- properties and applications- CVD Diamond technology- LIGA process. Laser micro welding- Electron Beam Micro welding.

### Module 5

Introduction to micro-nano inspection and metrology: Scanning electron microscopy, Scanning white light interferometry, Optical Microscopy, Scanning probe Microscopy, Scanning tunnelling microscopy, Confocal microscopy, Atomic force microscopy. Introduction to On-machine metrology.

**Text Books and References**

1. Mark J. Jackson, Micro and Nanomanufacturing, Springer, 2007.
2. N.P.Mahalik, Micromanufacturing and nanotechnology, Springer, 2006.
3. Mark J. Jackson, Microfabrication and Nanomanufacturing, Taylor and Francis-CRC press, 2006.
4. V.K. Jain, Micromanufacturing Processes, Taylor and Francis- CRC press, 2012.

**Course Contents and Lecture Schedule**

No.	Topic	No. of Lectures	COs
1.1	Introduction to micro-nano fabrication techniques- principles and evolution.	1	CO1
1.2	Overview of microfabrication of semiconductor devices- example- Integrated Chip.	1	CO1
1.3	Standard micro machining flow chart and basics of microfabrication-manipulative techniques.	2	CO1
1.4	Introduction to mechanical micro machining. Micro drilling-principle, process, description and applications.	1	CO2
1.5	Micro turning- principle, process, description and applications.	1	CO2
1.6	Diamond micro turning- principle, process, description and applications.	1	CO2
1.7	Micro milling and Micro grinding- principle, process, description and applications.	1	CO2 CO5
1.8	Micro grinding- principle, process, description and applications.	1	CO2
1.9	Micro extrusions- principle, process, description and applications.	1	CO2 CO5
2.1	Introduction to non-conventional micro-nano manufacturing- Abrasive jet micro machining, WAJMM- principle, process, description and applications.	2	CO3
2.2	Micro EDM, Micro WEDM, Micro EBM- process, principle, description and applications.	2	CO3
2.3	Micro ECM, Micro LBM- process, principle, description and applications.	1	CO3
2.4	Focused Ion Beams-process, principle and applications.	1	CO3
2.5	Micromolding process- Injection molding, reaction Injection molding- process, principle, description and applications.	1	CO3
2.6	Hot embossing, injection compression molding- description	1	CO3
2.7	Micromolding tools- applications.	1	CO3
3.1	Introduction to micro-nano finishing processes- magnetorheological finishing (MRF)- process, principle, description, application.	1	CO4
3.2	Magnetorheological abrasive flow finishing (MRAFF)- process, principle- Force analysis- description and applications.	1	CO4
3.3	Magnetic float polishing (MFP)- process, principle, description and applications.	1	CO4

3.4	Elastic emission machining (EEM), Ion beam machining (IBM)- process, principle, description and applications.	1	CO4
3.5	Chemical mechanical polishing (CMP)- process, principle, description and applications.	1	CO4
4.1	Introduction to Nanofabrication- Nanofabrication using soft lithography- principle and applications- examples- field effect transistor, elastic stamp.	1	CO5
4.2	Manipulative techniques- principle and description, applications.	1	CO5
4.3	Introduction to Carbon nano materials- CN tubes- properties and applications- CN tube transistors.	1	CO5
4.4	Diamonds- properties and applications- CVD diamond technology.	2	CO5
4.5	LIGA process.	1	CO5
4.6	Laser micro welding- Electron beam micro welding.	1	CO5
5.1	Introduction to micro-nano inspection and metrology- Scanning electron microscopy- principle and description.	1	CO6
5.2	Scanning white light interferometry- principle and description.	1	CO6
5.3	Optical microscopy- principle and description.	1	CO6
5.4	Scanning probe microscopy, Scanning tunnelling microscopy- principle, description and applications.	1	CO6
5.5	Confocal microscopy, Atomic force microscopy- principle and description.	1	CO6
5.6	Introduction to On-machine metrology.	1	CO6



CODE	COURSE NAME	CATEGORY	L	T	P	CREDIT
MET474	HEATING AND VENTILATION SYSTEMS	PEC	2	1	0	3

**Preamble:** The objectives of the course are:

- The course aims at exposing the students to the areas of heating ventilation and air conditioning systems and their applications.
- The students will be capable to select suitable system for an application.
- The students will be equipped with the basic technical knowledge regarding the subject, present trends and sustainable practices.

**Pre-requisite:** MET473 Refrigeration and Air conditioning.

**Course Outcomes:** After the completion of the course the student will be able to

CO 1	Explain the quality of air to be supplied for comfort and healthy condition.
CO 2	Compare different HVAC systems for an application.
CO 3	Design a HVAC system by selecting suitable components and environmentally safe refrigerant.
CO 4	Evaluate the cooling load and capacity requirement of ac machine
CO 5	Design the duct for HVAC and make the drawing.

**Mapping of course outcomes with program outcomes**

	PO 1	PO 2	PO 3	PO 4	PO 5	PO 6	PO 7	PO 8	PO 9	PO 10	PO 11	PO 12
CO 1	1											1
CO 2	1											1
CO 3	3		3				3					1
CO 4	3	3	3	3								1
CO 5	3	3		3								1

**Assessment Pattern**

Bloom's Category	Continuous Assessment			End Semester Examination
	Assignment (%)	Test 1 (%)	Test 2 (%)	
Remember	25	20	20	10
Understand	25	40	40	20
Apply	25	40	40	70
Analyse	25			
Evaluate				
Create				

**Mark distribution**

<b>Total Marks</b>	<b>CIE</b>	<b>ESE</b>	<b>ESE Duration</b>
150	50	100	3 hours

**Continuous Internal Evaluation Pattern:**

Attendance	: 10 marks
Continuous Assessment Test (2 numbers)	: 25 marks
Assignment/Quiz/Course project	: 15 marks

**End Semester Examination Pattern:**

There will be two parts; Part A and Part B. Part A contain 10 questions with 2 questions from each module, having 3 marks for each question. Students should answer all questions. Part B contains 2 questions from each module of which student should answer any one. Each question can have maximum 2 sub-divisions and carry 14 marks.

**Course Level Assessment Questions****Course Outcome 1 (CO1):**

1. What is the need of mixing return air to outdoor air?
2. Explain different types of air filters used and their specification?
3. Explain the % outdoor air requirements for different application?

**Course Outcome 2 (CO2)**

1. Explain VRF system and its advantages?
2. Explain terminal reheat system and its merits?
3. Explain all water system of refrigeration and its draw backs?

**Course Outcome 3 (CO3):**

1. Describe different types of refrigerants and their relative ODP and GWP?
2. Differentiate between scroll type compressor and reciprocating compressor?
3. What is cooling tower and explain its working principle?

**Course Outcome 4 (CO4):**

1. An Auditorium has seating capacity 800 people is to be maintained at 23°C DBT and 50% RH. The outdoor conditions are 40°C DBT and 27°C WBT. The various loads in the office are: Solar heat gain 10KW, sensible heat gain per occupant 80W, Latent heat per occupant 70W, Lighting load 5KW, Sensible heating load from other

sources 12KW, Infiltration load  $0.3\text{m}^3/\text{sec}$ . Outdoor air and return air is mixed in the ratio of 1: 6 ,before cooling coil (processing unit) and then supplied to room. The supply temperature cannot be lower than  $12^{\circ}\text{C}$  .find capacity of the plant required, mass flow rate of air.

2. What are ESR, ISEER, GSHF and RSHF? Explain.
3. Explain the method of basement ventilation Systems?

**Course Outcome 5 (CO5):**

1. What are the general aspects to be considered while designing a duct system?
2. Explain equal friction method of determination of duct size?
3. Write any five notations, legends, symbols used in HVAC drawing.

**Model Question Paper**

**APJ ABDUL KALAM TECHNOLOGICAL UNIVERSITY  
HEATING AND VENTILATION SYSTEMS–MET474**

**MAXIMUM: 100 MARKS**

**DURATION: 3 HOURS**

**PART A**

**Answer all questions. Each question carries 3 marks**

1. What is HEPA filter? Where it is used?
2. What is the need of mixing return air to outdoor air??
3. What is the need of air water system of air conditioning system?
4. What is the difference between CAV and VAV system of air conditioning?
5. What are ODP and GWP of a refrigerant?
6. What are the disadvantages of hydrocarbon reorientants?
7. What is IPLV of an ac system?
8. Explain the method of basement ventilation Systems?
9. Write any five notations, legends, symbols used in HVAC drawing.
10. What is throw of air?

(10 X 3 = 30 Marks)

**PART B****Answer one full question from each module****MODULE 1**

11. a. Explain the % outdoor air requirements for different application? 7 marks
- b. Explain comfort chart? How to locate comfort region for all-round air conditioning? 7 marks
12. a. Explain effective temperature? What are the factors effecting effective temperature? 7 marks
- b. Explain any two methods of dehumidification and represent it as line diagram in psychrometric chart. 7 marks

**MODULE II**

13. a. Explain Dual duct system with the help of neat sketch? 7 marks
- b. Explain VRF system and its advantages over the conventional system? 7 marks
14. a. Explain all air system of air conditioning with the help of neat sketch? 7 marks
- b. Explain the air conditioning system suitable for an auditorium, restaurant and bed room with proper justifications? 7 marks

**MODULE III**

15. a. Explain CFC, HCFC, and HFC, HC refrigerants with suitable examples and relative merits and demerits. 7 marks
- b. What are the methods to check leak and ensure capacity during commissioning of an ac system? 7 marks
16. a. Explain scroll type compressor with the help of a neat sketch? 7 marks
- b. What is the use of a cooling tower? Explain the working with the help of a neat sketch. 7 marks

**MODULE IV**

17. a. An Auditorium has seating capacity 800 people is to be maintained at 23°C DBT and 50% RH. The outdoor conditions are 40°C DBT and 27°C WBT. The various loads in the office are: Solar heat gain 10KW, sensible heat gain per occupant 80W, Latent heat per occupant 70W, Lighting load 5KW, Sensible heating load from other sources 12KW, Infiltration load 0.3m<sup>3</sup>/sec. Outdoor air and return air is mixed in the ratio of 1: 6 ,before cooling coil (processing unit) and then supplied to room. The supply temperature cannot be lower than 12°C .find capacity of the plant required, mass flow rate of air. 10 marks
- b. Explain different thermal insulation materials used in ac system. 4 marks

18.a. Explain various heating loads in an auditorium? How infiltration load accounted while calculating RSHF 7 marks

b. explain bypass factor. Represent the bypass factor in a psychrometric chart for a cooling coil. 7 marks

### MODULE V

19 a. A packaged air conditioner serves four rooms in an apartment. The schematic layout of the duct system together with the volume flow rate to each room is shown in Figure. The duct shall be of standard round sections. The air velocity in the first section is not to exceed 25 m/s. There is a pressure drop of 5 Pa at each of the outlet grilles at F,H,M and K. Assume the resistance due to the fittings as below. Assume pressure drop at Elbow 2 pa, pressure drop at Tee joint= 1Pa. Determine the size of the duct system using the equal-friction method. Estimate the static pressure drop in each line

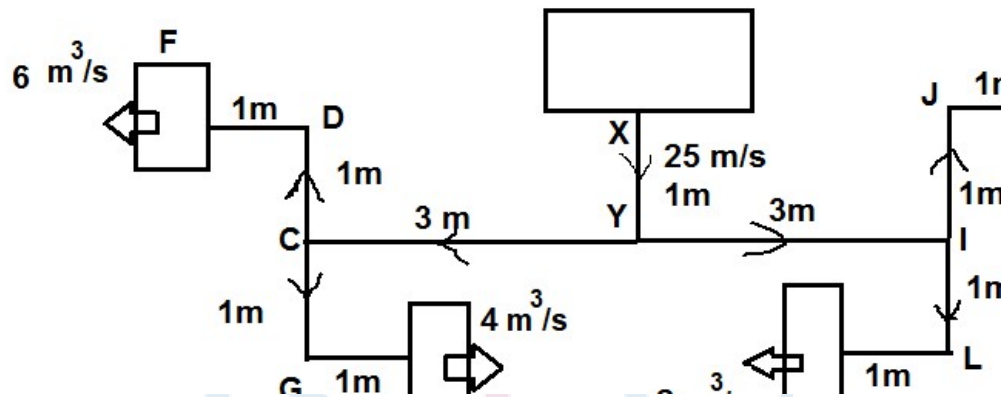

12 marks

b. What is spread of air? 2 marks

20 a. Explain Principles of air distribution. 7 marks

b. draw a simple drawing of an air conditioning system for a conference hall of seating capacity 50 people? 7 marks

## Syllabus

### Module 1- Introduction to HVAC

Importance of HVAC systems. Standard requirements of ventilation air for different applications. Air changes per hour -Conditions for comfort –comfort chart, effective temperature. Factors effecting effective temperature, Methods of dehumidification, humidification, and temperature control. Mixing of air stream. Type of air filters and their specification, HEPA filters.

### Module 2 Air conditioning systems.

Unitary system, window , split system, central station system, all air system, all water system, air-water system, VAV system , CAV systems Terminal reheat system, Dual duct system, Multi- zone system, Fan Coil units , relative merits and demerits – selection of particular system for an application. Cassette ac system. VRF system and inverter AC - relative merits.

### Module 3 Components of HVAC

Type of Compressors used- rotary, reciprocating, scroll type- cooling and heating coil. Environment friendly refrigerants.CFC, HCFC, HFC, HC refrigerants.Ozone depletion potential(ODP), global warming potential(GWP), use of boilers in HVAC, ducts, electrical systems for HVAC, air distribution system -types of outlets- diffusers- condensers, cooling tower, air handling unit, pumps, air dampers. Hot water generator and chilled condenser water piping. Testing and maintenance on ducts and pipes. Refrigerant leak detection methods.

### Module 4 Systems and Applications

Capacity determination of an ac machine. COP, EER, IEER, IPLV, star rating, specification of capacity TONs, HP, Cooling load calculation, sensible heat loads, latent heat loads, SHF, RSHF, GSHP, infiltration, bypass factor, Numerical examples. Methods to check the capacity during commissioning of new ac machine. Passive techniques to reduce cooling loads or heating loads in building. Insulation materials.

Basement ventilation Systems, Basement ventilation. Car park ventilation, Toilet, pantry ventilation.

### Module 5 Duct design

General consideration of duct design. Duct size determination. Equal friction method, balanced capacity method, Static regains method assumed velocity method. Location with due consideration for reduction of heat gain. Layout of supply and return air ducts. General considerations in air duct design layout. Throw of air, Spread of air, Entrainment ratio, Principles of air distribution, Sound and Vibration control techniques.

HVAC drawings, understanding notations, legends, symbols used in HVAC drawing.

**Text Books**

1. Refrigeration and Air Conditioning, Arora C.P, Tata McGraw hill.
2. A Course in Refrigeration and air conditioning Arora S. C. and S. Domkundwar, Dhanpat Rai and Company. 2002
3. A text book of Refrigeration and air conditioning – R.K .Regiput, Katson books.
4. Refrigeration and air conditioning - Ahamadul Ameen Eastern economy addition.
5. Heating, Ventilating, and Air Conditioning: Analysis and Design, Faye C. Mcquiston, Jerald D. Parker, Jeffrey D. Spitler, John Wiley and sons. New York

**Data books**

1. Refrigeration tables and charts including air conditioning data, C P Kothandaraman, New Age International.
2. Refrigeration and air conditioning data book, Domkunduwar and Domkundwar, Dhanpat Rai & co.

**Reference books**

1. ASHRAE Handbook 201(Volume 1, 2, 3)
2. Principles of heating ventilation and air conditioning in building, john Dixon, Delmar learning
3. Analysis and design of heating ventilation and air conditioning system, Herbert W Stanford and Adam F spach, CRC press -Taylor and Francis.

**Course Contents and Lecture Schedule**

MODULE	TOPICS	HOURS ALLOTTED
1	Importance of HVAC systems. Standard requirements of ventilation air for different applications. Air changes per hour	2-1-0
	Conditions for comfort –comfort chart, effective temperature. Methods of dehumidification, humidification, and temperature control. Mixing of air stream.	2-0-0
	Type of air filters and their specification, HEPA filters.	1-0-0
2	Unitary system, window , split system, central station system, all air system, all water system, air-water system, VAV system , CAV systems Terminal reheat system, Dual duct system, Multi-zone system, Fan Coil units , relative merits and demerits – selection of particular system for an application. Cassette ac system. VRF system and inverter AC - relative merits.	3-1-0
	Type of Compressors used- rotary, reciprocating, scroll type,	

3	cooling and heating coil. Environment friendly refrigerants.CFC, HCFC, HFC, HC refrigerants.Ozone depletion potential(ODP), global warming potential(GWP), use of boilers in HVAC, ducts, electrical systems for HVAC, air distribution system -types of outlets- diffusers- condensers, cooling tower, air handling unit, pumps, air dampers. Hot water generator and chilled condenser water piping. Testing and maintenance on ducts and pipes. Refrigerant leak detection methods.	4-2-0
4	Capacity determination of an ac machine. COP, EER, IEER, IPLV, star rating, specification of capacity TONs, HP, Cooling load calculation, sensible heat loads, latent heat loads, SHF, RSHF, GSHF, infiltration, bypass factor, Numerical examples	4-2-0
4	Methods to check the capacity during commissioning of new ac machine. Passive techniques to reduce cooling loads or heating loads in building. Insulation materials.	2-1-0
	Basement ventilation Systems, Basement ventilation. Car park ventilation, Toilet, pantry ventilation.	2-0-0
5	General consideration of duct design. Duct size determination. Equal friction method, balanced capacity method, Static regains method assumed velocity method. Location with due consideration for reduction of heat gain. Layout of supply and return air ducts. General considerations in air duct design layout. Throw of air; Spread of air, Entrainment ratio, Principles of air distribution, Sound and Vibration control techniques.	3-1-0
	HVAC drawings, understanding notations, legends, symbols used in HVAC drawing. Simple drawing of a ac system for an auditorium and conference room	3-1-0

Estd.



2014

APJ ABDUL KALAM  
TECHNOLOGICAL  
UNIVERSITY

---

**SEMESTER VIII**

---

**PROGRAM ELECTIVE IV**

---





**Assessment Pattern**

Bloom's Category	Continuous Assessment Tests		End Semester Examination
	1	2	
Remember	25	25	25
Understand	15	15	15
Apply	30	30	30
Analyse	10	10	10
Evaluate	10	10	10
Create	10	10	10

**Mark distribution**

Total Marks	CIE	ESE	ESE Duration
150	50	100	3 hours

**Continuous Internal Evaluation Pattern:**

Attendance	: 10 marks
Continuous Assessment Test (2 numbers)	: 25 marks
Assignment/Quiz/Course project	: 15 marks

**End Semester Examination Pattern:**

There will be two parts; Part A and Part B. Part A contain 10 questions with 2 questions from each module and having 3 marks for each question. Students should answer all questions. Part B contains 2 questions from each module of which student should answer any one. Each question carries 14 marks and can have a maximum of 2 subdivisions.

**Course Level Assessment Questions****Course Outcome 1 (CO1):**

- 1 Explain about history of evolution of composites
- 2 Explain about the function of reinforcement and matrix in composite
- 3 Classify the composite according to type of matrix and reinforcement
- 4 What are the advantages and disadvantages of composites
- 5 Discuss about smart composites
- 6 Explain about types of bonding at interface
- 7 Explain about wettability of composites

**Course Outcome 2 (CO2)**

- 1 Compare between natural fibers and synthetic fibers
- 2 Explain the procedure of boron fiber fabrication
- 3 Explain Ex-Pan carbon fiber and Ex-Pitch carbon fiber fabrication
- 4 With neat sketched explain Ex-cellulose carbon fiber.
- 5 Discuss about aramid fiber fabrication
- 6 Explain whiskers with examples.

**Course Outcome 3(CO3):**

- 1 Discuss about thermoset, thermoplastic and elastomeric polymeric materials
- 2 Explain different hand lay methods
- 3 Explain different moulding methods for PMC

**Course Outcome 4 (CO4):**

- 1 How the metal matrix composites are classified
- 2 Explain the role of intermetallics in MMC
- 3 What are the properties, characteristics and applications of MMC
- 4 Explain different production techniques of MMC

**Course Outcome 5 (CO5):**

- 1 How CMC are classified and their potential role as matrices material.
- 2 What are the properties, characteristics and applications of CMC.
- 3 Explain conventional techniques for the production of CMC.
- 4 Explain maximum stress and strain criterion related to micromechanics of composites
- 5 Derive expression for Tsai-Hill and Tsai-Wu failure criterion.

**Model Question Paper**

**APJ ABDUL KALAM TECHNOLOGICAL UNIVERSITY**

**EIGHTH SEMESTER B.TECH DEGREE EXAMINATION**

**Course Code : MET416**

**Course Name : COMPOSITE MATERIALS**

Max. Marks : 100

Duration : 3 Hours

**PART – A**

**(ANSWER ALL QUESTIONS, EACH QUESTION CARRIES 3 MARKS)**

- 1) What are the conditions to be satisfied for a material to be called as a composite material.
- 2) Define wettability in fiber-matrix bonding and its importance in composite properties.
- 3) What are the important application of aramid fibers.
- 4) Write a short note on Boron fibers.
- 5) Compare thermosetting and thermoplastic matrix material.
- 6) List the function of components in pultrusion technique used in PMCs.

- 7) What are the modifications required in casting process for improving the properties of metal matrix composites.
- 8) Name the metals and their properties used in metal matrix composites.
- 9) With the aid of neat sketch explain lanxide process.
- 10) What are the different failure modes of fiber composites?

**PART – B**

**(ANSWER ONE FULL QUESTION FROM EACH MODULE)**

**MODULE – 1**

11. (a) Classify the composite materials based on the geometry of the reinforcement and matrix. ( 7 Marks)
- (b) Explain the different types of bonding interfaces in composites with sketches. ( 7 Marks )

**OR**

12. (a) What are the advantages of composite materials over the conventional engineering materials? (6 marks)
- (b) Explain about 1) Fiber pull out 2) Delamination 3) Fiber bridging 4) Debonding ( 8 Marks )

**MODULE – 2**

13. (a) How the carbon fibers are produced from PAN? (7 marks)
- (b) Describe the filament winding process in polymer matrix composites. (7 marks)

**OR**

14. (a) Explain different types of whiskers with examples. (7 marks)
- (b) Write a short note on wet jet spinning process for producing aramid fibers (7 marks)

**MODULE – 3**

15. (a) With neat sketch, explain the hand lay-up process? (7 marks)
- (b) With neat sketches explain manufacturing of laminated composite using prepreg (7 marks)

**OR**

16. (a) Explain the significance of various polymer materials used for PMC production? (7 marks)
- (b) With neat sketch, explain the bag moulding process? (7 marks)

**MODULE – 4**

17. (a) With neat sketches explain about In situ process by unidirectional solidification (7 marks)

- (b) With the aid of neat sketch explain Squeeze casting method for MMC? (7 marks)

**OR**

18. (a) Explain application of precipitation-hardenable alloy materials used in the manufacture of metal matrix composites (7 marks)

- (b) Write a short note about diffusion bonding. (7 marks)

**MODULE – 5**

19. (a) With neat sketches explain liquid infiltration process in ceramic matrix composites (7 marks)

- (b) State and explain the maximum- stress theory for predicting the composite failure (7 marks)

**OR**

20. (a) Explain the in-situ chemical reaction techniques for CMC production? (7 marks)

- (b) Describe the Tsai-Hill failure criteria for composites. (7 marks)



**SYLLABUS****Module 1**

Composite : Introduction, definition, characteristics, functions, classification of composites based on structure and matrix , smart composites, advantages and limitations, history, industrial scene and applications, Interfaces: wettability and bonding interface in composites. types of bonding at interface.

**Module 2**

Fibers : Introduction, types of fibers, natural fibers, glass fiber fabrication, structure, properties and applications, boron fiber fabrication, structure, properties and applications, carbon fiber, Ex-Pan carbon fiber, Ex cellulose carbon fiber, Ex-Pitch carbon, carbon fiber structure, properties and applications, aramid fiber fabrication, structure, properties and applications, whiskers: characteristics, properties and applications.

**Module 3**

Polymer matrix composites (PMC) : thermoset, thermoplastic and elastomeric polymers, properties, characteristics and applications as matrix materials, processing of polymer matrix composites: hand methods, Lay up method, spray up method, moulding methods, pressure bagging and bag moulding methods, Autoclave-based processing with prepregs, pultrusion and filament winding process.

**Module 4**

Metal matrix composites (MMC) : classification of metals, intermetallics, alloys and their potential role as matrices in composites, properties, characteristics and applications of metals as matrix materials, production techniques: powder metallurgy, diffusion bonding, melt stirring, squeeze casting, liquid infiltration under pressure, insitu process.

**Module 5**

Ceramic matrix composites (CMC) : classification of ceramics and their potential role as matrices, properties, characteristics and applications of ceramics as matrix materials, conventional techniques : cold pressing and sintering, hot pressing, reaction bonding, liquid infiltration, pultrusion. lanxide process, insitu chemical technique, sol-gel technique, Micromechanics of composites: maximum stress and strain criterion (derivations only). Tsai-Hill and Tsai-Wu failure criterion (derivations only). mechanics of load transfer from matrix to fiber (description)

**Text Books**

1. K. K. Chawla, Composite Materials : Science and Engineering, Springer, 3e, 2013.
2. P.K.Mallicak, Fiber-reinforced composites , Monal Deklar Inc., New York, 1988.
3. Reddy J N (Ed.), Mechanics of Composite Materials; Selected Works of Nicholas J. Pagano, Springer, 1994
4. Robert M. Jones, Mechanics of Composite Materials, CRC Press, 1998

**Reference Books**

1. F.L.Matthews & R.D.Rawlings, Composite Materials, Engineering and Sciences, Chapman & hall, London, 1994
2. Hand Book of Composites, George Lubin. Van Nostrand, Reinhold Co. 1982
3. Micael hyer, Stress Analysis of Fiber - Reinforced Composite Materials , Tata McGraw Hill, 1998.

**Course Contents and Lecture Schedule:**

No	Topic	No of lectures + Tutorial
<b>1</b>	<b>Module 1: Introduction to composites</b>	<b>7 hours</b>
1.1	Composite : Introduction, definition, characteristics, functions	1L
1.2	Classification of composites based on structure and matrix: History, industrial scene and applications	1L
1.3	Smart composites, advantages and limitations	1L+1L
1.4	Interfaces: wettability and bonding interface in composites	1L
1.5	Types of bonding at interface.	1L + 1T
<b>2</b>	<b>Module 2: Types of fibers/ whiskers used in composites</b>	<b>7 hours</b>
2.1	Fibres : Introduction, types of fibers, natural fibers	1L
2.2	Fiberization, stabilization, carbonization, graphitization, glass fiber Fabrication, structure, properties and applications	1L
2.3	Boron fiber fabrication, structure, properties and applications	1L
2.4	Carbon fiber, Ex-Pan carbon fiber, Ex-Pitch carbon, Ex cellulose carbon fiber	1L + 1T
2.5	Aramid fiber fabrication, structure, properties and applications	1L
2.6	Whiskers: characteristics, properties and applications.	1L
<b>3</b>	<b>Module 3: Polymer matrix composites</b>	<b>6 hours</b>
3.1	Polymer matrix composites (PMC) : thermoset, thermoplastic and Elastomeric polymers	1L
3.2	Properties, characteristics and applications as matrix materials	1L
3.3	Processing of polymer matrix composites: hand methods, Lay up method, spray up method	1L
3.4	Moulding methods, pressure bagging and bag moulding methods, Autoclave-based processing with prepregs	1L + 1T
3.5	Pultrusion and filament winding process.	1L

<b>4</b>	<b>Module 4: Metal matrix composites</b>	<b>7 hours</b>
4.1	Classification of metals, intermetallics, alloys and their potential role as matrices in composites	2L
4.2	Properties, characteristics and applications of metals as matrix materials	1L
4.3	Production techniques: powder metallurgy, diffusion bonding, melt stirring	1L + 1T
4.4	Squeeze casting, liquid infiltration under pressure, insitu process.	1L + 1T
<b>5</b>	<b>Module 5: Ceramic matrix composites &amp; Micromechanics of composites</b>	<b>8 hours</b>
5.1	Classification of ceramics and their potential role as matrices	1L
5.2	Properties, characteristics and applications of ceramics as matrix materials	1L
5.3	Conventional techniques : cold pressing and sintering, hot pressing, Reaction bonding, liquid infiltration, pultrusion.	1L
5.4	Lanxide process, insitu chemical technique, sol-gel technique	1L
5.5	Micromechanics of composites: maximum stress and strain criterion (derivations only)	1L + 1T
5.6	Tsai-Hill and Tsai-Wu failure criterion (derivations only)	1L
5.7	Mechanics of load transfer from matrix to fiber (description only)	1L



CODE	COURSE NAME	CATEGORY	L	T	P	CREDIT
MET426	ARTIFICIAL INTELLIGENCE AND MACHINE LEARNING	PEC	2	1	0	3

**Preamble:** This course is specifically designed for Mechanical Engineers to get acquainted with essential mathematical concepts, brush up on their statistics and the fundamentals of ML and AI

**Prerequisite:** NIL

**Course Outcomes:** After the completion of the course the student will be able to

CO Nos	Course Outcomes	Level of learning domain
CO 1	Illustrate the basic mathematics of artificial intelligence and Machine learning	2
CO 2	Explain the concepts of artificial intelligence	2
CO 3	Explain machine learning techniques and computing environment that are suitable for the applications under consideration	2
CO 4	Develop scaling up machine learning techniques and associated computing techniques and technologies for various applications	3
CO 5	Explain data analytics and Machine learning Applications	2

**Mapping of course outcomes with program outcomes**

	PO 1	PO 2	PO 3	PO 4	PO 5	PO 6	PO 7	PO 8	PO 9	PO 10	PO 11	PO 12
CO 1	3	2			2							1
CO 2	3	2			2							1
CO 3	3	2			2							1
CO 4	3	2			2							1
CO 5	3	2			2							1

**Assessment Pattern**

Bloom's Category	Continuous Assessment Tests		End Semester Examination
	1	2	
Remember			
Understand	40	40	70
Apply	10	10	30
Analyse			
Evaluate			
Create			

**Mark distribution**

<b>Total Marks</b>	<b>CIE</b>	<b>ESE</b>	<b>ESE Duration</b>
150	50	100	3 hours

**Continuous Internal Evaluation Pattern:**

Attendance	: 10 marks
Continuous Assessment Test (2 numbers)	: 25 marks
Assignment/Quiz/Course project	: 15 marks

**End Semester Examination Pattern:** There will be two parts; Part A and Part B. Part A contain 10 questions with 2 questions from each module, having 3 marks for each question. Students should answer all questions. Part B contains 2 questions from each module of which student should answer any one. Each question can have maximum 2 sub-divisions and carry 14 marks.

**Course Level Assessment Questions****Course Outcome 1 (CO1):**

1. Define Maximum error estimate
2. Define simple correlation and write formula for simple correlation coefficient
3. Write the expression for the control line and three sigma for mean Chart

**Course Outcome 2 (CO2)**

1. What is Artificial Intelligence?
2. Application of Artificial Intelligence
3. Explain about neural networks?

**Course Outcome 3(CO3):**

1. Machine learning concepts with examples.
2. Discuss supervised and unsupervised learning?
3. Write a program using python

**Course Outcome 4 (CO4):**

1. Explain KNN?
2. What is web scraping?
3. Discuss about Natural Language processing

**Course Outcome 5 (CO5):**

1. What are the benefits of Data science for Mechanical Engineers?
2. Explain about Numpy and pandas
3. Write about the potential applications of Machine learning in manufacturing sector?

**Model Question Paper****MET 426 - ARTIFICIAL INTELLIGENCE AND MACHINE LEARNING****Max. Marks : 100****Duration : 3 Hours****Part – A****Answer all questions, each question carries 3 marks**

1. Define Maximum error estimate
2. Write the normal equations for the least square curve of the form  $y = ab^x$
3. What are the Problem Characteristics of Artificial Intelligence?
4. What is a Rule based programming?
5. Define machine learning.
6. Discuss any four examples of machine learning applications
7. Write down the major differences between K-means clustering and hierarchical clustering
8. Explain the different string formats available in Python with examples
9. What is data science and its benefits?
10. What are the goals of data science?

**PART -B****Answer one full question from each module.****MODULE – 1**

11. Find moment generating function for binomial distribution and hence find its mean and variance (14 marks)
- OR
12. Samples of size 2 are taken from the population 4,8,12,16,20,24 with replacement. Find
    - a) The mean of the population
    - b) The standard deviation of the population
    - c) Mean of the sampling distribution of means
    - d) The standard deviation of the sampling distribution of mean. (14 marks)

**MODULE – 2**

13. Give details of the year-wise development of AI. How AI is being used in the area of Mechanical engineering research (14 marks)
- OR
14. (a) Differentiate between the various learning methods: neural networks, reinforcement learning and genetic algorithm (8 marks)
  - (b) What are the various heuristic techniques .Explain how they are different from the solution guaranteed techniques (6 marks)

**MODULE – 3**

15. Distinguish between supervised learning and Reinforcement learning. Illustrate with an example (14 marks)
- OR
16. (a) Write a program to print the sum of the following series  $1 + 1/2 + 1/3 + \dots + 1/n$  (8 marks)
  - b) Explain the need for continue and break statements. Write a program to check whether a number is prime or not. Prompt the user for input. (6 marks)

**MODULE – 4**

17. Explain about web scraping and discuss about the possibility of usage (14 marks)  
OR
18. (a) Explain about Semantic Analysis? (4 marks)  
b) What do you understand by Natural Language Processing? List any two real-life applications of Natural Language Processing. (10 marks)

**MODULE – 5**

19. (a) Illustrate with an example different stages of data science project. (8 marks)  
b) How the AI technology used in automobile industry (6 marks)
- OR
20. Explain the importance of Machine learning concepts in manufacturing sector (14 marks)

**Syllabus****Module 1**

Fundamentals of probability and statistics – Probability theory- sample and population – statistical interference – random process – logical relations – conditional probability – density function – distributions – regressions – parametric estimation – non parametric – statistical test.

**Module 2**

Introduction to artificial intelligence - Typical Applications, Keras API, Artificial Neural Networks (ANNs): Concept, Activation Functions, Feed Forward Neural Networks and Back Propagation-Working of CNN, Convolutional Layer, Pooling, Flatten, Image recognition techniques and feature Extraction fundamentals

**Module 3**

Machine learning: Introduction, Types of Machine Learning: Supervised, Unsupervised and Reinforcement learning, Applications, Classification vs Prediction Problems, Linear Regression Algorithm, Python Basics – string, number, list, tuple, Dictionary, functions, conditional statement, Loop statements, simple programming exercises using python

**Module 4**

Introduction to KNN (K Nearest Neighbor), Working of KNN, Decide the value of K, Confusion Matrix, Accuracy Score, Web Scraping Basics- Need of Web Scraping, Natural Language Processing: Introduction, Stages in natural language Processing, Application of NLP in Real world applications

**Module 5**

Introduction to Data Science, Flow of Data Science, Numpy, Pandas, Matplotlib. Machine Learning Applications across Industries.

**Text Books**

1. T.K.V. Iyengar “Probability & Statistics”, S.Chand (G/L) & Company Ltd, 2008
2. Schalkoff, R.J., “Artificial Intelligence: An Engineering Approach”, McGraw-Hill, 1990
3. Stuart Russell and Peter Norvig, “Artificial Intelligence: A modern approach”. Prentice Hall, New Jersey, 1995
4. Ethem Alpaydin, Introduction to Machine Learning, 2nd edition, MIT Press 2010
5. Tom Mitchell, Machine Learning, McGraw-Hill, 1997

**Reference Books**

1. Nilson, N. J., “Principles of Artificial Intelligence”, Springer Verlag, Berlin, 1980
2. Eugene Charniak and Drew McDermot, “Introduction to Artificial Intelligence”, Addison Wesley Longman Inc., 1998
3. Trevor Hastie, Robert Tibshirani, Jerome Friedman, The Elements Of Statistical Learning, Second edition Springer 2007
4. Shai Shalev-Shwartz and Shai Ben-David., Understanding Machine Learning , Cambridge University Press. 2017

**Course Contents and Lecture Schedule**

No	Topic	No. of Lectures
<b>MODULE 1</b>		
1.1	Probability theory- sample and population – statistical interference	2
1.2	random process – logical relations	2
1.3	conditional probability – density function – distributions	2
1.4	Parametric estimation – non parametric – statistical test.	1
<b>MODULE 2</b>		
2.1	Introduction to artificial intelligence - Typical Applications	1
2.2	Keras, API	1
2.3	Artificial Neural Networks (ANNs): Concept, Activation Functions	2
2.4	Feed Forward Neural Networks and Back Propagation-	1
2.5	Working of CNN, Convolutional Layer, Pooling, Flatten, Image recognition techniques	2
<b>MODULE 3</b>		
3.1	Machine learning: Introduction	1
3.2	Supervised, Unsupervised and Reinforcement learning,	2
3.3	Classification vs Prediction Problems, Linear Regression Algorithm	2
3.4	Python Basics, simple programming exercises using python	2
<b>MODULE 4</b>		
4.1	Introduction to KNN (K Nearest Neighbor), Working of KNN	2

4.2	Confusion Matrix, Accuracy Score	2
4.3	Web Scraping Basics- Need of Web Scraping	2
4.4	Natural Language Processing: Introduction, Stages in natural language Processing	1
<b>MODULE 5</b>		
5.1	Introduction to Data Science	2
5.2	Flow of Data Science	2
5.3	Numpy, Pandas, Matplotlib	2
5.4	Machine Learning Applications across Mechanical Industries	2



CODE	COURSE NAME	CATEGORY	L	T	P	CREDIT
MET436	ACOUSTICS AND NOISE CONTROL	PEC	2	1	0	3

**Preamble:** Course objectives:

- To understand the principles of acoustics.
- To give awareness about different acoustic measurement instruments and analysis equipment.
- To introduce the importance of noise control
- To give awareness about regulations and standards related to noise exposure.

**Prerequisite:** Nil

**Course Outcomes:** After the completion of the course the student will be able to

CO No.	Course Outcomes	Level of learning domain
CO 1	Explain various acoustic terminologies and understand the physics behind acoustic wave propagation	2
CO 2	Evaluate reflection and transmission coefficients in sound transmission through different media and understand the concept of standing waves	5
CO 3	Explain the mechanism of hearing, concept of noise, various noise criteria and standards	2
CO 4	Explain different noise measures and various noise measurement devices	2
CO 5	Apply noise control measures to different machines and devices	3

**Mapping of course outcomes with program outcomes**

	PO 1	PO 2	PO 3	PO 4	PO 5	PO 6	PO 7	PO 8	PO 9	PO 10	PO 11	PO 12
CO 1	3	3	2									
CO 2	3	3	3			3						
CO 3	3	3	2			3	3					
CO 4	3	3	2			3						
CO 5	3	3	3			3	3					

**Assessment Pattern**

Bloom's Category	Continuous Assessment Tests		End Semester Examination
	1	2	
Remember			
Understand	20	20	30
Apply	20	20	50
Analyse			
Evaluate	10	10	20
Create			

**Mark distribution**

Total Marks	CIE	ESE	ESE Duration
150	50	100	3 hours

**Continuous Internal Evaluation Pattern:**

Attendance	: 10 marks
Continuous Assessment Test (2 numbers)	: 25 marks
Assignment/Quiz/Course project	: 15 marks

**End Semester Examination Pattern:** There will be two parts; Part A and Part B. Part A contain 10 questions with 2 questions from each module, having 3 marks for each question. Students should answer all questions. Part B contains 2 questions from each module of which student should answer any one. Each question can have maximum 2 sub-divisions and carry 14 marks.

**Course Level Assessment Questions****Course Outcome 1 (CO1):**

1. Derive acoustic wave equation. Deduce the equation for plane acoustic wave
2. Describe about Acoustic impedance, Energy density and Sound intensity.
3. a) Discuss about different 'levels' of sound measurement  
b) A harmonic plane wave is propagating with frequency 35 Hz in air at room temperature. The acoustic pressure at a point 1.5 m from the sound source at a time 2 s from the instant of observation is 0.2 Pa. Find the acoustic pressure at the same point at 4 s.

**Course Outcome 2 (CO2)**

1. Describe about spherical waves, beam width and directivity index.
2. Sound wave is propagating from a fluid medium of density  $\rho_1$  to a fluid medium of density  $\rho_2$  at an angle of incidence  $\theta_i$ . Speed of sound in first medium is  $c_1$  and that in second medium is  $c_2$ . Obtain the pressure reflection and pressure transmission coefficient.
3. There was some concern that over-water flights of the supersonic transport would harm marine life. A plane sound wave from the aircraft in air ( $\rho = 1.1\text{kg/m}^3$ ,  $c = 347\text{ m/s}$ ) has a sound pressure of 140 dB. The sound wave strikes the surface of the sea water ( $\rho = 1022\text{kg/m}^3$ ,  $c = 1500\text{ m/s}$ ) normally. Determine the intensity of the transmitted wave in sea water and the magnitude of the rms acoustic pressure of the transmitted wave

**Course Outcome 3(CO3):**

1. With the help of a neat sketch explain the hearing mechanism in human beings
2. a) Describe about speech interference level and perceived noise level  
b) Explain about threshold of hearing
3. Describe about any two noise standards

**Course Outcome 4 (CO4):**

1. Brief about sound level meter and dosimeter
2. a) Explain about the working of noise analyser  
b) What are microphones?
3. How sound is measured in a reverberation chamber and in an anechoic chamber

**Course Outcome 5 (CO5):**

1. Explain about absorption coefficient. What are acoustic absorbers? Brief about any one type of acoustic absorber
2. a) Suggest some measures to control the noise produced by sound source.  
b) How noise can be controlled in reciprocating machines?
3. What are possible causes for noise in a rotating machinery? Explain some measures to control such noise

**Model Question Paper**

**APJ ABDUL KALAM TECHNOLOGICAL UNIVERSITY  
EIGHTH SEMESTER B. TECH DEGREE EXAMINATION**

**Course Code: MET436**

**Course Name: ACOUSTICS AND NOISE CONTROL**

**Max. Marks: 100**

**Duration: 3 Hours**

**PART – A**

**(Answer all questions, each question carries 3 marks)**

1. What are plane acoustic waves?
2. Explain about sound pressure level?
3. A fan alone produces a sound intensity level of 80 dB. A pump and a fan together produce an intensity level of 86.2 dB. Determine the intensity level of the sound produced by the pump.
4. What are Helmholtz resonators?
5. Describe about plenum chambers.
6. Discuss about phon.
7. How standing waves are generated?
8. Brief about spherical waves
9. Describe about frequency weighting
10. Discuss about Number noise index

**PART – B**

**(ANSWER ONE FULL QUESTION FROM EACH MODULE)**

**Module – 1**

11. a) Derive acoustic wave equation. Deduce the equation for plane acoustic wave (9 Marks)
- b) A harmonic plane wave is propagating with frequency 35 Hz in air at room temperature. The acoustic pressure at a point 1.5 m from the sound source at a time 2 s from the instant of observation is 0.2 Pa. Find the acoustic pressure at the same point at 4 s. (5 Marks)
12. a) Elaborate about particle velocity and phase velocity (4 Marks)
- b) Obtain the D'Alembert's solution of plane acoustic wave equation
- c) Calculate the speed of sound in air having a density of  $1.225 \text{ kg/m}^3$  and pressure of 101 kPa. Take the adiabatic constant as 1.44. (3 Marks)

**Module 2**

13. a) A plane wave is incident at the boundary between air and helium at 20 degree C. Given that at 20degree C air density is  $1.2041 \text{ kg/m}^3$  , speed of sound in air is 343

m/s, helium density is  $0.179 \text{ kg/m}^3$  and speed of sound in helium is  $972 \text{ m/s}$ . Find the reflection coefficient, transmission coefficient and absorption coefficient (7 marks)

b) Brief about beam width and directivity index. (5 Marks)

c) What are resonators? (2 Marks)

14. a) Obtain the pressure reflection and pressure transmission coefficient for the oblique incidence of sound on a medium boundary. (10 marks)

b) Obtain the acoustic pressure developed in a pipe of length  $L$  whose one end is closed. Sound source is a vibrating piston attached to the open end of the pipe. (4 Marks)

### Module 3

15. a) With suitable figure, explain the hearing mechanism in human ear. (8 Marks)

b) With suitable example describe about perceived noise level and speech interference level (6 Marks)

16. a) Human react differently to different sounds. With suitable instances describe about human reactions to various sounds and noises (8 Marks)

b) Brief about OSHA noise exposure criteria (6 Marks)

### Module 4

17. a) Brief about reverberation chambers and anechoic chambers. Describe in detail about how measurements are done in them (10 marks)

b) Explain the working of dosimeter (4 Marks)

18. a) With the help of a neat diagram, explain the working of sound level meter (8 marks)

b) What are microphones. Brief about any one type (6 marks)

### Module 5

19. a) Describe about (8 Marks)

(i) Mufflers

(ii) Acoustic filters

b) Brief about acoustic absorbers (6 Marks)

20. a) What are bafflers. Explain how noise reduction is attained through baffler (7 Marks)

b) Discuss the ways by which noise produced by rotating machines can be controlled (7 marks)

## Syllabus

### Module 1

Introduction – Basic acoustic principles, sound pressure, acoustic velocity, particle velocity, acoustic wave equation, Plane acoustic wave, harmonic solution.

Frequency, wavelength, acoustic impedance, sound power, sound intensity, Energy density, Decibel scale – relationship between pressure, intensity and power

### Module 2

Spherical waves – radiation – simple source – hemispherical source- radiating piston – pressure intensity distribution – Beam width and directivity index

Transmission through one, two and three media – Transmission through pipes – branched and unbranched, resonators – Transmission loss- reflection at plane surface, standing waves, standing wave apparatus.

### Module 3

Ear its structure and function, Hearing Thresholds, Loudness of Sound, and Sound Adaptation, Human reaction to sound – definitions of speech interference level, perceived noise level, phon and sone, hearing loss. Noise criteria and standards – noise and number index guide lines for designing quieter equipments

### Module 4

Noise measurement- microphones, sound level meters, sound intensity probes, dosimeters, noise analyzer and graphic level recorder, spectrum Analysis, Measurement in anechoic and reverberation chambers

### Module 5

Principles of noise control, control at source, during transmission and at receiver- protection of receiver, Acoustic insulation – acoustic materials – acoustic filter and mufflers – plenum chamber, advanced acoustic absorbers

Principles of noise control in machinery such as pumps, rotating machines, reciprocating machines etc

### Text Books

1. Kinsler and frey – Fundamentals of Acoustics
2. I. L. Ver, L. L. Beranek– Noise and Vibration Control Engineering
3. Grad – Industrial noise and vibration

### Reference Books

1. Malcom J Crocker , Handbook of noise and vibration control, John Wiley & Sons, Inc.

2. Heinrich Kuttruff, Acoustics an introduction, Taylor & Francis
3. David-A Bies. Collin H Hansen, Engineering Noise control- Theory and Practice, Fourth edition, Spon press, London
4. Michael Moser, Engineering Acoustics, Springer

### Course Contents and Lecture Schedule

No	Topic	No. of Lectures
1	<b>Module 1</b>	
1.1	Introduction – Basic acoustic principles, sound pressure, acoustic velocity, particle velocity	1
1.2	Acoustic wave equation, Plane acoustic wave, harmonic solution	3
1.3	Frequency, wavelength, acoustic impedance, sound power, sound intensity, Energy density, Decibel scale – relationship between pressure, intensity and power	3
2	<b>Module 2</b>	
2.1	Spherical waves – radiation – simple source – hemispherical source- radiating piston – pressure intensity distribution – Beam width and directivity index	1
2.2	Transmission through one, two and three media	3
2.3	Transmission through pipes – branched and unbranched, resonators – Transmission loss- reflection at plane surface, standing waves, standing wave apparatus.	3
3	<b>Module 3</b>	
3.1	Ear its structure and function, Hearing Thresholds, Loudness of Sound, and Sound Adaptation	2
3.2	Human reaction to sound – definitions of speech interference level, perceived noise level, phon and sone, hearing loss	2
3.3	Noise criteria and standards – noise and number index guide lines for designing quieter equipments	3
4	<b>Module 4</b>	
4.1	Noise measurement- microphones, sound level meters, sound intensity probes, dosimeters, noise analyzer and graphic level recorder, spectrum Analysis	5
4.2	Measurement in anechoic and reverberation chambers	3
5	<b>Module 5</b>	
5.1	Principles of noise control, control at source, during transmission and at receiver- protection of receiver, Acoustic insulation –	4

	acoustic materials – acoustic filter and mufflers – plenum chamber, advanced acoustic absorbers	
5.2	Principles of noise control in machinery such as pumps, rotating machines, reciprocating machines etc	3

APJ ABDUL KALAM  
TECHNOLOGICAL  
UNIVERSITY



CODE	COURSE NAME	CATEGORY	L	T	P	CREDIT
MET446	HEAT TRANSFER EQUIPMENT DESIGN	PEC	2	1	0	3

**Preamble:** The course is designed to provide a complete design knowledge of various heat transfer equipments which are invariably used in most of the chemical process industries.

**Prerequisite:** MET204 Thermodynamics, MET302 Heat and Mass Transfer

**Course Outcomes:** After the completion of the course the student will be able to

CO 1	Analyse thermal performance of heat exchangers
CO 2	Explain performance of cooling towers
CO 3	Design heat pipes for different applications

#### Mapping of course outcomes with program outcomes

	PO 1	PO 2	PO 3	PO 4	PO 5	PO 6	PO 7	PO 8	PO 9	PO 10	PO 11	PO 12
CO 1	✓	✓	✓									
CO 2	✓	✓	✓									
CO 3	✓	✓	✓									

#### Assessment Pattern

Bloom's Category	Continuous Assessment Tests		End Semester Examination
	1	2	
Remember	10	10	20
Understand	30	30	60
Apply	10	10	20
Analyse			
Evaluate			
Create			

#### Mark distribution

Total Marks	CIE	ESE	ESE Duration
150	50	100	3 hours

**Continuous Internal Evaluation Pattern:**

Attendance	: 10 marks
Continuous Assessment Test (2 numbers)	: 25 marks
Assignment/Quiz/Course project	: 15 marks

**End Semester Examination Pattern:** There will be two parts; Part A and Part B. Part A contain 10 questions with 2 questions from each module, having 3 marks for each question. Students should answer all questions. Part B contains 2 questions from each module of which student should answer any one. Each question can have maximum 2 sub-divisions and carry 14 marks.

**Course Level Assessment Questions****Course Outcome 1 (CO1):**

1. How double pipe heat exchangers are classified
2. Explain the concept of true temperature difference in a 1-2 heat exchanger.

**Course Outcome 2 (CO2)**

1. Illustrate and explain the functions of cooling tower.
2. Explain briefly how performance evaluation of cooling towers are done .

**Course Outcome 3(CO3):**

1. Explain the working principle of heat pipes
2. Explain briefly the heat pipe design procedure.



**Model Question Paper****APJ ABDUL KALAM TECHNOLOGICAL UNIVERSITY  
EIGHTH SEMESTER B.TECH DEGREE EXAMINATION****COURSE CODE: MET446****COURSE NAME: HEAT TRANSFER EQUIPMENT DESIGN****Max. Marks: 100****Duration: 3 Hours****PART – A****(Answer all questions, each question carries 3 marks)**

1. What do you mean by compact heat exchanger and write the importance of area density in it.
2. Under what condition, the effectiveness NTU method is preferred over LMTD method as a method of analysis of Heat exchanger.
3. Are we really getting extra advantage by providing Baffles in Shell and tube heat exchanger. Justify your answer.
4. What are the causes of pressure drop in shell and tube heat exchanger?
5. How size of cooling tower and wet bulb temperature are related?
6. How do you calculate evaporation loss in cooling tower?
7. Explain the term liquid pressure drop as applicable to heat pipes
8. How effective thermal conductivity of a wick structure is determined ?
9. How heat pipes work against gravity ?
10. Write short notes on micro heat pipes.

**PART – B****(Answer one full question from each module)****MODULE – 1**

11. a) How fouling is dealt while designing heat exchangers. ( 4 Marks )  
b) A counter-flow double-pipe heat exchanger is to heat the cold fluid from 30°C to 65°C at a rate of 2 kg/s. The heating is to be accomplished by hot fluid available at 100°C at a mass flow rate of 1 kg/s. The inner tube is thin-walled and has a diameter of 1.5 cm. Specific heat of the hot fluid is 10kJ/kgK and that of the cold fluid is 5 kJ /kgK. If the overall heat transfer coefficient of the heat exchanger is 640 W/m<sup>2</sup> °C, determine the length of the heat exchanger required to achieve the desired heating. (10 Marks )

OR

- 12 a) Derive the effectiveness of counter flow heat exchanger ( 8 Marks )
- b) What would be the effectiveness of counter flow heat exchanger if  $C_{min}/C_{max} = 0$  and  $C_{min}/C_{max}=1$  (6 Marks )

**MODULE – 2**

13. The condenser of a large steam power plant is a heat exchanger in which steam is condensed to liquid water. Assume the condenser to be a shell-and-tube heat exchanger consisting of a single shell and 30,000 tubes, each executing two passes. The tubes are of thin wall construction with  $D=25$  mm, and steam condenses on their outer surface with an associated convection coefficient of  $h_0=11,000$  W/m.K the heat transfer rate that must be effected by the exchanger is  $q=2 \times 10^9$  W, and this is accomplished by passing cooling water through the tubes at a rate of  $3 \times 10^4$  kg/sec. the water enters at  $20^\circ\text{C}$  while the steam condenses at  $50$  degree C. What is the temperature of the cooling water emerging from the condenser? What is the required tube length  $L$  per pass? ( 14 Marks)

OR

14. a) Draw rough sketch of temperature distribution curve for condenser and evaporator type heat exchangers. Derive the expression for overall heat transfer coefficient for shell and tube type heat exchanger (7 marks)
- b) A heat exchanger is to be designed to condensate  $8$  kg/s of an organic liquid having saturation temperature  $80^\circ\text{C}$  and  $h_{fg} = 600$ kJ/kg. Cooling water is available at  $15^\circ\text{C}$  and at a flow rate of  $60$  kg/s. The overall heat transfer co-efficient is  $480$  W/m<sup>2</sup> -K. Determine: (1) The number of tubes required if tubes are to be  $2$ mm thick,  $4.85$  m in length and  $25$ mm OD. (2) No.s of tube passes if limiting velocity of cooling water is  $2$  m/s. (7 marks)

**MODULE – 3**

15. a) Explain different types of cooling towers (8 marks)
- b) Explain the terms a) Cooling range b) Approach and c) Effectiveness as applied to a cooling tower (6 marks)

OR

16. a) Write about the importance of wet bulb temperature in cooling towers? (7 marks)
- b) What is the effect of change in heat load on cooling tower performance? Explain. (7 marks)

**MODULE – 4**

17. Write short notes on a ) Working fluids b ) Wick Structures as applicable to heat pipes? (14 marks)

OR

18. Explain briefly capillary, sonic, entrainment and boiling limitations applied to heat pipes  
(14 marks)

### MODULE – 5

19. Explain how fluid selection, wick selection and material selection are done in a heat pipe design.  
(14 marks)

OR

20. Write brief notes on Non conventional heat pipes  
(14 marks)

### Syllabus

#### Module 1

Thermal performance analysis of heat exchangers - compact, cross flow, liquid to gas, and double pipe heat exchangers, film coefficients for tubes and annuli, equivalent diameter of annuli, fouling factors, caloric or average fluid temperature, true temperature difference; Design calculation of double pipe heat exchanger, double pipe exchangers in series-parallel arrangements.

#### Module 2

Shell and tube heat exchangers - tube layouts, baffle spacing, classification of shell and tube exchangers, Design calculation of shell and tube heat exchangers, shell-side film coefficients, shell-side equivalent diameter, true temperature difference in a 1-2 heat exchanger, performance analysis of 1-2 heat exchangers, flow arrangements for increased heat recovery.

#### Module 3

Direct contact heat transfer - Classification of cooling towers, wet-bulb and dew point temperatures, Lewis number, cooling-tower internals, heat balance, heat transfer by simultaneous diffusion and convection; Design and analysis of cooling towers, determination of the number of diffusion units, performance evaluation of cooling towers, influence of process conditions and operating variables on their design .

#### Module 4

Heat pipes - types and applications, operating principles, working fluids, wick structures, control techniques, pressure balance, maximum capillary pressure, liquid and vapor pressure drops, effective thermal conductivity of wick structures, capillary limitation on heat transport capability, sonic, entrainment, and boiling limitations, determination of operating conditions

#### Module 5

Heat pipe design – fluid selection, wick selection, material selection, preliminary design considerations, heat pipe design procedure, determination of heat pipe diameter, design of heat pipe containers, wick design, entrainment and boiling limitations, design problems;

Non conventional heat pipes – flat, rotating, reciprocating and disc shaped heat pipes, heat pipes in cooling microelectronics – micro and mini heat pipes.

### Text Books

- 1 Kern, D. Q., Process Heat Transfer, Tata McGraw-Hill, 2000.
2. Chi, S. W., Heat Pipe Theory and Practice- A Source Book, McGraw-Hill, 1976
3. Fraas, A. P., Heat Exchanger Design, Second Edition, John Wiley & Sons, 1989

### Reference Books

1. R K Shah, Fundamentals of Heat Exchanger Design, John Wiley & Sons.
2. Dunn, P. D. and Reay, D. A., Heat Pipes, Fourth Edition, Pergamon Press, 1994.
3. Das, S.K., Process heat transfer, Narosa publishing house.2005

### Course Contents and Lecture Schedule

No	Topic	No. of Lectures
1.1	Thermal performance analysis of heat exchangers - compact, cross flow, liquid to gas, and double pipe heat exchangers,	2
1.2	Film coefficients for tubes and annuli, equivalent diameter of annuli, fouling factors, caloric or average fluid temperature, true temperature difference; Design calculation of double pipe heat exchanger	3
1.3	Double pipe exchangers in series-parallel arrangements.	2
2.1	Shell and tube heat exchangers - tube layouts, baffle spacing, classification of shell and tube exchangers, Design calculation of shell and tube heat exchangers, shell-side film coefficients, shell-side equivalent diameter, true temperature difference in a 1-2 heat exchanger,	4
2.2	performance analysis of 1-2 heat exchangers, flow arrangements for increased heat recovery.	3
3.1	Direct contact heat transfer - Classification of cooling towers, wet-bulb and dew point temperatures, Lewis number, cooling-tower internals, heat balance, heat transfer by simultaneous diffusion and convection;	3
3.2	Design and analysis of cooling towers, determination of the number of diffusion units, performance evaluation of cooling towers, influence of process conditions and operating variables on their design .	4
4.1	Heat pipes - types and applications, operating principles, working fluids, wick structures, control techniques, pressure balance, maximum capillary pressure, liquid and vapor pressure drops, effective thermal conductivity of wick structures,	3
4.2	capillary limitation on heat transport capability, sonic,	3

	entrainment, and boiling limitations, determination of operating conditions	
5.1	Heat pipe design – fluid selection, wick selection, material selection, preliminary design considerations, heat pipe design procedure, determination of heat pipe diameter, design of heat pipe containers, wick design, entrainment and boiling limitations,	5
5.2	design problems; Non conventional heat pipes – flat, rotating, reciprocating and disc shaped heat pipes, heat pipes in cooling microelectronics – micro and mini heat pipes.	3



CODE	COURSE NAME	CATEGORY	L	T	P	CREDIT
MET456	ROBOTICS AND AUTOMATION	PEC	2	1	0	3

**Preamble:** The objective of this course is

- To know the wide applications of Robotic technology in various domains
- To familiarize various robot sensors and their perception principles that enable a robot
- To get a basic understanding about the kinematics and dynamics of robot.

**Course Outcomes:** After the completion of the course the student will be able to

CO 1	Explain the concept, development and key components of robotics.
CO 2	Apply the mathematics used to describe positions and orientations in space.
CO 3	Solve numerical problems in the statics and dynamics of robotic models.
CO 4	Explain various robot sensors and their perception principles.

**Mapping of course outcomes with program outcomes**

	PO 1	PO 2	PO 3	PO 4	PO 5	PO 6	PO 7	PO 8	PO 9	PO 10	PO 11	PO 12
CO 1	3	3	3									2
CO 2	3	3	3									2
CO 3	3	3	3									2
CO 4	3	3	3									2

**Assessment Pattern**

Bloom's Category	Continuous Assessment Tests		End Semester Examination
	1	2	
Remember			
Understand	30	30	60
Apply	20	20	40
Analyse			
Evaluate			
Create			

**Mark distribution**

Total Marks	CIE	ESE	ESE Duration
150	50	100	3 hours

**Continuous Internal Evaluation Pattern:**

Attendance	: 10 marks
Continuous Assessment Test (2 numbers)	: 25 marks
Assignment/Quiz/Course project	: 15 marks

**End Semester Examination Pattern:** There will be two parts; Part A and Part B. Part A contain 10 questions with 2 questions from each module, having 3 marks for each question. Students should answer all questions. Part B contains 2 questions from each module of which student should answer any one. Each question can have maximum 2 sub-divisions and carry 14 marks.

**Course Level Assessment Questions****Course Outcome 1 (CO1):**

1. Describe the major elements of an industrial robot.
2. What is work volume?
3. Compare pneumatic drive robots with stepper motor drive robot.

**Course Outcome 2 (CO2)**

1. Define base and tool coordinate systems.
2. Determine the translated vector for the given vector  $v=25i+10j+20k$ , perform a translation by a distance of 8 units in “X” direction, 5 units in “Y” direction and 0 units in “Z” direction.
3. Explain any two commands associated with the programming of end effectors.

**Course Outcome 3 (CO3):**

1. Describe briefly the dynamics of a robot.
2. A single-link robot with a rotary joint is motionless at  $\theta=-50^\circ$ . It is desired to move the joint in a smooth manner to  $\theta = 80^\circ$  in 4 seconds. Find the coefficients of a cubic which accomplishes this motion and brings the arm to rest at the goal.
3. Write a critical note on forward kinematics of a 2 degrees of freedom robot.

**Course Outcome 4 (CO4):**

1. Differentiate between the sensor & transducer.
2. Explain the working principle of inductive proximity sensor.
3. What are the applications of machine vision system?

**Model Question Paper**

Max. Marks: 100

Duration: 3 Hours

**PART A (30 marks)***Answer all questions, each carries 3 marks.*

1. Briefly explain the need of robots in healthcare.
2. Explain the working of a UAV.
3. Differentiate between open and closed kinematic chain with the help of examples.
4. What is the difference between internal grippers and external grippers?
5. Define the singularities of a mechanism.
6. How will you obtain the dynamic model of a robot?
7. Explain the need of mapping in the kinematics of robots.
8. What is trajectory planning in robotics?
9. Briefly explain the function of a LVDT.
10. What are the applications of machine vision system?

**PART B (70 marks)***Answer any one question from each module, each carries 14 marks.***Module 1**

11. a) Classify the industrial robots and briefly describe it. (7)
- b) Explain the various parts of a robot with neat sketch. (7)
12. a) Explain the working of DC servo motors used in robotics. (7)
- b) Discuss about the salient features of servo motor with limitations. (7)

**Module 2**

13. a) Explain RRR and RPR mechanism. (8)
- b) Explain actuator space, joint space and Cartesian space of a manipulator. (6)
14. Explain the different types of frames used in robot motion. (14)

**Module 3**

15. a) What are the four parameters in DH representation? Explain how they are determined? (8)
- b) If the two links of a two-link planar manipulator have equal lengths, find out the expression for the homogeneous transformation matrix. (6)
16. Illustrate the forward and reverse kinematics of a robot with an example. (14)

**Module 4**

17. Obtain equations of dynamics for 2-R manipulator using lagrangian method. (14)
18. a) Explain the propagation of velocity from link to link in a manipulator. (8)
- b) Explain the joint space and cartesian space descriptions of robot trajectory (6)

**Module 5**

19. a) Describe the classification of sensors and the factors to be considered for its selection. (7)
- b) Describe force sensing with strain gauge and wrist force sensor. (7)
20. a) Explain the segmentation methods used in vision system with suitable example. (7)
- b) Describe any one algorithm for image edge detection with advantages. (7)

Estd.



2014

## Syllabus

### Module 1 (7 hours)

Introduction: History and evolution of Robotics, Industrial Robots, Field and Service Robots, Wheeled Mobile Robots, Underwater Robots, remotely operated vehicles, Autonomous Underwater Vehicle, Robotics for Healthcare, Rehabilitation Robotics, Aerial Robotics, Domestic Robots. Components of a Robot: Mechanical systems, Electrical systems. Robot drive systems: Pneumatic Drives – Hydraulic Drives – Mechanical Drives – Electrical Drives – D.C. Servo Motors, Stepper Motor, A.C. Servo Motors – Salient Features. Applications.

### Module 2 (7 hours)

Spatial description and Transformations: Description of Position and Orientation, Rotation matrix, Euler angles, Frames and Displacement mappings, Homogeneous transforms, Transformation of free vectors.

Robot Manipulator: Manipulator joints- linear and rotary, Types. Link description, Link-connection description. Robot architecture, Convention for affixing frames to links, reference frames, degree of freedom. Common body and arm configurations in industrial robots- Cartesian, polar, cylindrical, jointed arm, SCARA. Wrist assembly- end effector, Mechanical gripper.

### Module 3 (7 hours)

Robot Kinematics: Robot Coordinates- global and tool coordinates. Link and joint parameters Denavit and Hartenberg convention, DH algorithm. Typical examples of forward and Inverse Kinematics problem.

General considerations in trajectory description and generation: joint-space schemes, Cartesian-space schemes.

### Module 4 (7 hours)

Robot statics: motion of the links of a robot, velocity propagation from link to link, geometric Jacobian, Jacobian computation, kinematic singularities, static forces in manipulators, Jacobians in the force domain, Cartesian transformation of velocities and static forces.

Robot Dynamics: manipulator dynamic equations, Lagrangian formulation of manipulator dynamics, dynamical model of simple manipulator structures.

### Module 5 (7 hours)

Sensors and machine vision: Requirements of a sensor, Principles and Applications of the following types of sensors – Position of sensors (Piezo Electric Sensor, LVDT, Resolvers, Optical Encoders), Range Sensors (Triangulation Principle, Structured, Lighting Approach, Laser Range Meters).

Proximity Sensors (Inductive, Capacitive and Ultrasonic), Touch Sensors, (Binary Sensors, Analog Sensors), Wrist Sensors, Compliance Sensors, Slip Sensors. Camera, Frame Grabber, Sensing and Digitizing Image Data – Signal Conversion, Image Storage, Lighting Techniques.

**Text/Reference Books**

1. Craig, J.J., Introduction to Robotics: Mechanics and Control, Pearson Education India; 3<sup>rd</sup> edition ,2008.
2. M.P.Groover, Industrial Robotics – Technology, Programming and Applications, McGraw-Hill, 2001.
3. Fu.K.S., Gonzalz.R.C. and Lee C.S.G., Robotics Control, Sensing, Vision and Intelligence, McGraw-Hill Book Co., 1987
4. Janakiraman.P.A., Robotics and Image Processing, Tata McGraw-Hill, 1995.

**Course Contents and Lecture Schedule**

No	Topic	No. of Lectures
<b>1</b>	<b>Introduction to robotics</b>	
1.1	History and evolution of Robotics, Industrial Robots, Field and Service Robots.	1
1.2	Wheeled Mobile Robots, Underwater Robots, remotely operated vehicles, Autonomous Underwater Vehicle	1
1.3	Robotics for Healthcare, Rehabilitation Robotics	1
1.4	Aerial Robotics, Domestic Robots. Components of a Robot: Mechanical systems, Electrical systems.	1
1.5	Pneumatic Drives – Hydraulic Drives –Mechanical Drives – Electrical Drives	1
1.6	D.C. Servo Motors, Stepper Motor	1
1.7	A.C. Servo Motors	1
<b>2</b>	<b>Robot Manipulator</b>	
2.1	Spatial description and Transformations: Description of Position and Orientation, Rotation matrix, Euler angles.	1
2.2	Frames and Displacement mappings, Homogeneous transforms.	1
2.3	Transformation of free vectors.	1
2.4	Robot Manipulator: Manipulator joints- linear and rotary, Types. link description, link-connection description.	1
2.5	Robot architecture, convention for affixing frames to links, reference frames, degree of freedom.	1
2.6	Common body and arm configurations in industrial robots- cartesian, polar, cylindrical, jointed arm, SCARA.	1
2.7	Wrist assembly-end effector, Mechanical gripper.	1
<b>3</b>	<b>Robot Kinematics</b>	
3.1	Global and tool coordinates. Link and joint parameters.	1
3.2	Denavit and Hartenberg convention.	1

3.3	DH algorithm.	1
3.4	Examples of forward Kinematics of planar robots.	1
3.5	Inverse manipulator kinematics. Solvability. Algebraic vs Geometric Solutions	1
3.6	Inverse Kinematics of RR and RP planar manipulators	1
3.7	General considerations in trajectory description and generation: joint-space schemes, cartesian-space schemes	1
<b>4 Robot Statics and Dynamics</b>		
4.1	Motion of the links of a robot, velocity propagation from link to link,	1
4.2	Geometric Jacobian, Jacobian computation	1
4.3	Kinematic singularities	1
4.4	Static forces in manipulators, Jacobians in the force domain.	1
4.5	Cartesian transformation of velocities and static forces.	1
4.6	Lagrangian formulation of manipulator dynamics.	1
4.7	Dynamical model of 2 DOF planar manipulators	1
<b>5 Sensors and machine vision system</b>		
5.1	Requirements of a sensor, Piezo Electric Sensor, LVDT, Resolvers, Optical Encoders.	1
5.2	Range Sensors, Triangulation Principle, Structured, Lighting Approach, Laser Range Meters.	1
5.3	Proximity Sensors-Inductive, Capacitive and Ultrasonic.	1
5.4	Touch Sensors, (Binary Sensors, Analog Sensors), Wrist Sensors, Compliance Sensors, Slip Sensors.	1
5.5	Camera, Frame Grabber.	1
5.6	Sensing and Digitizing Image Data – Signal Conversion.	1
5.7	Image Storage, Lighting Techniques.	1

CODE	COURSE NAME	CATEGORY	L	T	P	CREDIT
MET466	TECHNOLOGY MANAGEMENT	PEC	2	1	0	3

**Preamble:** Management of innovation and technology is important an organisation. This course is designed to facilitate the students to understand the concept of technology management, Key issues in managing technology. This course will also help the students to gain a fair understanding on contemporary topics in technology and innovation management.

**Prerequisite:** NIL

**Course Outcomes:** After the completion of the course the student will be able to

CO 1	Be conversant with important terms for technology management in organisations
CO 2	Explain the need of technology forecasting
CO 3	Understand the essence of technology acquisition
CO 4	Describe the elements of technology strategy
CO 5	Outline the basics of innovation
CO 6	Identify human factors in technology management

**Mapping of course outcomes with program outcomes**

	PO 1	PO 2	PO 3	PO 4	PO 5	PO 6	PO 7	PO 8	PO 9	PO 10	PO 11	PO 12
CO 1	3					2					2	1
CO 2	2		2								2	2
CO 3	2					2						2
CO 4	3					2						2
CO 5	3					2					2	2
CO 6	2					2						2

**Assessment Pattern**

Bloom's Category	Continuous Assessment Tests		End Semester Examination (in %)
	1 (in %)	2 (in %)	
Remember	20	20	20
Understand	60	40	40
Apply	20	40	40
Analyse			
Evaluate			
Create			

**Mark distribution**

<b>Total Marks</b>	<b>CIE Marks</b>	<b>ESE Marks</b>	<b>ESE Duration</b>
150	50	100	3 hours

**Continuous Internal Evaluation Pattern:**

Attendance	: 10 marks
Continuous Assessment Test (2 numbers)	: 25 marks
Assignment/Quiz/Course project	: 15 marks

**End Semester Examination Pattern:** There will be two parts; Part A and Part B. Part A contain 10 questions with 2 questions from each module, having 3 marks for each question. Students should answer all questions. Part B contains 2 questions from each module of which student should answer any one. Each question can have maximum 2 sub-divisions and carry 14 marks.

**Course Level Assessment Questions****Course Outcome 1 (CO1):**

1. Distinguish between process technology and product technology
2. What are the impacts of technology on society?
3. Describe the significance of technology management.

**Course Outcome 2 (CO2)**

1. Describe the need of technology forecasting.
2. List out technology forecasting methods.
3. Describe characteristics of technology forecasting.

**Course Outcome 3(CO3):**

1. What is technology acquisition?
2. With examples, describe the process of managing acquired technology.
3. Describe the importance of technology generation.

**Course Outcome 4 (CO4):**

1. What are the constraints in technology absorption?
2. What are elements of technology strategy?

3. Describe the science and technology policy in India

**Course Outcome 5 (CO5):**

1. Differentiate between invention and innovation.
2. Describe the importance of innovation in product lifecycle
3. Enumerate the importance of trademarks.

**Course Outcome 6 (CO6):**

1. Explain the challenges of automation in India
2. What are the HR issues in R&D?
3. What are the different organisational factors to be considered in technology management.

**Model Question Paper**

**APJ ABDUL KALAM TECHNOLOGICAL UNIVERSITY  
EIGHTH SEMESTER B.TECH DEGREE EXAMINATION**

**COURSE CODE: MET466      COURSE NAME: TECHNOLOGY MANAGEMENT**

Max. Marks: 100

Duration: 3 Hours

**PART A**

**Answer ALL questions, each carries 3 marks.**

1. Describe the impact of technology in competition
2. Distinguish between process technology and product technology
3. What is technology acquisition?
4. Describe the need of technology forecasting.
5. How technology absorption improves competitiveness?
6. Describe the benefits of technology absorption
7. How is R&D affects production costs?
8. Describe the role of government in innovation.
9. How does organisational structure affect technology?
10. What are the HR issues in R&D?

**PART B**

11. What are the elements of technological innovation? Explain with examples (14)  
OR
12. Enumerate the impact of technology on society (14)
13. Describe characteristics of technology forecasting. (14)

OR

14. With examples, describe the process of managing acquired technology. (14)

15. Describe the constraints in technology absorption (14)

OR

16. What are the different elements of science and technology policy in India (14)

17. With the aid of examples, describe how innovation helps new product development (14)

OR

18. What are the different remedial measures against infringement (14)

19. Describe various human factors to be considered in technology management. (14)

OR

20. Describe the challenges of automation in India. (14)

### Syllabus

#### Module 1

**Technology and Technology Management** - Technology- evolution and growth of technology, technology management: concepts and definitions, role and significance of technology management, impact of technology on society and business. Technology and competition, organizing technology at the enterprise level, key issues in managing technological innovation and forms of technology- process technology, product technology.

#### Module 2

**Technology Acquisition and Technology Forecasting** - Technology acquisition, new technology, alternatives for acquiring new technologies, management of acquired technology, technology forecasting, characteristics of technology forecasting, technology forecast methods, principles of technology forecasting, technology forecasting process, need and role of technology forecasting, forecasting methods and techniques, planning and forecasting. Technology generation and development, technology generation, process, technology development, importance of technology generation and development.

#### Module 3

**Technology strategy and management** - Need for technology strategy, technology adoption, diffusion, absorption and competitiveness, elements of technology strategy, role of technology absorption, benefits of technology absorption, constraints in technology absorption, technology package and technological dependence, Indian experience in technology absorption efforts, issues involved in the management of technology absorption and government initiatives, technology policies, science and technology policy in India.

**Module 4**

**Management of R&D and innovation** - Importance of Research and Development (R&D), corporate research and product lifecycle, production costs and R&D, translation of R&D efforts to technology, innovation, types of innovation, difference between innovation and invention, framework for management of innovation, organizational characteristics that facilitate innovation, trademarks, copyrights, patents and their use in innovation management, remedy against infringement, the role of technology transfer in innovation and new product development, role of government in innovation, globalisation and innovations, technology and innovation management - case studies about management of R&D and innovation.

**Module 5**

**Human Aspects in Technology Management** - Integration of people and technology, human factors to be considered in technology management - organisational factors and psychological factors, organisational structure and technology, implications of technological change, implementation of rationalization and automation in India, impact of technological change, human resource management issues in R&D and innovation, technology assessment and environmental impact analysis

**Text Books**

1. P N Rastogi, Management of Technology and Innovation: Competing Through Technological Excellence, SAGE Publications, 2009
2. Tushman, M.L. and Anderson ,P., Managing Strategic Innovation & Change, Oxford University Press, New York, 2004.
3. Khurana, V. K., Management of Technology and Innovation, Ane Books New Delhi, 2012
4. Narayanan, V. K, Managing Technology and Innovation for Competitive Advantage, Pearson Education, 2002
5. Ettore, J. E, Managing Innovation: New technology, New Products and New Services in a Global Economy, A Butterworth-Heinemann Title, 2006

**Reference Books**

1. Afuah, A, Innovation Management, Strategies, Implementation and Profits, Oxford University Press, 2009
2. Paul Trott, Innovation Management and New Product Development, Pearson Education, 2004.
3. Robert A Burgelman, Clayton.M.Christensen, Steven.C.Wheelright, Strategic Management of Technology and Innovation (Fifth Edition), McGraw-Hill Education, 2009

### Course Contents and Lecture Schedule

No	Topic	No. of Lectures
1	<b>Technology and Technology Management</b>	
1.1	Technology- evolution and growth of technology	1
1.2	Technology management: concepts and definitions, role and significance of technology management	1
1.3	Impact of technology on society and business. technology and competition, organizing technology at the enterprise level	2
1.3	Key issues in managing technological innovation	1
1.3	Forms of technology- process technology, product technology.	1
2	<b>Technology Acquisition and Technology Forecasting</b>	
2.1	Technology acquisition, new technology, alternatives for acquiring new technologies, management of acquired technology	2
2.2	Technology forecasting, characteristics of technology forecasting, technology forecast method, principles of technology forecasting, technology forecasting process, need and role of technology forecasting, forecasting methods and techniques, planning and forecasting.	3
2.3	Technology generation and development, technology generation-process, technology development, importance of technology generation and development.	2
3	<b>Technology strategy and management</b>	
3.1	Need for technology strategy, technology adoption, diffusion, absorption and competitiveness, elements of technology strategy	2
3.2	Role of technology absorption, benefits of technology absorption, constraints in technology absorption, technology package and technological dependence, Indian experience in technology absorption efforts.	3
3.3	Issues involved in the management of technology absorption, government initiatives, technology policies - science and technology policy in India.	2
4	<b>Management of R&amp;D and Innovation</b>	
4.1	Importance of Research and Development (R&D), corporate research and product lifecycle, production costs and R&D, translation of R&D efforts to technology.	2
4.2	Innovation, types of innovation, difference between innovation and invention,	2
4.3	Framework for management of innovation, organizational characteristics that facilitate innovation,	1
4.4	Trademarks, copyrights, patents and their use in innovation	1

	management, remedy against infringement,	
4.5	The role of technology transfer in innovation and new product development, role of government in innovation, globalisation and innovations, technology and innovation management.	2
4.6	Case studies about management of R&D and innovation.	1
5	<b>Human Aspects in Technology Management</b>	
5.1	Integration of people and technology, factors to be considered in technology management, organisational factors and psychological factors	2
5.2	Organisational structure and technology, implications of technological change	2
5.3	Implementation of rationalization and automation in India, impact of technological change	1
5.4	Human resource management issues in R&D and innovation, technology assessment and environmental impact analysis	2

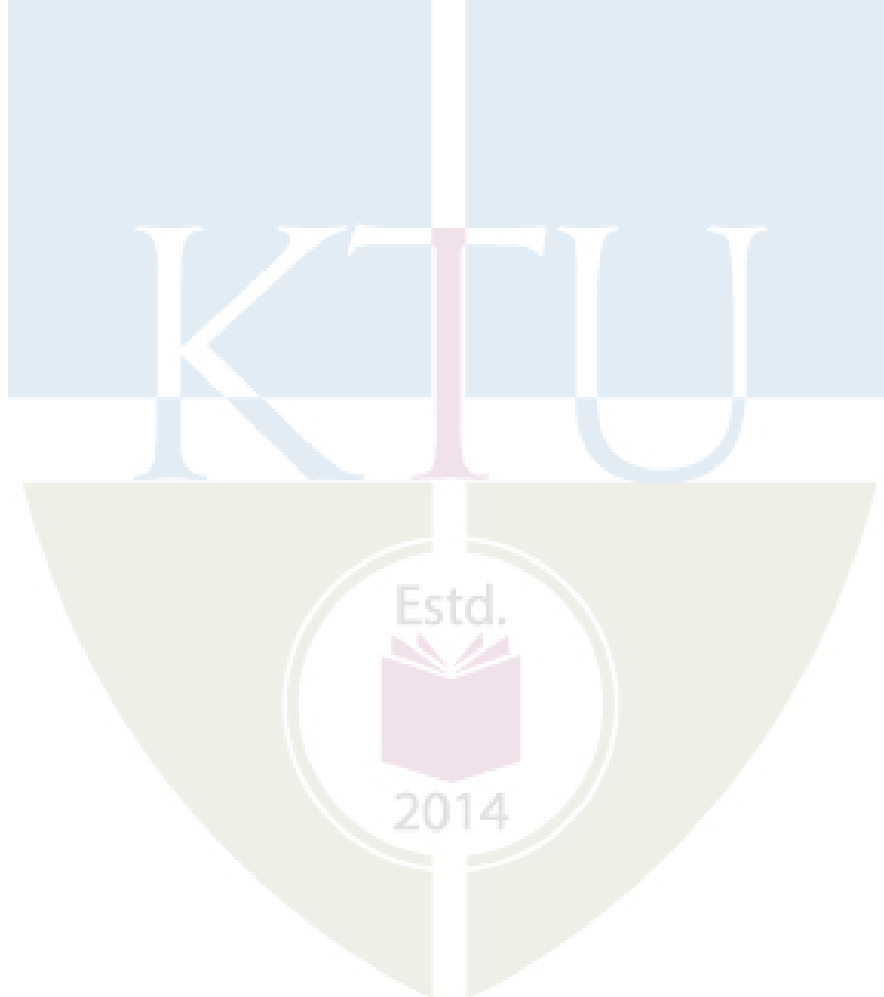

CODE	COURSE NAME	CATEGORY	L	T	P	CREDIT
MET476	CRYOGENIC ENGINEERING	PEC	2	1	0	3

**Preamble:** This course provides fundamental knowledge of types of cryogenic fluids, behavior of materials and properties at temperatures, liquefaction systems, cryogenic refrigeration, gas separation, purification, insulators, cryogenic storage, transfer and measuring instruments

**Prerequisite:** MET202-Engineering Thermodynamics, MET303-Thermal Engineering

**Course Outcomes :**After completion of the course the student will be able to

CO1	Explain the properties of cryogenic liquids and properties of material at cryogenic temperatures
CO2	Describe and analyze cryogenic liquefaction systems using first principles of thermodynamics
CO3	Describe and analyze cryogenics refrigeration using first principles of thermodynamics
CO4	Identify insulation system for cryogenic application and explain cryogenic storage vessels.
CO5	Understand gas separation and purification methods
CO6	Understand instrumentation for various measurements in cryogenic engineering.

**Mapping of course outcomes with program outcomes**

	PO 1	PO 2	PO 3	PO 4	PO 5	PO 6	PO 7	PO 8	PO 9	PO 10	PO 11	PO 12
CO 1	3	2	1									
CO 2	3	2										
CO 3	3	2	1									
CO 4	3	1										
CO 5	3	1										

**Assessment Pattern**

Bloom's Category	Continuous Assessment Tests		End Semester Examination (in %)
	1 (in %)	2 (in %)	
Remember	10	10	10
Understand	20	20	20
Apply	20	20	70
Analyse			
Evaluate			
Create			

**Mark distribution**

<b>Total Marks</b>	<b>CIE Marks</b>	<b>ESE Marks</b>	<b>ESE Duration</b>
150	50	100	3 hours

**Continuous Internal Evaluation Pattern:**

Attendance	: 10 marks
Continuous Assessment Test (2 numbers)	: 25 marks
Assignment/Quiz/Course project	: 15 marks

**End Semester Examination Pattern:** There will be two parts; Part A and Part B. Part A contain 10 questions with 2 questions from each module, having 3 marks for each question. Students should answer all questions. Part B contains 2 questions from each module of which student should answer any one. Each question can have maximum 2 sub-divisions and carry 14 marks.

**Course Level Assessment Questions:****Course Outcome 1 (CO1):**

1. Describe in detail the variation of mechanical properties of various materials at cryogenic temperatures
2. Explain the terms i) Transition temperature and ii) Critical current of superconductors.
3. Explain the application of cryogenics in space technology.

**Course Outcome 2 (CO2):**

1. Explain the production of low temperatures using Joule-Thomson effect.
2. How the cryo coolers are classified? Explain the working of strilling cycle cryo cooler.
3. Explain about the working of a precooled Linde-Hampson system with suitable diagram for neon and hydrogen.

**Course Outcome 3 (CO3):**

1. Explain the working of Vuilleumier refrigerator with neat sketch.
2. Explain briefly the importance of refrigerator effectiveness.
3. Explain refrigerators using solids as working media.

**Course Outcome 4 (CO4):**

1. Explain about the basic design parameters of cryogenic fluid storage vessels.
2. Explain the different types and use of insulations in cryogenic applications.
3. Explain about the cryogenic fluid transfer system.

**Course Outcome 5 (CO5):**

1. Explain the pressure measurement system used in cryogenic applications.
2. Explain the working principle of different types of cryogenic liquid level indicators.
3. Explain different temperature measuring techniques used in cryogenic applications.

**Model Question Paper**

**APJ ABDUL KALAM TECHNOLOGICAL UNIVERSITY**

**VIII SEMESTER B.TECH DEGREE EXAMINATION**

**MET476: CRYOGENIC ENGINEERING**

**Maximum: 100 Marks**

**Duration: 3 hours**

**PART A**

**Answer all questions, each question carries 3 marks**

1. Explain the historical development of cryogenics?
2. Distinguish between Ortho Hydrogen and Para Hydrogen.
3. Explain Meissner effect?
4. Explain Joule Thomson coefficient.
5. What are the performance parameters to be considered in gas liquefaction systems?
6. Define FOM for the refrigerator.
7. What is vapour shielding in cryogenic vessels?
8. What are super insulations?
9. Write a short note on hydrostatic liquid level gauge.
10. List few heat exchangers used in cryogenic systems.

(10 X 3 = 30 marks)

**PART B**

**Answer one full question from each module**

**Module 1**

11. a) What is cryogenics? Mention the few areas involving cryogenic engineering  
(7 marks)
- b) Determine the thermal conductivity of air at 250 K and 101.3 kPa if the mean free path of air at this condition is 49 nm, the gas constant for air is 287 J/kg K, the specific heat ratio is 1.4 and the specific heat at constant volume is 716.5 J/kg K.  
(7 marks)
12. a) With sketches, explain the different critical components present in gas liquefaction systems.  
(7 marks)

- b) With the help of a T-s diagram explain working of a Simon Helium liquefier. (7 marks)

### Module 2

13. a) Compare Claude Liquefaction system and Linde Hampson Liquefaction systems. (4 marks)
- b) Explain the Joule Thomson effect. Show the inversion curve of a real gas on a T-p diagram. Prove that an ideal gas will not experience a temperature change upon isenthalpic expansion. (10 marks)
14. a) With sketches, explain the different critical components present in gas liquefaction systems. (7 marks)
- b) With the help of a T-s diagram explain working of a Simon Helium liquefier. (7 marks)

### Module 3

15. a) Explain the working of a dilution refrigerator with neat schematic. (7 marks)
- b) With the help of schematic and T-S diagram, explain Philips Refrigerator. Also explain briefly the importance of refrigerator effectiveness. (7 marks)
16. a) What are the gas purification methods? With sketches, explain adsorption purifier along with refrigerator purifier. (7 marks)
- b) With sketches, explain Linde single column gas separation system. (7 marks)

### Module 4

17. a) With sketches, explain the cryogenic fluid storage vessels. (7 marks)
- b) Write about vacuum insulation and opacified powder insulation used in cryogenics. (7 marks)
18. a) Explain about cryogenic fluid transfer systems. (7 marks)
- b) With Sketch, explain the functions of different components in a Dewar vessel. (7 marks)

### Module 5

19. a) Explain the working of a turbine flow meter. (7 marks)
- b) Write short notes on the various heat exchanger configurations used in cryogenic systems. (7 marks)

20. a) Explain the different temperature measurement techniques used in cryogenic application (7 marks)
- b) Explain different safety devices used in cryogenic liquid storage systems. (7 marks)

## Syllabus

### Module 1

Introduction to cryogenic engineering, Historical background - Major events in the development of cryogenic engineering, Low Temperature properties of Engineering Materials - Mechanical properties- Thermal properties- Electric and magnetic properties, Cryogenic fluids and their properties.

Applications of cryogenics: Applications in space, food processing, super conductivity, electrical power, biology, medicine, electronics and cutting tool industry.

### Module 2

Liquefaction systems – System performance parameters, ideal liquefaction system, Joule-Thomson expansion, Adiabatic expansion, Liquefaction systems for gases other than Neon. Hydrogen and Helium. Simple Linde - Hampson system, Claude & Cascaded System.

Liquefaction systems for Neon. Hydrogen and Helium – LN<sub>2</sub> precooled Linde Hampson and Claude systems, Ortho to Para conversion arrangement in hydrogen liquefaction system, Simon Helium liquefaction system, Collins Helium liquefaction system. Critical components of Liquefaction systems – critical components and their effect on system performance.

### Module 3

Cryogenic Refrigeration systems: Ideal isothermal and isobaric refrigeration systems- Refrigeration using liquids as refrigerant- Linde-Hampson refrigerator, Claude refrigerator. Refrigeration using gases as refrigerant- Stirling cycle cryocoolers, Philips refrigerator, Effect of regenerator effectiveness on performance of Philips refrigerator, Gifford McMahon refrigerators. Refrigerators using solids as working media-Magnetic refrigerators – Thermodynamics of magnetic refrigerators, dilution refrigerators.

### Module 4

Gas separation and purification: - Thermodynamic ideal separation system, mixture characteristics, principle of gas separation, separation of air, hydrogen and helium, gas purification methods

Cryogenic fluid storage and transfer systems:, Cryogenic fluid storage vessel, Thermal insulation and their performance at cryogenic temperatures, Super Insulations, Vacuum insulation, Powder insulation, Cryogenic fluid transfer systems, Cryo pumping.

### Module 5

Cryogenic instrumentation, Pressure measurement – McLeod gauge, Pirani gauge and Penning gauge, Flow measurement – Orifice meter, Venturi meter and Turbine flow meter. Liquid level gauges- hydrostatic, resistance gauge,, capacitance gauge and

thermodynamic gauge, Temperature measurements- ITS-90, Thermocouple, RTD, magnetic thermometers and vapor pressure thermometers, Types of heat exchangers used in cryogenic systems, Safety in cryogenic fluid handling, storage and use.

**Text Books:**

1. Randal F. Barron, Cryogenic systems, McGraw Hill, 1986
2. M Mukhopadhyay, Fundamentals of Cryogenic Engineering, PHI Learning , 2010
3. K. D. Timmerhaus and T. M. Flynn, Cryogenic Process Engineering, Springer, 2013
4. S.S Thipse, Cryogenics, Narrosa, 2012

**Reference Books:**

1. A. R. Jha, Cryogenic Technology and applications, Elsevier Science, 2011
2. R. B. Scott, Cryogenic Engineering, Van Nostrand Co., 1989
3. M. D. Atrey (Ed.) Cryocoolers: Theory and Applications, 1st ed., International Cryogenics Monograph Series, Springer International Publishing, 2020

**Course Contents and Lecture Schedule**

No.	Topic	No. of Lectures
<b>1</b>	<b>Module 1</b>	
<b>1.1</b>	Introduction to Cryogenic Systems, Historical development, Low Temperature properties of Engineering Materials, Mechanical properties- Thermal properties- Electric and magnetic properties –Cryogenic fluids and their properties.	<b>4</b>
<b>1.21.2</b>	Applications of Cryogenics: Applications in space, Food Processing, super conductivity, Electrical Power, Biology, Medicine, Electronics and Cutting Tool Industry. Low temperature properties of engineering materials	<b>3</b>
<b>2</b>	<b>Module 2</b>	
<b>2.1</b>	Liquefaction systems ideal system, Joule Thomson expansion, Adiabatic expansion, Linde - Hampson Cycle, Claude & Cascaded System, Magnetic Cooling, Stirling Cycle Cryo Coolers.	<b>4</b>
<b>1.22.2</b>	Gas liquefaction systems: Introduction-Production of low temperatures-General Liquefaction systems- Liquefaction systems for Neon. Hydrogen and Helium – Critical components of Liquefaction systems	<b>4</b>
<b>3</b>	<b>Module 3</b>	
<b>3.1</b>	Cryogenic Refrigeration systems: Ideal Refrigeration systems- Refrigeration using liquids and gases as refrigerant- Refrigerators using solids as working media	<b>4</b>

1.23.2	Gas separation and purification: Thermodynamic ideal separation system, mixture characteristics, principle of gas separation, separation of air, hydrogen and helium, gas purification methods	3
4	<b>Module 4</b>	
4.1	Cryogenic fluid storage and transfer systems: Cryogenic Storage vessels and Transportation, Thermal insulation and their performance at cryogenic temperatures, Super Insulations, Vacuum insulation, Powder insulation, Cryogenic fluid transfer systems, Cryo pumping.	7
5	<b>Module 5</b>	
5.1	Cryogenic instrumentation, Pressure flow-level and temperature measurements, Types of heat exchangers used in cryogenic systems, Safety in cryogenic fluid handling, storage and use.	7

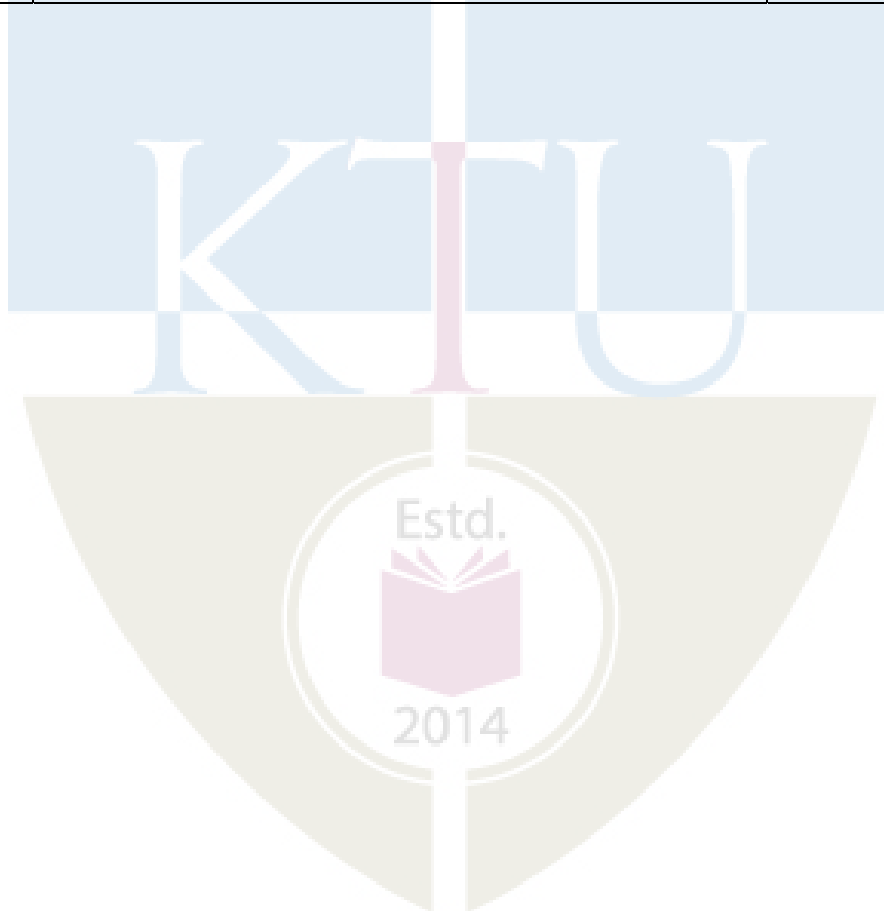

APJ ABDUL KALAM  
TECHNOLOGICAL  
UNIVERSITY

**SEMESTER VIII**

**PROGRAM ELECTIVE V**



CODE	COURSE NAME	CATEGORY	L	T	P	CREDIT
MET418	RELIABILITY ENGINEERING	PEC	2	1	0	3

**Preamble:**

1. To induce in students an attitude towards reliability which will ensure that they lookout for steps to avoid failures to achieve success in all assignments they take up. That will help them become true engineers.
2. To generate in students an awareness of the importance of statistical concepts, and to make them realise that engineering is also largely statistics based.

**Prerequisite:** MAT 202 Probability, Statistics and Numerical Methods

**Course Outcomes:** After the completion of the course the student will be able to:

CO 1	Explain the basic concepts of reliability, various models of reliability and failure concepts.
CO 2	Analyse mathematical models of reliability and failure modes.
CO 3	Perform the design process of reliability.
CO 4	Explain the relation between reliability, availability and maintainability.
CO 5	Explain economic aspects of reliability and Perform reliability management effectively.

**Mapping of course outcomes with program outcomes**

	PO 1	PO 2	PO 3	PO 4	PO 5	PO 6	PO 7	PO 8	PO 9	PO 10	PO 11	PO 12
CO 1	2	2	2	2	1							
CO 2	2	3	2	2	2							
CO 3	3	2	1	2	1						2	
CO 4	3	1	3	1	1	1						
CO 5	2	2	1	2	3	1					2	

**Assessment Pattern**

Bloom's Category	Continuous Assessment Tests		End Semester Examination
	1	2	
Remember	10	10	10
Understand	20	20	20
Apply	20	20	70
Analyse			
Evaluate			
Create			

**Mark distribution**

Total Marks	CIE	ESE	ESE Duration
150	50	100	3 hours

**Continuous Internal Evaluation Pattern:**

Attendance	: 10 marks
Continuous Assessment Test (2 numbers)	: 25 marks
Assignment/Quiz/Course project	: 15 marks

**End Semester Examination Pattern:** There will be two parts; Part A and Part B. Part A contain 10 questions with 2 questions from each module, having 3 marks for each question. Students should answer all questions. Part B contains 2 questions from each module of which student should answer any one. Each question can have maximum 2 sub-divisions and carry 14 marks.

**Course Level Assessment Questions****Course Outcome 1 (CO1):**

1. Define the term reliability? Explain the reliability function.
2. Relate Reliability and Quality.
3. What is component failure and system failure?
4. Explain Weibull distribution and Normal distribution.

**Course Outcome 2 (CO2)**

1. Describe Weakest-link Technique.

2. Explain various mathematical models of reliability.
3. Explain Redundancy optimization.
4. Explain load sharing systems and standby system.

**Course Outcome 3 (CO3):**

1. How quality and reliability is related?
2. Explain System safety and Fault Tree Analysis.
3. What is Tie-set and Cut-set methods?
4. Explain the use of Boolean Algebra in reliability analysis.

**Course Outcome 4 (CO4):**

1. Describe repair time distribution in maintainability.
2. What is relationship between reliability and availability?
3. What is achieved availability and operational availability?
4. Explain Markovian models?

**Course Outcome 5 (CO5):**

1. What are the costs considered in reliability engineering?
2. Describe reliability achievement cost model?
3. Explain reliability utility cost model.
4. What are the functions of reliability management groups?



**Model Question Paper**

**APJ ABDUL KALAM TECHNOLOGICAL UNIVERSITY  
VIII SEMESTER BTECH DEGREE EXAMINATION  
MET418: RELIABILITY ENGINEERING**

**Maximum:100 Marks****Duration:3 hours****PART A***Answer all questions, each question carries 3 marks*

1. Define the term reliability? Explain the reliability function.
2. Explain the term MTTF. Also derive it with respect to reliability and CDF.
3. State k-out-of-m system redundancy?
4. What is mixed redundancy?
5. Explain the static model for constant strength and load?
6. What is a tie and cut set?
7. Explain inherent availability?
8. What is MTBF?
9. Discuss the economic issues of reliability.
10. Draw and explain reliability-cost curves of a product.

**PART B****Answer one full question from each module****MODULE 1**

11. a) Draw and explain Bath tub Curve. (4)  
 b) The time to wear for a cutting tool is distributed normally with a mean of 2.8 hour and standard deviation of 0.6 hour. Find  
 I. The probability that the tool will wear out in 1.5 hours  
 II. Find out the reliability for 1.5 hours  
 III. How often the cutting edge of the tool must be replaced in order to keep the failure less than 10 percentage? (10)
12. a) Find out the system reliability for a serial and parallel configuration with 2 components. (7)

- b) Find out the reliability of the following system with 1,2,3,4,5 and 6 as 0.85,0.90, 0.95,0.90,0.80 and 0.85 respectively. Find out the tie sets and cut sets (7)

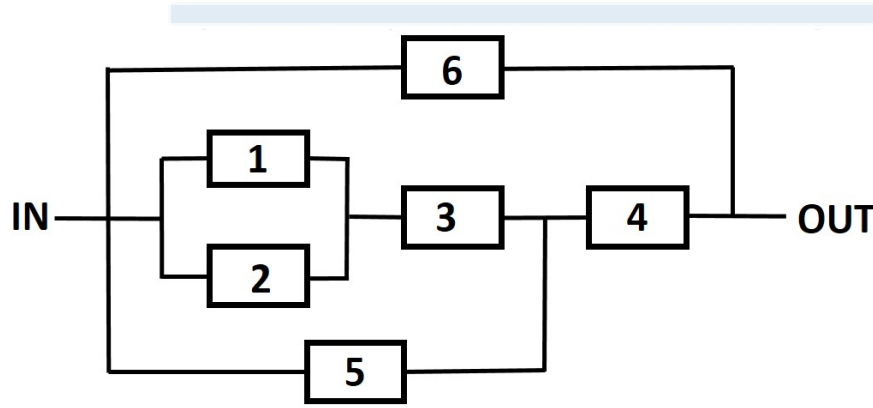

## MODULE 2

13. a) Compare unit vs Component Redundancy with sketches (6)

b) Given a budget of Rs 700 and the following data on three components that must operate in series. Determine, using marginal analysis, the optimum number of redundant units. Compute the achieved reliability. (8)

Components	Reliability	Unit Cost (In rupees)
1	0.80	200
2	0.90	100
3	0.95	75

14. a) Find out the reliability using markov analysis for load sharing units? (6)

b) A manufacturing company operates two production lines when both lines are operating, the production rate on each line is 500 units per hour. At this production rate the failure rate of line 1 is 3 failures per 8-hr day (CFR) and the failure rate of line 2 is 2 failures per 8-hr day. When one line fails, the production rate of the second line must be increased in order to make production quotas. At the increased rate of 800 units per hour, the failure rate of line 1 is 6 per 8 hr day and the failure rate of line is 3 per 8-hr day. Find the reliability and the MTTF and the reliability of the production system over a 1 hr and over an 8 hr production run. (8)

**MODULE 3**

15. a) With a block diagram explain the reliability design process. (5)

b) A system consists of three components in series having the following parameters. The reliability goal is 0.90 for the system. Do the reliability allocation. (9)

Components	Reliability	Unit Cost (In rupees)
1	0.85	25
2	0.80	20
3	0.90	40

16.a) Explain the steps in FMECA. (6)

b) In the context of fault tree analysis, explain the meaning of each of the following: an 'AND' gate, an 'OR' gate, a priority 'AND' gate, 'top' event, a 'basic' event, an 'undeveloped' event. In each of the case, sketch the conversional symbol used and give a practical example. (8)

**MODULE 4**

17. a) Compute markov analysis of availability model for two component stand by system. (6)

b) A generator system consist of primary and a standby unit. The primary fails at a constant rate of 2 per month, and the stand by system fails only when online at a constant rate of 4 per month. Repair can begin only when both units have failed. Both units are repaired at the same time with an MTTR of 20 days. Derive the steady state equations for the state probabilities and solve for the system availability. (8)

18. a) What is inspection and repair availability model? Explain a case for it. (6)

b) Determine the upper bound for each of the following aircraft subsystems MTTRs if a system availability goal of 0.95 is desired. Assume the repair restores the subsystem to as good as new and each system has the same availability. (8)

Subsystem	Time Between failures	Parameters
Propulsion	Weibull	$\theta = 1000, \beta = 1.7$
Avionics	Exponential	$\lambda = 0.003$
Structures	Weibull	$\theta = 2000, \beta = 2.1$
Electrical	Weibull	$\theta = 870, \beta = 1.8$
Environmental	Exponential	$\lambda = 0.001$

**MODULE 5**

19. Explain reliability achievement cost model (7)
20. Explain Reliability management by objectives (7)

**SYLLABUS****Module – I**

Reliability concepts: Definition of reliability, Reliability vs. Quality, Reliability function, MTTF, hazard rate function, bathtub curve, derivation of the reliability function, Failure and Failure modes, Causes of Failures and Unreliability. Reliability Models: constant failure rate model, time dependent failure models. Weibull distribution, Normal distribution, log normal distribution. Serial configuration, parallel configuration, combined series parallel systems, K-out-of-m systems.

**Module – II**

Redundancy Techniques in System design: Component vs Unit redundancy, Weakest-link Technique, Mixed redundancy, Standby redundancy, Redundancy optimization, Double failures and Redundancy. Markov analysis, load sharing systems, standby system, degraded systems, three state devices, covariate models.

**Module – III**

Reliability design process, system effectiveness, economic analysis and life cycle cost, Reliability allocation, optimal allocations, ARINC, AGREE methods. System safety and Fault Tree Analysis, Tie-set and Cut-set methods, Use of Boolean Algebra in reliability analysis.

**Module – IV**

Maintainability and Availability: Definitions and basic concepts, Relationship between reliability, availability and maintainability, Inherent availability, Achieved availability, Operational availability, Repairable systems, Markovian models. Reliability Allocation: for series system.

**Module – V**

Economics of Reliability: Economic issues, Manufacturers cost, Customers cost, reliability achievement cost models, reliability utility cost models, depreciation cost models, availability cost model for parallel systems. Reliability management, Reliability management by objectives

**Text books:**

1. Balagurusamy E., *Reliability Engineering*, Tata McGraw Hill.
2. Srinath L. S., *Reliability Engineering*, East West Press.
3. Charles E. Ebeling, *Reliability and Maintainability Engineering*, Tata McGraw Hill.
4. Patrick D. T. O'Connor, *Practical Reliability Engineering*, John

**Reference Books:**

1. E.E. Lewis, *Introduction to Reliability Engineering*, JW.
2. NVR Naidu, et al, *Total Quality Management*, New Age International Publishers.
3. J.M. Juran and Frank M. Gryna, *Quality Planning and Analysis*, Tata McGraw Hill.

**Course Contents and Lecture Schedule:**

No	Topic	No. of Lectures
1.1	Definition of reliability, Reliability vs. Quality, Reliability function, MTTF, hazard rate function, bathtub curve, derivation of the reliability function	2
1.2	Failure and Failure modes, Causes of Failures and Unreliability	2
1.3	Reliability Models: constant failure rate model, time dependent failure models.	1
1.4	Weibull distribution, Normal distribution, lognormal distribution.	1
1.5	Serial configuration, parallel configuration, combined series parallel systems, K-out-of-m systems.	1
2.1	Redundancy Techniques in System design: Component vs Unit redundancy, Weakest-link Technique,	3
2.2	Mixed redundancy, Standby redundancy, Redundancy optimization Double failures and Redundancy.	3
2.3	Markov analysis, load sharing systems, standby system	1
3.1	Reliability design process, system effectiveness, economic analysis and life cycle cost	2
3.2	Reliability allocation, optimal allocations	1
3.3	ARINC, AGREE methods	1
3.4	System safety and Fault Tree Analysis, Tie-set and Cut-set methods	2
3.5	Use of Boolean Algebra in reliability analysis.	1
4.1	Maintainability and Availability: Definitions and basic concepts, Relationship between reliability, availability and maintainability	3

4.2	Inherent availability, Achieved availability, Operational availability	2
4.3	Operational availability, Repairable systems, Markovian models	2
4.4	Reliability Allocation: for series system.	1
5.1	Economics of Reliability: Economic issues, Manufacturers cost, Customers cost, reliability achievement cost models	3
5.2	reliability utility cost models, depreciation cost models, availability cost model for parallel systems	3
5.3	Reliability management, Reliability management by objectives	1

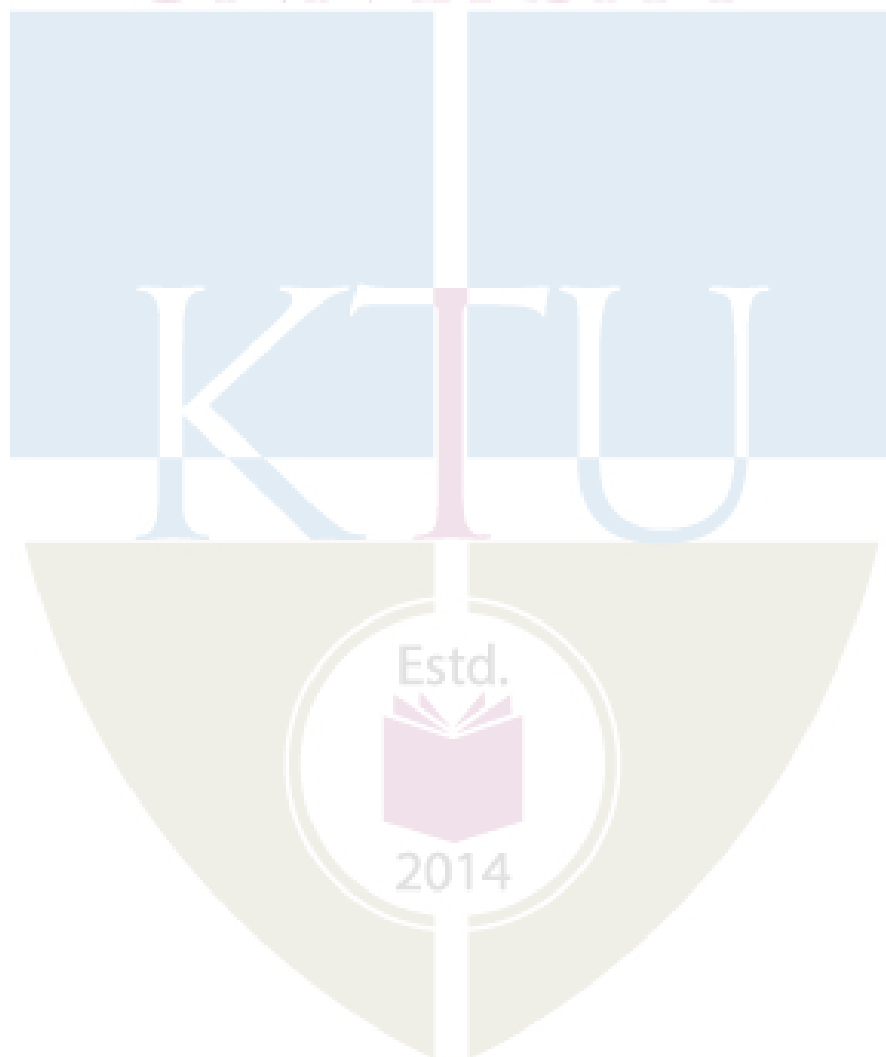

CODE	COURSE NAME	CATEGORY	L	T	P	CREDIT
MET428	PROJECT PLANNING AND MANAGEMENT	PEC	2	1	0	3

**Preamble:** This course involves the application of principles studied in Project planning, Analysis, Selection Implementation of different project which has social cost, multiple projects, project review, financial analysis. This course also covers the financials of projects, improving and evaluating review the performance of the project. This course also helps to understand the risk analysis and capital budgeting and working capital management.

**Prerequisite:** Nil

**Course Outcomes:** After the completion of the course the student will be able to

CO 1	Overview about the Capital investment, Strategy, Generation & Screening of Project Idea, Demand analysis.
CO 2	Discuss the Technical Analysis, Product Mix, Plant Capacity, Cost of project and means finance. Cash flow, Projected Balance sheet, Trial balance, Profit and Loss account, Time value of money.
CO 3	Discus about the investment analysis, Cash flow of the project, Cost of capital, Project Risk, Multiple projects, Social Cost Benefit Analysis, Capital Budgeting.
CO 4	Rate return of projects, Project financing, Financing infrastructure projects, Financial Institutions, Working capital management. Term loan appraisal.
CO 5	Discuss the principles of Project Management, PERT, CPM, Project overview, Post audit, Critical path.

#### Mapping of course outcomes with program outcomes

	PO 1	PO 2	PO 3	PO 4	PO 5	PO 6	PO 7	PO 8	PO 9	PO 10	PO 11	PO 12
CO 1	3	2	2									
CO 2	2	2	3									
CO 3	3	2	2									
CO 4	3	2	2								2	
CO 5	2	2	3									

#### Assessment Pattern

Bloom's Category	Continuous Assessment Tests		End Semester Examination
	1	2	
Remember	10	10	10
Understand	20	20	20
Apply	20	20	70
Analyse			
Evaluate			
Create			

**Mark distribution**

<b>Total Marks</b>	<b>CIE</b>	<b>ESE</b>	<b>ESE Duration</b>
150	50	100	3 hours

**Continuous Internal Evaluation Pattern:**

Attendance	: 10 marks
Continuous Assessment Test (2 numbers)	: 25 marks
Assignment/Quiz/Course project	: 15 marks

**End Semester Examination Pattern:** There will be two parts; Part A and Part B. Part A contain 10 questions with 2 questions from each module, having 3 marks for each question. Students should answer all questions. Part B contains 2 questions from each module of which student should answer any one. Each question can have maximum 2 sub-divisions and carry 14 marks.

**Course Level Assessment Questions****Course Outcome 1 (CO1):**

1. Types of capital investments and phases of capital budgeting. The detailed explanations of project analysis and key issues in major investment decisions.
2. Explain the grand strategy and diversification debates and SPACE.
3. What is positive NPV (net present value), explain tools for identifying investment opportunity.

**Course Outcome 2 (CO2):**

1. What is the industry specific source of secondary information and characteristics of market? Demand forecasting and trend projection.
2. What are the sources of uncertainties in demand? Describes the aspects covered in market planning.
3. Explain Plant capacity, Product mix, Location and Site? Describe the important charts and layout drawings.
4. Discuss the importance of Balance sheet and cash flow statement. Explain the means of finance.

**Course Outcome 3(CO3):**

1. What is an annuity? State the formula for the present value of an annuity?
2. What is NPV, IRR, Payback period? Explain the properties of the NPV rule?
3. Explain the principles of cash flow estimation? explain WACC and technics for risk analysis.

**Course Outcome 4 (CO4):**

1. Explain the portfolio theory and capital budgeting. Explain why the firms set a hurdle rate higher than the WACC.
2. How the economic life of a project determined? What is NPV and how is it calculate ?
3. Explain the public sector investment decision in India? Explain working capital management and project financing.
4. Explain capital structure? Explain key factors in determining the Debt- Equity ratio?

**Course Outcome 5 (CO5):**

1. Describe the PPP and its advantage and disadvantage.
2. Describe the tools of project planning and explain how the performance is analysed?
3. What are the pre-requisites for successful project implementation, explain?
4. What is essence of Project Management? Describe the notion of hierarchy of plans?
5. Explain network techniques and time estimations? Explain PERT and CPM.

**Model Question Paper**

**APJ ABDUL KALAM TECHNOLOGICAL UNIVERSITY**

**VIII SEMESTER BTECH DEGREE EXAMINATION**

**MET428 : PROJECT PLANNING & MANAGEMENT**

Maximum: 100 Marks

Duration:3 hours

**PART A**

Answer all questions, each question carries 3 marks

1. Explain Types of Capital Investments.
2. Explain the preliminary screening of project ideas.
3. What are the uncertainties in demand forecasting?
4. What are the factors influenced by the selection of Technology?
5. Explain Cash flow and cost of capital of a project?
6. Explain the procedure of Morse test.
7. Discuss about benefit cost ratio and IRR.
8. Explain sources, Measures and Perspectives on Risk?
9. Discus the key factors in determining the Debt-Equity Ratio.
10. Define Network techniques for project management. Explain PERT and CPM.

(10×3=30 Marks)

**PART B****Answer one full question from each module****MODULE 1**

11. a) Explain the phases of Capital budgeting and Common weakness of Capital Budgeting? (8 marks)
- b) Derive the components of Marketing plan and key project inter-linkage? (6 marks)
12. a) Explain strategic planning and capital budgeting? Discuss the various strategies for growth strategy and contraction strategies. (8 marks)
- b) Discuss the source of positive NPV and qualities and traits required for a successful entrepreneur. (6 marks)

**MODULE 2**

13. a) What is information required for preparing the project implementation schedule. Discuss the importance of considering alternative ways of transferring an idea in to a concrete project. (6 marks)
- b) Describe Cost project, Cost of Product and Means of finance ? (8 marks)
14. a) Explain cost of project, means of finance. Discuss contribution of a projected Balance sheet in a project? (6 marks)
- b) Explain Cash flow Statement, Balance sheet, Trail Balance and Profit and Loss account and Time value of Money? (8 marks)

**MODULE 3**

15. a) What are the Investment Criteria? Describe NPV and IRR and properties of the NPV rule. (8 marks)
- b) Discuss the elements of Cash flow stream and basic principles of Cash flow estimation. (6 marks)
16. a) Describe the Sources, Measures and Perspectives on Risk. What are the techniques of Risk analysis and ways and means of mitigating Risk. (8 Marks)
- b) Explain Social cost and benefit differ from monetary costs and benefits. (4 marks)

**MODULE 4**

17. a) Explain the Inventory management and Economic order quantity? (6 marks)
- b) Discuss the PPP and its relevance in India. Explain how financial institutions appraise a project.? (8 marks)
18. a) Explain the Working Capital Management? Discuss components of Credit policy and Impact of credit policy. (8 marks)
- b) Discuss the Cash flow process and its relevance. (6 marks)

## MODULE 5

19. a) Explain PERT and CPM? Discus the rules for the construction of Network Diagram? (6 marks)
- b) Why post audit be done? What is the advantage of conducting performance review? (4 marks)
- c) Explain the difference between Economic rate of return and Book return on Investment? (4 marks)
20. A project consisting of 12 activities and their time activities are shown

Activity.	Time (in weeks)		
	to	tm	tp
1-2	4	6	9
1-3	3	8	12
1-4	5	5	8
1-7	2	4	6
2-4	6	10	18
2-6	3	4	7
2-7	5	10	16
3-4	3	6	11
4-5	2	4	6
5-6	1	3	7
3-7	2	4	8
6-7	1	2	6

- a) Draw the Network diagram. (3 marks)
- b) Determine the Critical path. (3 marks)
- c) Calculate event slacks and activity floats. (3 marks)
- d) Find the standard Deviation of the critical path duration? (3 marks)
- e) Compute the probability of completing the project in 30 weeks. (2 marks)

## Syllabus

### Module 1

Capital Investment – importance and differences, Phases of Capital Budgeting, Decision making, Project analysis- Risks, Discounted cash flow (DCF), Financing, Earning per share (EPS), weakness in capital budgeting, Formulation of strategies, grand strategy, Diversification-risk reduction- value creation, portfolio strategy, business level strategies, screening of project idea, tools for identifying investment analysis, preliminary screening, positive net present value, demand forecasting, marketing plan, marketing survey. Demand analysis.

### Module 2

Manufacturing process/ technology, raw materials, product mix, plant capacity, location and site, plant and machinery, project chart and layout, project implementation, need for alternatives, project inter linkage, cost of project, means of finance, profitability projection, basic acceptance and principles of cash flow statement, projected balance sheet, trial balance, profit and loss account, time value of money.

### Module 3

Various investment criteria, net present value (NPV), benefit cost ratio (BCR), internal rate of return (IRR), pay back period, accounting rate of return, project cash flow – basic principle, biases in cash flow estimation, difference between company cost of capital and project cost of capital, project risk analysis, sources,-measures and perspective risk, break even analysis, scenario analysis, managing risk, social cost benefit analysis, UNIDO approach, features of capital budgeting, NPV-IRR comparison, multiple project and constrains.

### Module 4

Project financing, capital structure, key factors in determining the Debt-Equity ratio, sources of finances, equity capital, preference capital, term loan, working capital, project financing structure, financial closure, financial institutions, information and documents for term loan appraisal, project appraisal, credit risk rating, private public partnership (PPP) managing risk in private infrastructure project, working capital management, working capital policy, estimation of working capital, inventory management, purchase, optimum level of inventory, economic order quantity, just in time (JIT). Cash Management, Cash flow process. Term loan appraisal, PPP, Inventory Management, Receivable Management, Cash Management.

### Module 5

Project management, principle- forms of project organisation, project planning, project control, authority, orientation, motivation, group function, pre-requisite for successful project implementation, accounts receivable, impact of credit policy, components of credit policy, cash management, motives for holding cash, cash flow process and its relevance, principles of cash management, collection and disbursement management, cash forecasting, network techniques in project management, development of project network, rules for network construction, time estimation, determination of critical path, schedule when resources are limited, Network Technologies, PERT model, CPM model, network cost system, project review, post audit, abandonment analysis, overcome resistance, managing divestments, Project review.

**Text Books**

1. Weist, J.D, and F.K. Levy, A management Guide to PERT/CPM, Prectice-Hall of India, New Delhi, 1974.
2. Pouliquen.L.Y, Risk analysis in Project aAprisal, Johns Hopkins Press, Baltimore, California. 1970.
3. Rajiv Srivastava and Anil Misra, Financial Management, Oxford University Press, New Delhi.
4. Dr.Prasanna Chandra. Project Planning, Implementation and Review. Tata McGraw Hill , NewDelhi.

**Reference Books**

1. Amran M and N.Kulatilalka, Managing strategic investment in Uncertian world. HARward Business school press, Boston 2000.
2. Reghuram G Infrastructure development and financing, Macmillon India, Delhi, 1999
3. UNIDO, Guidline for project evaluation, United nations, 1972
4. Weingartner, M.H., Mathematical programming and Analysis of capital budjeting problemes, Prentice-Hall, EnglewoodmCliffs, N.J, 1963.

**Course Contents and Lecture Schedule**

No	Topic	No. of Lectures
1		
1.1	Capital Investment – importance and differences, Phases of Capital Budgeting, Decision making, Project analysis- Risks, Discounted cash flow (DCF), Financing, Earning per share (EPS), weakness in capital budgeting, Formulation of strategies, grand strategy,	3
1.2	Diversification-risk reduction- value creation, portfolio strategy, business level strategies, screening of project idea, tools for identifying investment analysis,	2
1.3	preliminary screening, positive net present value, demand forecasting, marketing plan, marketing survey, Demand analysis.	2
2		
2.1	Manufacturing process/ technology, raw materials, product mix, plant capacity, location and site, plant and machinery, project chart and layout, project implementation, need for alternatives, project inter linkage,	2
2.2	Cost of project, means of finance, profitability projection, basic acceptance and principle of cash flow statement, time value of money.	2

2.3	Projected balance sheet, trial balance, profit and loss account,	3
3		
3.1	Various investment criteria, net present value (NPV), benefit cost ratio (BCR), internal rate of return (IRR), payback period, accounting rate of return, project cash flow – basic principle, biases in cash flow estimation	3
3.2	Difference between cost of capital and project cost of capital, project risk analysis, sources, -measures and perspective risk, break even analysis, scenario analysis, managing risk.	2
3.3	social cost benefit analysis, UNIDO approach, features of capital budgeting, NPV-IRR comparison, multiple projects and constrains	2
4		
4.1	Project financing, capital structure, key factors in determining the Debt-Equity ration, sources of finances, equity capital, preference capital, term loan, working capital, project financing structure, financial closure, financial institutions,	3
4.2	information and documents for term loan appraisal, project appraisal, credit risk rating, private public partnership (PPP)managing risk in private infrastructure project, working capital management, working capital policy, estimation of working capital, Term loan appraisal, PPP.	2
4.3	Inventory management, purchase, optimum level of inventory, economic order quantity, just in time (JIT). Cash Management, cash flow process, Cash management.	2
5		
5.1	Project management, principle- forms of project organisation, project planning, project control, authority, orientation, motivation, group function, pre-requisite for successful project implementation	2
5.2	Accounts receivable, impact of credit policy, components of credit policy, cash management, motives for holding cash, cash flow process and its relevance, principles of cash management, collection and disbursement management, cash forecasting,	2
5.3	Network techniques in project management, development of project network, rules for network construction, time estimation, determination of critical path, schedule when resources are limited, PERT model, CPM model, network cost system, project review, post audit, abandonment analysis, overcome resistance, managing divestments, decision making, Project review.	3



**Assessment Pattern**

Bloom's Category	Continuous Assessment Tests		End Semester Examination
	1	2	
Remember			
Understand	30	30	30
Apply	20	20	70
Analyse			
Evaluate			
Create			

**Mark distribution**

Total Marks	CIE	ESE	ESE Duration
150	50	100	3 hours

**Continuous Internal Evaluation Pattern:**

Attendance	: 10 marks
Continuous Assessment Test (2 numbers)	: 25 marks
Assignment/Quiz/Course project	: 15 marks

**End Semester Examination Pattern:** There will be two parts; Part A and Part B. Part A contain 10 questions with 2 questions from each module, having 3 marks for each question. Students should answer all questions. Part B contains 2 questions from each module of which student should answer any one. Each question can have maximum 2 sub-divisions and carry 14 marks.

**Course Level Assessment Questions****Course Outcome 1 (CO1):**

1. Describe the historical perspective of fracture and failure studies.
2. Explain the different modes of fracture failure.
3. Explain damage tolerance approach in design.

**Course Outcome 2 (CO2)**

1. Explain the concept of crack propagation based on energy release rate and surface energy.
2. Explain change in compliance approach and change in strain energy approach in crack propagation study.
3. Explain the difference between stable and unstable crack growth using R curve.

**Course Outcome 3(CO3):**

1. Explain the advantages of Stress Intensity factor over Energy release rate in fracture studies.
2. Solve simple problems using stress Intensity factor equations for mode 1, mode 2 and mode 3 type fracture failure.
3. Derive the stress Intensity factor equations for mode 1, mode 2 and mode 3 type fracture failure.

**Course Outcome 4 (CO4):**

1. Explain the plastic zone shape for plane stress and plane strain using a neat figure
2. Explain Irwin's correction for determining plastic zone size.
3. Explain Dugdale approach to find the size of the crack tip plastic zone.

**Course Outcome 5 (CO5):**

1. Explain the conditions for rapid crack propagation and crack arrest
2. Explain Paris Law and crack closure.
3. Explain the different causes of corrosion

**Model Question Paper****Maximum: 100 Marks****Duration: 3 hours****MET438 FRACTURE MECHANICS****Answer all questions. Each question carries 3 marks****(10 X 3 = 30 Marks)**

1. List any six causes of mechanical failure.
2. Differentiate between brittle and ductile fracture.
3. Define Griffith's theory.
4. Explain Surface energy of a solid.
5. Explain Stress Intensity Factor.
6. What is a singularity? What kind of singularity describes a stress field near the vicinity of a crack tip in LEFM?
7. In comparison to a plane strain case, a plane stress loading gives much larger plastic zone for the same SIF? Why?
8. Explain the term 'effective crack length'.
9. Explain the effect of an overload pulse inside a constant amplitude fatigue load on crack propagation.
10. Why does the environment-assisted cracking occur mostly through inter-granular growth?

**PART B****Answer one question from each module****MODULE 1**

11. Explain with neat sketch the different modes of fracture failure.

**OR**

12. Discuss the historic overview of Fracture Mechanics.

**MODULE 2**

13. Derive the equation to find the energy release rate,  $G$  of a double cantilever beam (DCB), subjected to (i) constant load  $P$  and (ii) constant displacement.

**OR**

14. Explain the conditions for stable and unstable crack growth in a ductile material using R curve

## MODULE 3

15. For a centre crack in an infinite plate loaded in Mode II, determine stress components and displacement components (plane stress) near the vicinity of a crack tip in terms of  $K_{II}$ .

OR

16. In a large plate, a crack of length  $2a$  is inclined with an angle  $\alpha$  with  $x_1$ -axis as shown in figure. The plate is loaded in  $x_2$  direction with  $\sigma_{22} = \sigma$ . (i) Find the stress intensity factors. (ii) For  $\sigma = 80$  MPa,  $2a = 20$  mm and  $\alpha = 30^\circ$ , determine  $K_I$  and  $K_{II}$ .

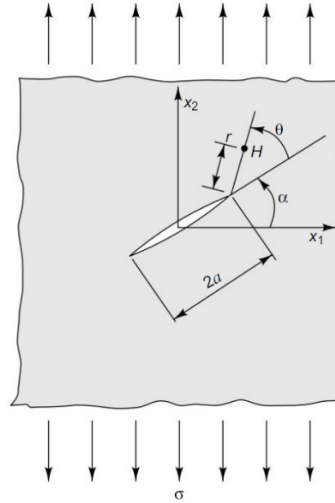

## MODULE 4

17. Explain with neat sketch, the plastic zone shape for plane stress condition.

OR

18. A large plate of 5 mm thickness, made of medium carbon steel ( $\sigma_{ys} = 350$  MPa) with a through-the-thickness centre-crack of  $2a = 40$  mm length, is subjected to a stress of 150 MPa. For Mode I loading, determine the effective crack length using Irwin's correction.

## MODULE 5

19. What do you mean by crack closure? What are the factors affecting crack closure? Explain its effects on crack propagation.

OR

20. Explain the major factors influencing environment-assisted fracture.

## Syllabus

### Module 1

Introduction to fracture mechanics: - Review on conventional design methodologies, Brittle and ductile fracture, Modes of fracture failure, Damage tolerance, Spectacular failures, Lessons from spectacular failures, fracture mechanics approach to design, damage tolerance approach to design (review).

### Module 2

Griffith's Dilemma – surface energy- Griffith analysis – Energy Release Rate – Double cantilever beam (DCB) with constant load, DCB with fixed grip, Energy release rate of DCB specimen.

Anelastic deformation at crack-tip, Crack resistance, stable and unstable crack growth, R-curve, Critical energy release rate (concepts only).

### Module 3

Linear Elastic Fracture Mechanics (LEFM): - stress and displacement fields in isotropic elastic materials - Stress intensity factor - Field equations - Airy's Stress Function - Biharmonic Equation, Westergaard's Approach (concepts only, no derivations, final result).

### Module 4

Anelastic Plastic Zone Shape and Size: - plastic zone shape for plane stress - plastic zone shape for plane strain. Effective Crack Length: - approximate approach - Irwin's correction – Dugdale approach.

### Module 5

J - Integral: Path independence of J - integral (concepts only), stress strain relation, Engineer approach to J – integral, Ramberg - Osgood relation (simple problem only). Fatigue Crack Propagation: - Paris Law – crack closure. Environmentally Assisted Cracking: - types of corrosion – cracking mechanism. Corrosion Fatigue (concepts only).

### Text Books

1. Prashant Kumar, Elements of Fracture Mechanics, Tata McGraw Hill, New Delhi, India, 2009

### Reference Books

1. T.L. Anderson, Fracture Mechanics – Fundamentals and Applications, 3rd Edition, Taylor and Francis Group, 2005.

2. K. Ramesh, e-Book on Engineering Fracture Mechanics, IIT Madras, 2007. URL: [http://apm.iitm.ac.in/smlab/kramesh/book\\_4.htm](http://apm.iitm.ac.in/smlab/kramesh/book_4.htm)

3. K. R.Y. Simha, Fracture Mechanics for Modern Engineering Design, Universities Press (India) Limited, 2001
4. Kare Hellan, “Introduction of Fracture Mechanics”, McGraw-Hill Book Company, 1985.
5. David Broek, “Elementary Engineering Fracture Mechanics”, Fifth off and Noerdhoff International Publisher, 1978.
6. Kachanov.L.M., “Foundations of Theory of Plasticity”, North-Holland Publishing Co., 1971.

### Course Contents and Lecture Schedule

No	Topic	No. of Lectures
<b>1</b>	<b>Module-1</b>	<b>6 Hr</b>
1.1	Introduction to fracture mechanics: - Review on conventional design methodologies	1
1.2	Brittle and ductile fracture, Modes of fracture failure	1
1.3	Damage tolerance, Spectacular failures	1
1.4	,Lessons from spectacular failures,	1
1.5	fracture mechanics approach to design	1
1.6	Damage tolerance approach to design (review).	1
<b>2</b>	<b>Module-2</b>	<b>7 Hr</b>
2.1	Griffith’s Dilemma – surface energy-	1
2.2	Griffith analysis – Energy Release Rate –	1
2.3	Double cantilever beam (DCB) with constant load, DCB with fixed grip,	1
2.4	Energy release rate of DCB specimen	1
2.5	Anelastic deformation at crack-tip, R-curve,	1
2.6	Crack resistance, stable and unstable crack growth,	1
2.7	R-curve, Critical energy release rate (concepts only).	1
<b>3</b>	<b>Module-3</b>	<b>8 Hr</b>
3.1	Linear Elastic Fracture Mechanics (LEFM):	2
3.2	- stress and displacement fields in isotropic elastic materials - -,	1
3.3	Stress intensity factor - Field equations - Airy's Stress Function	2
	Biharmonic Equation	1
3.4	Westergaard’s Approach (concepts only, no derivations, final result)	2
<b>4</b>	<b>Module-4</b>	<b>8 Hr</b>
4.1	Anelastic Plastic Zone Shape and Size:	2
4.2	plastic zone shape for plane stress	1
4.3	Effective Crack Length: - approximate approach	1

4.4	plastic zone shape for plane strain.	2
4.5	Irwin's correction	1
4.6	Dugdale approach	1
<b>5</b>	<b>Module-5</b>	<b>8 Hr</b>
5.1	J - Integral: Path independence of J - integral (concepts only)	1
5.2	Stress strain relation	1
5.3	Engineer approach to J – integral	1
5.4	Ramberg - Osgood relation (simple problem only)	1
5.5	Paris Law – crack closure. Environmentally Assisted Cracking	2
5.6	Types of corrosion – cracking mechanism. Corrosion Fatigue (concepts onl	2

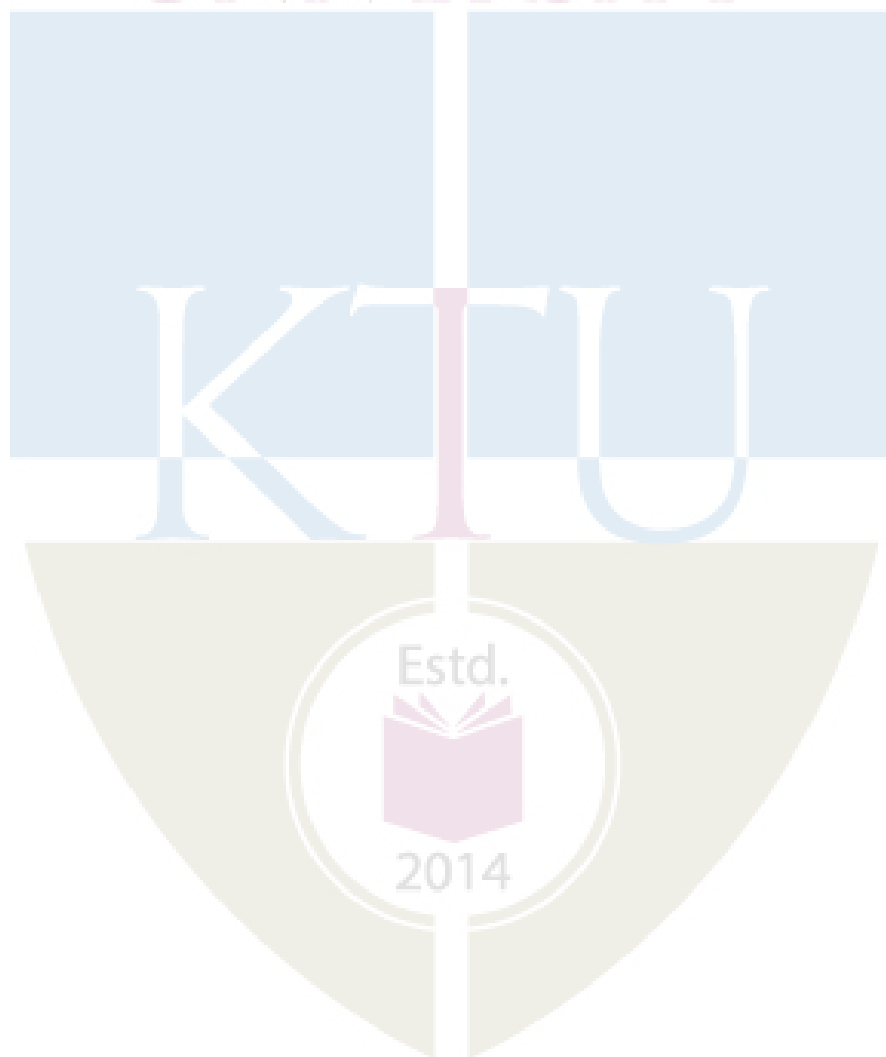



**Assessment Pattern**

Bloom's Category	Continuous Assessment			End Semester Examination
	Assignment (%)	Test 1 (%)	Test 2 (%)	
Remember	25	20	20	10
Understand	25	40	40	20
Apply	25	40	40	70
Analyse	25			
Evaluate				
Create				

**Mark distribution**

Total Marks	CIE	ESE	ESE Duration
150	50	100	3 hours

**Continuous Internal Evaluation Pattern:**

Attendance	: 10 marks
Continuous Assessment Test (2 numbers)	: 25 marks
Assignment/Quiz/Course project	: 15 marks

**End Semester Examination Pattern:** There will be two parts; Part A and Part B. Part A contain 10 questions with 2 questions from each module, having 3 marks for each question. Students should answer all questions. Part B contains 2 questions from each module of which student should answer any one. Each question can have maximum 2 sub-divisions and carry 14 marks.

**Course Level Assessment Questions****Course Outcome 1 (CO1):**

1. Represent Brayton cycle in PV and TS coordinates.
2. Define closed cycle and semi closed cycle gas turbines

**Course Outcome 2 (CO2)**

1. Discuss laws pertaining to Gas Turbines
2. Discuss laws pertaining to Jet Propulsion

**Course Outcome 3 (CO3):**

1. Discuss problems related to Gas Turbines
2. Discuss problems related to Jet Propulsion

**Course Outcome 4 (CO4):**

1. Discuss about the solutions related to Gas Turbine problems
2. Discuss about the solutions related to Jet Propulsion problems

**Course Outcome 5 (CO5):**

1. Discuss about the applications in the field

**Course Outcome 6 (CO6):**

1. Discuss about different techniques in rocket propulsion

**Model Question Paper**

**APJ ABDUL KALAM TECHNOLOGICAL UNIVERSITY**

**GAS TURBINES AND JET PROPULSION -MET448**

**Maximum: 100 Marks**

**Duration: 3 hours**

**PART A**

**Answer all questions. Each question carries 3 marks**

**(10 X 3 = 30 Marks)**

1. What are the applications of gas turbines?
2. List the advantages of closed cycle gas turbine system over open cycle system.
3. What are the different methods used to improve the efficiency of gas turbine
4. Explain the significance of intercooler. What is meant by perfect intercooling?
5. Why are propeller engines not commonly used nowadays in aircrafts?
6. State the difference between air breathing and non-air breathing propulsion
7. Define thrust power and propulsive power.
8. What is propellant? How are propellants classified?

9. Explain about free radical propulsion.
10. What is meant by thrust and its limiting factors?

## PART B

### Answer one question from each module

#### MODULE 1

11. An air nozzle is to be designed for an exit Mach number of 2. conditions of the air available in the reservoir are 700 kPa, 533 K. Estimate i) pressure ii) temperature iii) velocity of flow iv) area, at throat and exit of the nozzle. Mass flow rate through the nozzle is 10000 kg/hr.

14 marks

12..Derive the conservation of mass equation for compressible flow through control volume approach.

14 marks

#### MODULE II

13. Explain constant pressure and constant volume gas turbines with diagrams

14 marks

14. Explain intercooling, reheating and their combinations

14 marks

#### MODULE III

15. Explain the operation of single stage reciprocating compressor

14 marks

16. Explain centrifugal compressors and axial flow compressors

14 marks

#### MODULE IV

17. Explain factors affecting combustion chamber design

14 marks

18.Explain gas turbine combustion chamber performance

14 marks

#### MODULE V

19. Explain air breathing propulsion system

14 marks

20. Explain rocket propulsion system

14 marks

Note: Problems also can be asked from module 2 and 3. Each question can have maximum two sub divisions

## Syllabus

**Module 1- Compressible Flow:** Wave propagation and sound velocity; Mach number and compressible flow regimes; basic equations for one-dimensional compressible flow, isentropic flow relations; area-velocity relation; normal shock waves, relation between upstream and downstream flow parameters.

**Module 2- Gas Turbine Systems and Cycles:** System of operation of gas turbines-constant volume and constant pressure gas turbines; thermodynamics of Brayton cycle; regeneration-inter-cooling, reheating and their combinations; closed cycle and semi-closed cycle gas turbines; Compare Gas turbines, I.C engines and steam turbines.

**Module 3- Compressors:** Classification-positive displacement and dynamic compressors, Operation of single stage reciprocating compressors; isothermal efficiency; volumetric efficiency; multi-stage compression. Centrifugal compressors; principle of operation; work done and pressure rise; diffuser; compressibility effects; non dimensional quantities for plotting compressor characteristics; compressor characteristics. Axial flow compressors; basic operation; elementary theory; factors effecting stage pressure ratio; degree of reaction; calculation of stage performance; Axial flow characteristics.

**Module 4- Combustion Systems:** Types, operational requirements; combustion process; factors affecting combustor design; combustion chamber performance; Gas turbine emissions.

**Module 5- Air-breathing Propulsion Systems:** Principle of jet propulsion; analysis and performance characteristics of turbojet, turboprop, ramjet and pulsejet; thrust power and propulsion efficiency. **Rocket Propulsion:** Operating principle; solid and liquid propellants, performance analysis-calculations for specific impulse and propulsive efficiency.

### Text Books

1. Gas Turbine Theory – Saravanamuttoo, Cohen and Rogers, Pearson Education Asia
2. Gas Turbines – V. Ganesan, Tata McGraw Hill

### Reference books

1. Elements of Gas Turbine Propulsion- James Mattingly, Tata McGraw Hill
2. Gas Turbine Engine Technology – Irwin E Treager, McGraw Hill Education, 2013

## Course Contents and Lecture Schedule

MODULE	TOPICS	HOURS ALLOTTED
1	<b>Compressible Flow:</b> Wave propagation and sound velocity; Mach number and compressible flow regimes; basic equations for one-dimensional compressible flow, isentropic flow relations; area-velocity relation; normal shock waves, relation between upstream and downstream flow parameters.	4-1-0
2	<b>Gas Turbine Systems and Cycles:</b> System of operation of gas turbines-constant volume and constant pressure gas turbines; thermodynamics of Brayton cycle; regeneration- inter-cooling, reheating and their combinations; closed cycle and semi-closed cycle gas turbines; gas turbine v/s I.C engines and steam turbines.	4-2-0
3	<b>Compressors:</b> Classification-positive displacement and dynamic compressors, Operation of single stage reciprocating compressors; isothermal efficiency; volumetric efficiency; multi-stage compression. Centrifugal compressors; principle of operation; work done and pressure rise; diffuser; compressibility effects; non dimensional quantities for plotting compressor characteristics; compressor characteristics. Axial flow compressors; basic operation; elementary theory; factors effecting stage pressure ratio; degree of reaction; calculation of stage performance; Axial flow characteristics.	6-2-0
4	<b>Combustion Systems:</b> Types, operational requirements; combustion process; factors affecting combustor design; combustion chamber performance; Gas turbine emissions.	4-1-0
5	<b>Air-breathing Propulsion Systems:</b> Principle of jet propulsion; analysis and performance characteristics of turbojet, turboprop, ramjet and pulsejet; thrust power and propulsion efficiency	4-1-0
	<b>Rocket Propulsion:</b> Operating principle; solid and liquid propellants, performance analysis-calculations for specific impulse and propulsive efficiency.	5-1-0

CODE	COURSE NAME	CATEGORY	L	T	P	CREDIT
MET458	ADVANCED ENERGY ENGINEERING	PEC	2	1	0	3

**Preamble:** This course provides basic ideas about various energy source and its environmental impacts.

**Prerequisite :** Nil

**Course Outcomes :** After completion of the course the student will be able to

CO1	Explain the concept of various types of power generation
CO2	Explain solar and wind power generation and its economics
CO3	Explain biomass energy sources and its economics
CO4	Explain various renewable energy sources
CO5	Explain environmental impacts of various energy generation

**Mapping of course outcomes with program outcomes**

	PO 1	PO 2	PO 3	PO 4	PO 5	PO 6	PO 7	PO 8	PO 9	PO 10	PO 11	PO 12
CO 1	3	1										
CO 2	3	1										
CO 3	3	1										
CO 4	3	1										
CO 5	3	1				1	1					
CO 6	3	1										

Bloom's Category	Continuous Assessment Tests		End Semester Examination
	1	2	
Remember	10	10	10
Understand	20	20	20
Apply	20	20	70
Analyse			
Evaluate			
Create			

**Mark distribution**

<b>Total Marks</b>	<b>CIE</b>	<b>ESE</b>	<b>ESE Duration</b>
150	50	100	3 hours

**Continuous Internal Evaluation Pattern:**

Attendance	: 10 marks
Continuous Assessment Test (2 numbers)	: 25 marks
Assignment/Quiz/Course project	: 15 marks

**End Semester Examination Pattern:** There will be two parts; Part A and Part B. Part A contain 10 questions with 2 questions from each module, having 3 marks for each question. Students should answer all questions. Part B contains 2 questions from each module of which student should answer any one. Each question can have maximum 2 sub-divisions and carry 14 marks.

**Course Level Assessment Questions:****Course Outcome 1 (CO1):**

1. Discuss the renewable energy potential of India.
2. Explain briefly global energy resources.
3. Explain the working and components of a thermal power plant with the help of a neat layout.

**Course Outcome 2 (CO2):**

1. Explain briefly about the different types of solar collectors with neat sketches.
2. Explain the working of solar photovoltaic cells.
3. List the different methods used to estimate wind speed at a location.
4. Discuss site selection for wind power plants?

**Course Outcome 3 (CO3):**

1. Which are the main sources of Biomass?
2. With a neat sketch explain the working of a fixed dome type biogas plant.
3. Explain the biochemical and thermo chemical methods of biomass conversion.

**Course Outcome 4 (CO4):**

1. Explain the working principle of MHD power generation with a sketch.
2. Explain the components and working principle of any one hybrid power plant with sketches.
3. With the help of a neat diagram explain the working principle and applications of fuel cells.

**Course Outcome 5 (CO5):**

1. Explain any three methods for controlling air pollution by thermal power plants.
2. What is cause for the loss of biodiversity and how is biodiversity protected?
3. Describe the actions to be taken for sustainability of energy.

**Model Question Paper**

**APJ ABDUL KALAM TECHNOLOGICAL UNIVERSITY  
VI SEMESTER B.TECH DEGREE EXAMINATION  
MET458: ADVANCED ENERGY ENGINEERING**

**Maximum: 100 Marks****Duration: 3 hours****PART A****Answer all questions, each question carries 3 marks**

1. Elaborate on the current global energy supply scenario.
2. What are the renewable energy resources? Discuss their importance in India's power requirement contest.
3. Explain the basic principle of wind energy conversion.
4. Distinguish between active and passive solar energy systems.
5. Explain the category of biomass resources.
6. "Energy released from biomass comes from Sun". elaborate on this point
7. Mention the impact of tidal energy power plants in the environment
8. Name the different processes used for Hydrogen production.
9. What is biodiversity?
10. List any four sources of land degradation ( 10 X 3 = 30 marks)

**PART B****Answer one full question from each module****Module 1**

11. (i) Sketch the layout of a diesel power plant. Explain the layout. (10 marks)
- (ii) How do Industry Nation and Globe would benefit from energy efficiency programs. (4 marks)

**OR**

12. Give the schematic layout of a thermal power plant and explain its working with the help of Rankine cycle (14 marks)

**Module 2**

- 13 Explain briefly about the different types of solar collectors with neat sketches. (14 marks)

**OR**

14. (i) Elaborate on the construction and working of the different types of horizontal axis wind turbine. (10 marks)
- (ii). What are the advantages of wind energy conversion systems? (4 marks)

**Module 3**

15. (i) Explain the biochemical and thermo chemical methods of biomass conversion (10 marks)  
(ii) What is the difference between biomass and biogas? (4 marks)

**OR**

16. (i).With a neat sketch explain the working of a fixed dome type biogas plant. (10 marks)  
(ii). Write a short note on gasification of biomass? (4 marks)

**Module 4**

17. With the help of a schematic diagram explain the closed cycle MHD and open cycle MHD (14 marks)

**OR**

- 18.With the help of a neat diagram explain the working principle and applications of fuel cells. (14 marks)

**Module 5**

- 19.(i).Briefly explain any four air pollutants and their effects (8 marks)  
(ii) Explain the causes and effects of eutrophication (6 marks)

**OR**

- 20 (i).Define Global warming. What are the reasons for Global warming? (10 marks)  
(ii). List out the environmental impact of utilizing hydroelectric power (4 marks)

Estd.



2014

## Syllabus

### Module 1

Introduction to the course, Global and Indian energy resources. Energy demand and supply. components, layout and working principles of steam, hydro, nuclear, gas turbine and diesel power plants .

### Module 2

Solar Energy- passive and active solar thermal energy, solar collectors, solar thermal electric systems, solar photovoltaic systems, economics of solar power  
Wind Energy-Principle of wind energy conversion system, wind turbines, aerodynamics of wind turbines, wind power economics, Introduction to solar-wind hybrid energy

### Module 3

Biomass Energy – Biomass as a fuel, thermo-chemical, bio-chemical and agro-chemical conversion of biomass- pyrolysis, gasification, combustion and fermentation, transesterification, economics of biomass power generation, future prospects

### Module 4

Other Renewable Energy sources – Brief account of Geothermal, Tidal, Wave, MHD power generation. Fuel cells – general description, types, applications. Hydrogen energy conversion systems, hybrid systems- Economics and technical feasibility

### Module 5

Environmental impact of energy conversion – ozone layer depletion, global warming, greenhouse effect, loss of biodiversity, eutrophication, acid rain, air and water pollution, land degradation, thermal pollution, Sustainable energy, promising technologies, development pathways

### Text Books:

1. P K Nag, Power Plant Engineering, TMH, 2002
2. Jefferson W Tester, Sustainable Energy Choosing among options, PHI, 2006
3. Tiwari G N, Ghosal M K, Fundamentals of renewable energy sources, Alpha Science International Ltd., 2007

### Reference Books:

1. David Merick, Richard Marshall, Energy, Present and Future Options, Vol.I & II, John Wiley & Sons, 2001
2. Godfrey Boyle, Renewable Energy : Power for a Sustainable Future, Oxford University Press, 2012
3. Herbert E. Merritt, Hydraulic control systems, John Wiley & Sons, 2012
4. Roland Wengenmayr, Thomas Buhrke, 'Renewable Energy: Sustainable energy concepts for the future, Wiley – VCH, 2012
5. Twidell J W and Weir A D, Renewable Energy Resources, UK, E&F.N. Spon Ltd., 2006

**Course Contents and Lecture Schedule**

<b>No.</b>	<b>Topic</b>	<b>No. of Lectures</b>
<b>I</b>	Introduction to the course, Global and Indian energy resources. Energy demand and supply. Components, layout and working principles of steam, hydro, nuclear, gas turbine and diesel power plants	<b>7</b>
<b>II</b>	Solar Energy- passive and active solar thermal energy, solar collectors, solar thermal electric systems, solar photovoltaic systems, economics of solar power	<b>6</b>
	Wind Energy-Principle of wind energy conversion system, wind turbines, aerodynamics of wind turbines, wind power economics, Introduction to solar-wind hybrid energy	<b>5</b>
<b>III</b>	Biomass Energy – Biomass as a fuel, thermo-chemical, bio-chemical and agro-chemical conversion of biomass-pyrolysis, gasification, combustion and fermentation, transesterification, economics of biomass power generation, future prospects	<b>6</b>
<b>IV</b>	Other Renewable Energy sources – Brief account of Geothermal, Tidal , Wave, MHD power generation. Fuel cells – general description, types, applications. Hydrogen energy conversion systems, hybrid systems- Economics and technical feasibility	<b>6</b>
<b>V</b>	Environmental impact of energy conversion – ozone layer depletion, global warming, greenhouse effect, loss of biodiversity, eutrophication, acid rain, air and water pollution, land degradation, thermal pollution, Sustainable energy, promising technologies, development pathways`	<b>6</b>

Estd.



2014

CODE	COURSE NAME	CATEGORY	L	T	P	CREDIT
MET468	ADDITIVE MANUFACTURING	PEC	2	1	0	3

**Preamble:** This course addresses additive manufacturing principles, variety and its concept, scope of additive manufacturing and areas of application

**Prerequisite:** NIL

**Course Outcomes:** After the completion of the course the student will be able to

CO Nos	Course Outcomes	Level of learning domain
CO 1	Discuss various additive manufacturing processes	2
CO 2	Explain slicing operations in additive manufacturing	2
CO 3	Use liquid and solid based additive manufacturing system	3
CO 4	Select powder based and use of pre requirement of AM	2
CO 5	Apply rapid prototyping techniques for obtaining solutions	3

**Mapping of course outcomes with program outcomes**

	PO 1	PO 2	PO 3	PO 4	PO 5	PO 6	PO 7	PO 8	PO 9	PO 10	PO 11	PO 12
CO 1	2				2		2					1
CO 2	3	2			2		2					1
CO 3	2				2		2					1
CO 4	2				2		2					1
CO 5	3	2			2		2					1

**Assessment Pattern**

Bloom's Category	Continuous Assessment Tests		End Semester Examination
	1	2	
Remember	25	25	25
Understand	35	35	35
Apply	40	40	40
Analyse			
Evaluate			
Create			

**Mark distribution**

<b>Total Marks</b>	<b>CIE</b>	<b>ESE</b>	<b>ESE Duration</b>
150	50	100	3 hours

**Continuous Internal Evaluation Pattern:**

Attendance	: 10 marks
Continuous Assessment Test (2 numbers)	: 25 marks
Assignment/Quiz/Course project	: 15 marks

**End Semester Examination Pattern:** There will be two parts; Part A and Part B. Part A contain 10 questions with 2 questions from each module, having 3 marks for each question. Students should answer all questions. Part B contains 2 questions from each module of which student should answer any one. Each question can have maximum 2 sub-divisions and carry 14 marks.

**Course Level Assessment Questions****Course Outcome 1 (CO1):**

1. What is additive manufacturing?
2. What is STL file?
3. What is AM process chain?

**Course Outcome 2 (CO2)**

1. What is Model Slicing?
2. What are the softwares used for Tool path generation
3. What are the softwares currently used for AM?
4. What are the limitations of Tool path generation?

**Course Outcome 3(CO3):**

1. Brief the post processing types of LENS.
2. What are process variables in FDM?
3. What are the applications of EDM?

**Course Outcome 4 (CO4):**

1. What is STL file?
2. How does 3d Printing Work?
3. What are the merits of SLM?

**Course Outcome 5 (CO5):**

1. What are the benefits of rapid tooling?
2. What are the applications of rapid tooling?
3. What is Rapid Tooling?

**Model Question Paper****MET 468 ADDITIVE MANUFACTURING****Max. Marks : 100****Duration : 3****Hours****Part – A****Answer all questions, each question carries 3 marks**

1. Write a note on product development by AM?
2. Classify and Explain of additive manufacturing processes?
3. Brief about Support structure design?
4. What are the advantages of Part orientation?
5. Brief the LOM process.
6. What are the materials used in SLS
7. What are the strength and weakness of 3DP?
8. What are the merits of SLM?
9. What are the fundamentals of Rapid Prototyping?
10. List the types of industries that RP can be used in industrial applications?

**PART -B****Answer one full question from each module.****MODULE – 1**

- 11 a) Write a note on the benefits and applications of AM. (6 marks)  
 b) Write a note on the impact of AM on product development. (8 marks)

**OR**

12. a) Write a note on the need and development of AM systems. (8 marks)  
 b) Classify and explain the AM process. (6 marks)

**MODULE – 2**

13. a) Explain about data formats and data interfacing? (6 marks)  
 b) What is part orientation? Explain with illustrations? (8 marks)

**OR**

14. a) Explain the need of support generation with flow charts? (8 marks)  
 b) What are the steps involved in model slicing? (6 marks)

**MODULE – 3**

15. a) Brief about strength, Weakness and applications of SLA? (8 marks)  
b) Explain the working principle and process variables of FDM. (6 marks)

**OR**

16. a) Brief about strength, Weakness and applications of SLS? (8 marks)  
b) Explain the working principle and process variables of LOM. (6 marks)

**MODULE – 4**

- 17.a) Explain the working principle and process variables of 3DP (6 marks)  
b) Compare solid, liquid and powder based system of 3DP. (8 marks)

**OR**

- 18 a) what is STL Format? Explain any two translators used in place of STL? (8 marks)  
b) Explain the working principle and process variables of 3DP? (6 marks)

**MODULE – 5**

- 19 a) what are the benefits of using color in production of medical models? (6 marks)  
b) What AM materials are already approved for medical applications and for what types of application are they suitable? (8 marks)

**OR**

- 20 a) Discuss the steps followed in rapid prototyping process. (6 marks)  
b) What is rapid tooling and explain the applications of RPT in manufacturing and tooling. (8 marks)



**SYLLABUS****Module 1**

Introduction to Additive manufacturing: Importance of Additive Manufacturing- Basic principle of additive manufacturing- Procedure of product development in additive manufacturing. Classification of additive manufacturing processes, Materials used in additive manufacturing- Benefits & Challenges in Additive Manufacturing.

**Module 2**

Basic Concept — Digitization techniques — Model Reconstruction — Data Processing for Additive Manufacturing Technology: CAD model preparation — Part Orientation and support generation — Model Slicing — Tool path Generation- Introduction to slicing softwares: Cura.

**Module 3**

Principle, process parameters, advantages and applications of: Fused Deposition Modelling (FDM), Selective Laser Sintering (SLS), Stereo Lithography (SLA). Laminated Object Manufacturing (LOM), Electron Beam Melting (EBM), Laser Engineering Net Shaping (LENS),

**Module 4**

Principle, process parameters, advantages and applications of: Selection Laser Melting (SLM), Jetting, 3D Printing-STL Format, STL File Problems, consequence of building valid and invalid tessellated models, STL file Repairs: Generic Solution, other Translators, Newly Proposed Formats.

**Module 5**

Direct processes: - Rapid Prototyping, Rapid Tooling. Rapid Manufacturing; Indirect Processes: - Indirect Prototyping. Indirect Tooling, Indirect Manufacturing. Applications and case studies of Additive Manufacturing: –Biomedical- Manufacturing- Aerospace-Automotive- Food- Electronics.

**Text Books**

1. Gibson, I, Rosen, D W., and Stucker,B., Additive Manufacturing Methodologies: Rapid Prototyping to Direct Digital Manufacturing, Springer, 2010
2. Chua C.K., Leong K.F., and Lim C.S., “Rapid prototyping: Principles and applications”, Third Edition, World Scientific Publishers, 2010
3. Chee Kai Chua, Kah Fai Leong, 3D Printing and Additive Manufacturing: Principles and Applications: Fourth Edition of Rapid Prototyping, World Scientific Publishers, 2014
4. Gebhardt A., “Rapid prototyping”, Hanser Gardener Publications, 2003

**Reference Books**

1. Liou L.W. and Liou F.W., “Rapid Prototyping and Engineering applications: A tool box for prototype development”, CRC Press, 2007
2. Kamrani A.K. and Nasr E.A., “Rapid Prototyping: Theory and practice”, Springer, 2006
3. Mahamood R.M., Laser Metal Deposition Process of Metals, Alloys, and Composite Materials, Engineering Materials and Processes, Springer International Publishing AG 2018

4. Ehsan Toyserkani, Amir Khajepour, Stephen F. Corbin, “Laser Cladding”, CRC Press, 2004  
 5. Christopher Barnatt, “3D Printing”, Explaining The Future.com, 2014.
6. Paul F Jacobs, “Stereolithography and other RP&M Technologies: from Rapid Prototyping to Rapid Tooling”, Society of Manufacturing Engineers and the Rapid Prototyping Association, New York, 1996.

### Course Contents and Lecture Schedule

No	Topic	No. of Lectures
<b>MODULE 1</b>		
1.1	Introduction to Additive manufacturing: Importance of Additive Manufacturing	2
1.2	Basic principle of additive manufacturing- Procedure of product development in additive manufacturing.	2
1.3	Classification of additive manufacturing processes, Materials used in additive manufacturing	2
1.4	Benefits & Challenges in Additive Manufacturing.	1
<b>MODULE 2</b>		
2.1	Basic Concept — Digitization techniques — Model Reconstruction	1
2.2	Data Processing for Additive Manufacturing Technology:	1
2.3	CAD model preparation — Part Orientation and support generation	1
2.4	Model Slicing — Tool path Generation	1
2.5	Introduction to slicing softwares: Cura.	2
<b>MODULE 3</b>		
3.1	Principle, process, advantages and applications of: Fused Deposition Modelling(FDM),	1
3.2	Principle, process, advantages and applications of: Selective Laser Sintering(SLS), Stereo Lithography(SLA),	2
3.3	Principle, process, advantages and applications of: Laser Engineering Net Shaping (LENS)	2
3.4	Principle, process, advantages and applications of: Laminated Object Manufacturing (LOM), Electron Beam Melting (EBM).	2
<b>MODULE 4</b>		
4.1	Principle, process, advantages and applications of: Selection Laser Melting (SLM), Jetting, 3D Printing	2
4.2	Principle, process, advantages and applications of 3D Printing	2
4.3	STL Format, STL File Problems, consequence of building valid and invalid tessellated models,	2
4.4	STL file Repairs: Generic Solution, other Translators, Newly Proposed Formats.	1
<b>MODULE 5</b>		
5.1	Direct processes: - Rapid Prototyping, Rapid Tooling. Rapid	2

	Manufacturing	
5.2	Indirect Processes: - Indirect Prototyping, Indirect Tooling, Indirect Manufacturing.	2
5.3	Applications and case studies of Additive Manufacturing: –Biomedical-Manufacturing-	2
5.4	Applications and case studies of Additive Manufacturing: –Aerospace-Automotive- Food- Electronics.	2

APJ ABDUL KALAM  
TECHNOLOGICAL  
UNIVERSITY



CODE	COURSE NAME	CATEGORY	L	T	P	CREDIT
MET478	POWER PLANT ENGINEERING	PEC	2	1	0	3

**Preamble:** Power Plant Engineering basically focuses on power generation principles for real world applications. This course is focused on application of energy principles and power generation cycles. The main purpose of implementing this course in curriculum is to learn about how the power is generated in a power plant and its applications

**Prerequisite:** MET205 THERMODYNAMICS, MET303 THERMAL ENGINEERING

**Course Outcomes:** After the completion of the course the student will be able to

CO 1	Explain the layout, construction and working of the components inside a thermal power plant
CO 2	Explain the layout, construction and working of the components inside a Diesel, Gas and Combined cycle power plants.
CO 3	Explain the layout, construction and working of the components inside nuclear power plants.
CO 4	Explain the layout, construction and working of the components inside Renewable energy power plants.
CO 5	Identify applications of power plants, plant economics, environmental hazards and estimate the costs of electrical energy production.

#### Mapping of course outcomes with program outcomes

	PO 1	PO 2	PO 3	PO 4	PO 5	PO 6	PO 7	PO 8	PO 9	PO 10	PO 11	PO 12
CO 1	2	2	2									
CO 2	2	2	2									
CO 3	2	2	2									
CO 4	2	2	2									
CO 5	2	2	2									

#### Assessment Pattern

Bloom's Category	Continuous Assessment Tests		End Semester Examination
	1	2	
Remember	10	10	20
Understand	30	30	60
Apply	10	10	20
Analyse			
Evaluate			
Create			

**Mark distribution**

<b>Total Marks</b>	<b>CIE</b>	<b>ESE</b>	<b>ESE Duration</b>
150	50	100	3 hours

**Continuous Internal Evaluation Pattern:**

Attendance	: 10 marks
Continuous Assessment Test (2 numbers)	: 25 marks
Assignment/Quiz/Course project	: 15 marks

**End Semester Examination Pattern:** There will be two parts; Part A and Part B. Part A contain 10 questions with 2 questions from each module, having 3 marks for each question. Students should answer all questions. Part B contains 2 questions from each module of which student should answer any one. Each question can have maximum 2 sub-divisions and carry 14 marks.

**Course Level Assessment Questions****Course Outcome 1 (CO1):**

1. Comment on the methods used for handling of coal.
2. State the advantages and disadvantages of pulverized coal firing.
3. Illustrate and explain the functions of cooling tower.

**Course Outcome 2 (CO2)**

1. State the applications of diesel electric power plants.
2. List the components present in the diesel electric power plants.
3. Illustrate and explain working of a regenerative gas turbine and re-heater with a help of a Pv diagram.

**Course Outcome 3(CO3):**

1. List down the basic factors to be considered for the design of a nuclear power reactor
2. Give example for the components of pressurized water reactor nuclear power plan.
3. Describe the functionality of moderator.

**Course Outcome 4 (CO4):**

1. Enumerate the advantages and disadvantages of hydropower plants.
2. Comment on different types of ocean thermal energy conversion system.

3. Explain in detail about the various types of Wind energy system.

**Course Outcome 5 (CO5):**

1. Illustrate and explain the load duration curve.
2. A power station has two 60MW units each running for 1500 hours a year. The energy produced per year is  $700 \times 10^6$  kW-hr. Calculate the plant load factor and plant use factor.
3. Define depreciation and elaborate its role in operation of a power plant.

**Model Question Paper**

**APJ ABDUL KALAM TECHNOLOGICAL UNIVERSITY**

**EIGHTH SEMESTER B.TECH DEGREE EXAMINATION**

**Course Code: MET478**

**Course Name: POWER PLANT ENGINEERING**

Max. Marks: 100

Duration: 3 Hours

**PART – A**

**(ANSWER ALL QUESTIONS, EACH QUESTION CARRIES 3 MARKS)**

1. Define drift? How drift is eliminated in cooling towers?
2. Comment on the types of burner employed for pulverized coals in the thermal power plants.
3. What are the methods of cooling in a diesel engine power plant?
4. List out the difference between open cycle and closed cycle gas turbine plant.
5. Mention the advantages of nuclear power plant.
6. Define “half-life” of nuclear fuels.
7. Comment on the working of a solar cell.
8. What are the advantages and limitations of tidal power plant?
9. Define the importance of capital cost in a power plant.
10. Define load factor and list out methods for improvement in load factor.

**PART – B**

**(ANSWER ONE FULL QUESTION FROM EACH MODULE)**

**MODULE – 1**

11. a) Explain the analysis of pollution from thermal power plants. (7 marks)

b) How ash is handled in the power plant? Explain the ash handling system. (7 marks)

OR

12. a) Explain the principle involved in preparation of coal and what are the methods of preparation? (7 marks)

b) Illustrate and explain the working different types of cooling towers. (7 marks)

**MODULE – 2**

13. a) Give the layout of diesel engine power plant. What are the advantages and disadvantages of diesel power plants? (7 marks)

b) List out the difference between the closed cycle and open cycle gas turbine power plants (7 marks)

OR

14. a) Illustrate and explain working of a regenerative gas turbine and re-heater with help of a P-v diagram (7 marks)

b) What are the methods used for improving the efficiency of a gas turbine plant? (7 marks)

**MODULE – 3**

15. a) Explain with neat sketches and with examples difference between controlled and uncontrolled chain reaction? (7 marks)

b) Describe the boiling water reactor with the help of neat sketch and explain its chief characteristics (7 marks)

OR

16. a) Explain the working of a typical fast breeder nuclear reactor power plant, with the help of neat diagram (7 marks)

b) Define commonly used methods of nuclear waste disposal and discuss their salient features. (7 marks)

**MODULE – 4**

17. a) Explain the factors to be considered while selecting the site of a hydro power plant? (7 marks)

b) Explain the construction and working of Geo thermal power plant (7 marks)

OR

18. a) Explain with a neat diagram of wind electric generating power plant. (7 marks)
- b) Explain in detail about the various types of Wind energy system. (7 marks)

**MODULE – 5**

19. A central power station has annual factors as follows: Load factor = 60%, Capacity factor = 40%, Use factor = 45%, Power station has a maximum demand of 15,000 kW. Determine: Annual energy production, Reserve capacity over and above peak load, Hours per year not in service. (14 marks)

OR

20. a) What are the elements which contribute to the cost of the electricity? How can the cost power generation be reduced? (7 marks)
- b) Define power plant economics? Explain the fixed and operating cost of a power station (7 marks)



## Syllabus

### Module 1

#### COAL BASED THERMAL POWER PLANTS

Rankine cycle – improvisations, Layout of modern coal power plant, Super Critical Boilers, FBC Boilers, Turbines, Condensers, Steam & Heat rate, Subsystems of thermal power plants – Fuel and ash handling, Draught system, Feed water treatment. Binary Cycles and Cogeneration systems.

### Module 2

#### DIESEL, GAS TURBINE AND COMBINED CYCLE POWER PLANTS

Otto, Diesel, Dual & Brayton Cycle – Analysis & Optimisation. Components of Diesel and Gas Turbine power plants. Combined Cycle Power Plants. Integrated Gasifier based Combined Cycle systems.

### Module 3

#### NUCLEAR POWER PLANTS

Basics of Nuclear Engineering, Layout and subsystems of Nuclear Power Plants, Working of Nuclear Reactors : Boiling Water Reactor (BWR), Pressurized Water Reactor (PWR), CANada Deuterium- Uranium reactor (CANDU), Breeder, Gas Cooled and Liquid Metal Cooled Reactors. Safety measures for Nuclear Power plants.

### Module 4

#### POWER FROM RENEWABLE ENERGY

Hydro Electric Power Plants – Classification, Typical Layout and associated components including Turbines. Principle, Construction and working of Wind, Tidal, Solar Photo Voltaic (SPV), Solar Thermal, Geo Thermal, Biogas and Fuel Cell power systems.

### Module 5

#### ENERGY, ECONOMIC AND ENVIRONMENTAL ISSUES OF POWER PLANTS

Power tariff types, Load distribution parameters, load curve, Comparison of site selection criteria, relative merits & demerits, Capital & Operating Cost of different power plants. Pollution control technologies including Waste Disposal Options for Coal and Nuclear Power Plants.

### Text Books

1. P.C.Sharma, “Power Plant Engineering”, S.K.Kataria Publication, 3<sup>rd</sup> Edition, 2015.
2. Arora and S. Domkundwar , “A Course in Power Plant Engineering”, Dhanpat rai & Co Publication, 5<sup>th</sup> Edition, 2016.
3. P.K. Nag, “Power Plant Engineering”, TMH Publication, 4<sup>th</sup> Edition, 2017.

**Reference Books**

1. R.K. Rajput, “A Text Book of Power Plant Engineering”, Laxmi Publications, 5<sup>th</sup> Edition, 2016.
2. K. K. Ramalingam, “Power plant Engineering”, Scitech Publishers, 2<sup>nd</sup> Edition, 2015
3. G.D. Rai, “An Introduction to Power Plant Technology”, Khanna Publishers, 3<sup>rd</sup> Edition, 2011.
4. C. Elanchezhian , “Power Plant Engineering” , I.K. International Publications, 2<sup>nd</sup> Edition, 2013.

**Course Contents and Lecture Schedule**

No	Topic	No. of Lectures
1	<b>COAL BASED THERMAL POWER PLANTS</b>	
1.1	Rankine cycle – improvisations	1
1.2	Layout of modern coal power plant, Super Critical Boilers, FBC Boilers	2
1.3	Turbines, Condensers, Steam & Heat rate, Subsystems of thermal power plants.	2
1.4	Fuel and ash handling, Draught system.	2
1.5	Feed water treatment. Binary Cycles and Cogeneration systems	1
2	<b>DIESEL, GAS TURBINE AND COMBINED CYCLE POWER PLANTS</b>	
2.1	Otto, Diesel, Dual & Brayton Cycle – Analysis & Optimisation.	2
2.2	Components of Diesel and Gas Turbine power plants.	2
2.3	Combined Cycle Power Plants.	2
2.4	Integrated Gasifier based Combined Cycle systems.	2
3	<b>NUCLEAR POWER PLANTS</b>	
3.1	Basics of Nuclear Engineering, Layout and subsystems of Nuclear Power Plants, Working of Nuclear Reactors	2
3.2	Boiling Water Reactor (BWR), Pressurized Water Reactor (PWR), CANada Deuterium- Uranium reactor (CANDU),	2
3.3	Breeder, Gas Cooled and Liquid Metal Cooled Reactors.	2
3.4	Safety measures for Nuclear Power plants.	2
4	<b>POWER FROM RENEWABLE ENERGY</b>	
4.1	Hydro Electric Power Plants – Classification, Typical Layout and associated components including Turbines.	2
4.2	Principle, Construction and working of Wind, Tidal, Solar Photo Voltaic (SPV), Solar Thermal, Geo Thermal, Biogas and Fuel Cell power systems.	4
5	<b>ENERGY, ECONOMIC AND ENVIRONMENTAL ISSUES OF POWER PLANTS</b>	
5.1	Power tariff types, Load distribution parameters, load curve, Comparison of site selection criteria, relative merits & demerits,	2
5.2	Capital & Operating Cost of different power plants.	2
5.3	Pollution control technologies	2

APJ ABDUL KALAM  
TECHNOLOGICAL  
UNIVERSITY

**SEMESTER VIII**

**MINOR**



MED482	MINI PROJECT	CATEGORY	L	T	P	CREDIT
		PWS	0	0	3	4

**Preamble:** Mini Project Phase I: A Project topic must be selected either from research literature or the students themselves may propose suitable topics in consultation with their guides. The object of Project Work I is to enable the student to take up investigative study in the broad field of Mechanical Engineering, either fully theoretical/practical or involving both theoretical and practical work to be assigned by the Department on a group of three/four students, under the guidance of a Supervisor. This is expected to provide a good initiation for the student(s) in R&D work. The assignment to normally include:

- ◆ Survey and study of published literature on the assigned topic;
- ◆ Preparing an Action Plan for conducting the investigation, including team work;
- ◆ Working out a preliminary Approach to the Problem relating to the assigned topic;
- ◆ Block level design documentation
- ◆ Conducting preliminary Analysis/ Modelling/ Simulation/ Experiment/ Design/ Feasibility;
- ◆ Preparing a Written Report on the Study conducted for presentation to the Department;

CO1	Identify and synthesize problems and propose solutions to them.
CO2	Prepare work plan and liaison with the team in completing as per schedule.
CO3	Validate the above solutions by theoretical calculations and through experimental
CO4	Write technical reports and develop proper communication skills.
CO5	Present the data and defend ideas.

#### Mapping of course outcomes with program outcomes

	PO1	PO2	PO3	PO4	PO5	PO6	PO7	PO8	PO9	PO10	PO11	PO12
CO1	3	3	3	3					3	3		2
CO2	3			3				3	3	3	3	
CO3	3	3	3	3	3					3		
CO4					3			3	3	3		1
CO5	3	3	3	3				3		3	3	1

\*1-slight/low mapping, 2- moderate/medium mapping, 3-substantial/high mapping

## Assessment Pattern

The End Semester Evaluation (ESE) will be conducted as an internal evaluation based on the product, the report and a viva- voce examination, conducted by a 3-member committee appointed by Head of the Department comprising HoD or a senior faculty member, academic coordinator for that program and project guide/coordinator. The Committee will be evaluating the level of completion and demonstration of functionality/specifications, presentation, oral examination, working knowledge and involvement.

The Continuous Internal Evaluation (CIE) is conducted by evaluating the progress of the mini project through minimum of TWO reviews. At the time of the 1<sup>st</sup> review, students are supposed to propose a new system/design/idea, after completing a thorough literature study of the existing systems under their chosen area. In the 2<sup>nd</sup> review students are expected to highlight the implementation details of the proposed solution. The review committee should assess the extent to which the implementation reflects the proposed design. A well coded, assembled and completely functional product is the expected output at this stage. The final CIE mark is the average of 1<sup>st</sup> and 2<sup>nd</sup> review marks.

A zeroth review may be conducted before the beginning of the project to give a chance for the students to present their area of interest or problem domain or conduct open brain storming sessions for innovative ideas. Zeroth review will not be a part of the CIE evaluation process.

## Marks Distribution

Total Marks	CIE	ESE
150	75	75

## Continuous Internal Evaluation Pattern:

Attendance : 10 marks  
Marks awarded by Guide : 15 marks  
Project Report : 10 marks  
Evaluation by the Committee : 40 Marks

**End Semester Examination Pattern:** The following guidelines should be followed regarding award of marks.

- (a) Demonstration : 50 Marks
- (b) Project report : 10 Marks
- (d) Viva voce : 15marks

## Course Plan

In this course, each group consisting of three/four members is expected to design and develop a moderately complex software/hardware system with practical applications. This should be a working model. The basic concept of product design may be taken into consideration.

Students should identify a topic of interest in consultation with Faculty-in-charge of miniproject/Advisor. Review the literature and gather information pertaining to the chosen topic. State the objectives and develop a methodology to achieve the objectives. Carryout the design/fabrication or develop codes/programs to achieve the objectives. Demonstrate the novelty of the project through the results and outputs. The progress of the mini project is evaluated based on a minimum of two reviews.

The review committee may be constituted by the Head of the Department. A project report is required at the end of the semester. The product has to be demonstrated for its full design specifications. Innovative design concepts, reliability considerations, aesthetics/ergonomic aspects taken care of in the project shall be given due weight.



APJ ABDUL KALAM  
TECHNOLOGICAL  
UNIVERSITY

**SEMESTER VIII**

**HONOURS**



MED496	MINI PROJECT	CATEGORY	L	T	P	CREDIT
		PWS	0	0	3	4

**Preamble:** Mini Project Phase I: A Project topic must be selected either from research literature or the students themselves may propose suitable topics in consultation with their guides. The object of Project Work I is to enable the student to take up investigative study in the broad field of Mechanical Engineering, either fully theoretical/practical or involving both theoretical and practical work to be assigned by the Department on a group of three/four students, under the guidance of a Supervisor. This is expected to provide a good initiation for the student(s) in R&D work. The assignment to normally include:

- ◆ Survey and study of published literature on the assigned topic;
- ◆ Preparing an Action Plan for conducting the investigation, including team work;
- ◆ Working out a preliminary Approach to the Problem relating to the assigned topic;
- ◆ Block level design documentation
- ◆ Conducting preliminary Analysis/ Modelling/ Simulation/ Experiment/ Design/ Feasibility;
- ◆ Preparing a Written Report on the Study conducted for presentation to the Department;

CO1	Identify and synthesize problems and propose solutions to them.
CO2	Prepare work plan and liaison with the team in completing as per schedule.
CO3	Validate the above solutions by theoretical calculations and through experimental
CO4	Write technical reports and develop proper communication skills.
CO5	Present the data and defend ideas.

#### Mapping of course outcomes with program outcomes

	PO1	PO2	PO3	PO4	PO5	PO6	PO7	PO8	PO9	PO10	PO11	PO12
CO1	3	3	3	3					3	3		2
CO2	3			3				3	3	3	3	
CO3	3	3	3	3	3					3		
CO4					3			3	3	3		1
CO5	3	3	3	3				3		3	3	1

\*1-slight/low mapping, 2- moderate/medium mapping, 3-substantial/high mapping

## Assessment Pattern

The End Semester Evaluation (ESE) will be conducted as an internal evaluation based on the product, the report and a viva- voce examination, conducted by a 3-member committee appointed by Head of the Department comprising HoD or a senior faculty member, academic coordinator for that program and project guide/coordinator. The Committee will be evaluating the level of completion and demonstration of functionality/specifications, presentation, oral examination, working knowledge and involvement.

The Continuous Internal Evaluation (CIE) is conducted by evaluating the progress of the mini project through minimum of TWO reviews. At the time of the 1<sup>st</sup> review, students are supposed to propose a new system/design/idea, after completing a thorough literature study of the existing systems under their chosen area. In the 2<sup>nd</sup> review students are expected to highlight the implementation details of the proposed solution. The review committee should assess the extent to which the implementation reflects the proposed design. A well coded, assembled and completely functional product is the expected output at this stage. The final CIE mark is the average of 1<sup>st</sup> and 2<sup>nd</sup> review marks.

A zeroth review may be conducted before the beginning of the project to give a chance for the students to present their area of interest or problem domain or conduct open brain storming sessions for innovative ideas. Zeroth review will not be a part of the CIE evaluation process.

## Marks Distribution

Total Marks	CIE	ESE
150	75	75

## Continuous Internal Evaluation Pattern:

Attendance : 10 marks  
Marks awarded by Guide : 15 marks  
Project Report : 10 marks  
Evaluation by the Committee : 40 Marks

**End Semester Examination Pattern:** The following guidelines should be followed regarding award of marks.

- (a) Demonstration : 50 Marks
- (b) Project report : 10 Marks
- (d) Viva voce : 15marks

## Course Plan

In this course, each group consisting of three/four members is expected to design and develop a moderately complex software/hardware system with practical applications. This should be a working model. The basic concept of product design may be taken into consideration.

Students should identify a topic of interest in consultation with Faculty-in-charge of miniproject/Advisor. Review the literature and gather information pertaining to the chosen topic. State the objectives and develop a methodology to achieve the objectives. Carryout the design/fabrication or develop codes/programs to achieve the objectives. Demonstrate the novelty of the project through the results and outputs. The progress of the mini project is evaluated based on a minimum of two reviews.

The review committee may be constituted by the Head of the Department. A project report is required at the end of the semester. The product has to be demonstrated for its full design specifications. Innovative design concepts, reliability considerations, aesthetics/ergonomic aspects taken care of in the project shall be given due weight.

